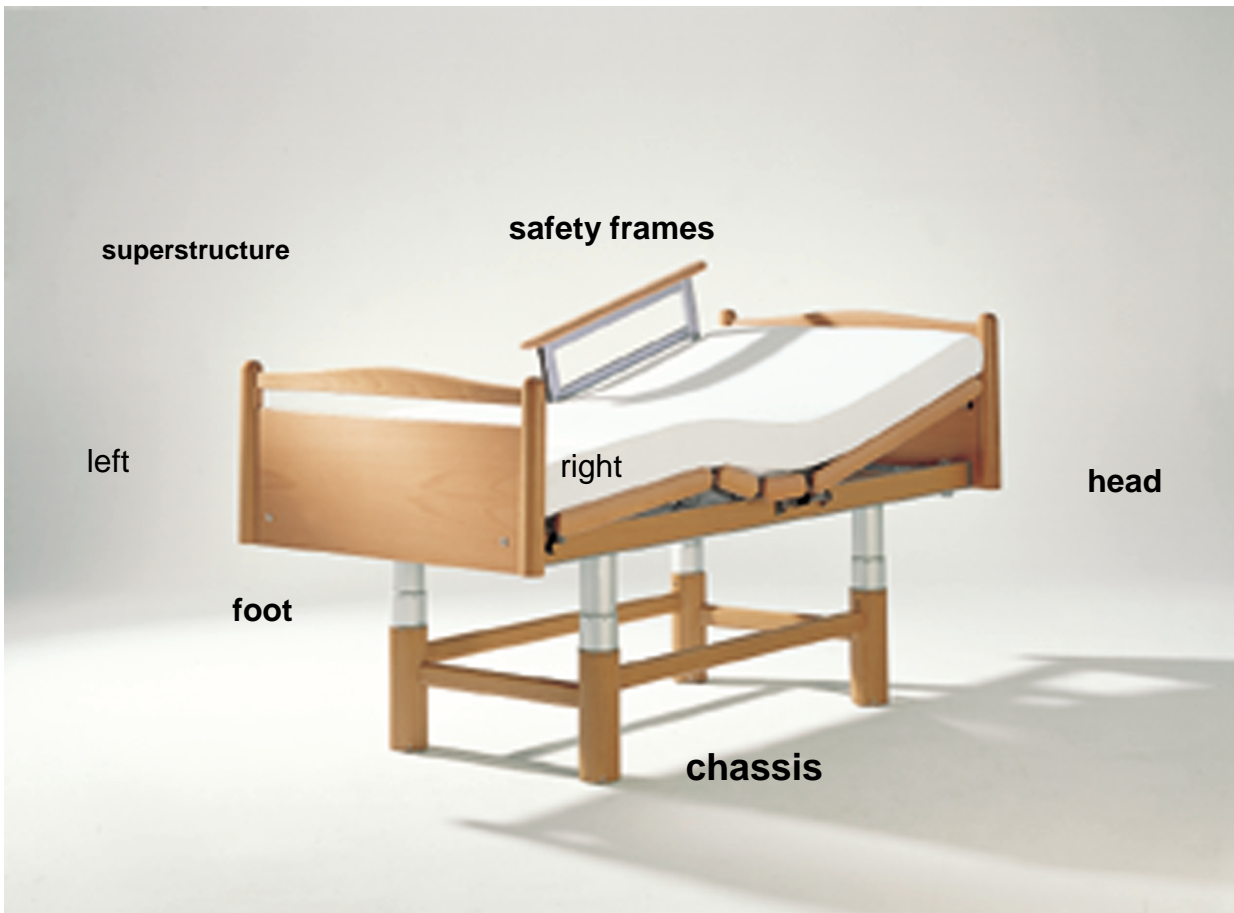


VOELKER NURSING BEDS
ASSEMBLY INSTRUCTIONS
MODELS 2080 AND 3080



Edition: October 2000-A

© **Völker GmbH** 2000

Völker GmbH

Wullener Feld 79
D-58454 Witten
GERMANY

Tel.: (0 23 02) 960 96 0
Fax: (0 23 02) 960 96 16
E-Mail: info@voelker.de
Internet: www.voelker.de

All rights reserved. No part of this publication may be reproduced, stored in or introduced into a retrieval system, or transmitted, in any form or by any means (electronic, mechanical, photocopying, recording or otherwise) either wholly or in part for any purpose whatsoever without the prior written permission of the publisher.

M-2 M-3

Table of contents

1.	General remarks.....	4
1.1	Copyright	4
1.2	Warranty and liability	4
2.	Safety regulations.....	5
2.1	Before beginning assembly	5
3.	Contents of cases and cartons.....	6
3.1	Model 3080:.....	6
3.2	Model 2080:.....	6
4.	Preparatory measures.....	7
4.1	Staff and space requirement; positioning of cases.....	7
5.	Assembly procedure, Models 2080 and 3080.....	8
5.1	Case “B” (head) and case “B” (foot)	8
5.2	OKIMAT	11
5.3	Case “A”	14
5.4	Fitting headboard and footboard	21
5.5	Model 2080: Fitting safety frames	22
5.6	Putting the bed in its final location	24

1. General remarks

You have purchased a Voelker nursing bed. This bed has been manufactured in compliance with German and European standards and regulations, and in accordance with current technical knowledge.

Voelker nursing beds meet all safety and functional requirements. They have been tested according to international specifications, and possess the CE Seal of Safety for Medical Products.

Nonetheless, please read the basic safety regulations in the operating instructions. Please also note — especially with regard to possible warranty claims — further information on subsequent pages.

These assembly instructions are intended to give customers practical information on the safe and correct assembly of the bed.

Everybody who is concerned with assembly work is required to have read the

- **safety regulations,**
- **assembly instructions,**
- **operating instructions.**

1.1 Copyright

These assembly instructions may only be made available to third parties with the express written permission of Voelker GmbH. All documentation is copyright protected.

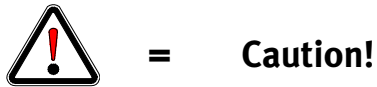
The transfer, copying and exploitation of documentation, also in part, is not permitted unless expressly agreed to in advance. Infringements are punishable in law and oblige the transgressor to pay damages. We reserve the right to exercise our rights in commercial law to the full.

1.2 Warranty and liability

We accept liability for possible defects or omissions — with the exclusion of all further claims — within the terms of the warranty entered into in the main contract. Claims for damages for whatever reason and on whatever legal ground are excluded.

We do not accept any liability whatsoever for damage and disruption caused by operating errors or by a failure to follow these assembly instructions.

Important information in the technical description is highlighted by the following symbol:



This information is to be read without fail and strictly adhered to.

We reserve the right to carry out alterations to the nursing beds dealt with in these assembly instructions in the light of technical developments.

2. Safety regulations

**These regulations are to be read without fail and strictly adhered to!
The safety regulations in the operating instructions are also to be read and adhered to!**



2.1 Before beginning assembly

Those responsible for assembling beds must read these assembly instructions in detail before beginning work.

Before beginning work, the responsible staff must be thoroughly instructed in the operation of the bed and be warned of possible dangers when assembling its component parts, as described in this manual.

The nursing beds are not explosion-resistant and for this reason they may only be assembled in areas free of inflammable materials.

3. Contents of cases and cartons

3.1 Model 3080:

- 1x case "A": 1 chassis, 1 carton OKIMAT
(1 OKIMAT + manual control unit, 2 lateral slides)
- 1x case "B": 1 mattress-frame (head),
1 head section
1 screw and/or fixing set Standard
1 screw and/or mounting set for head and foot section variants (not in case of all variants)
2 decorative slip-in strips
- 1x case "B": 1 mattress-frame (foot)
1 foot section
2 decorative slip-in strips

3.2 Model 2080:

- 1x case "A": 1 chassis, 1 carton OKIMAT
(1 OKIMAT + manual control unit, 2 lateral slides)
- 1x case "B": 1 mattress-frame (head),
1 head section
1 screw and/or fixing set Standard
2 decorative slip-in strips
- 1x case "B": 1 mattress-frame (foot)
1 foot section
2 decorative slip-in strips
- 1x case "C": 1 set safety frames

4. Preparatory measures

4.1 Staff and space requirement; positioning of cases

- We recommend that assembly is carried out by 2 people.
- Before beginning, clear enough floor space (ca. 3.50 x 2.50 m) for the 2 “B” cases to lie side by side as near as possible to the final position of the bed.
- Lay the “B” cases (check that the serial numbers are the same) on the floor with the opposing arrows pointing towards each other. The head and foot sections must be in the position in which the bed is to stand (see Figure 1).

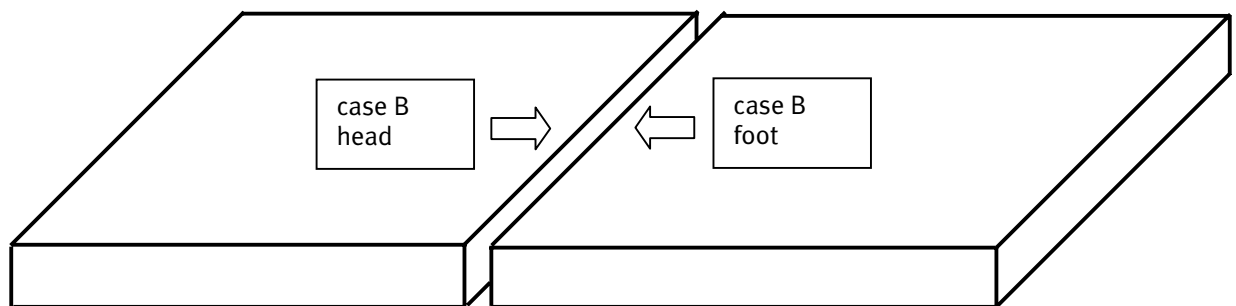


Figure 1

- Place case “A”, and for Model 2080 case “C”, within reach (see Figure 2).

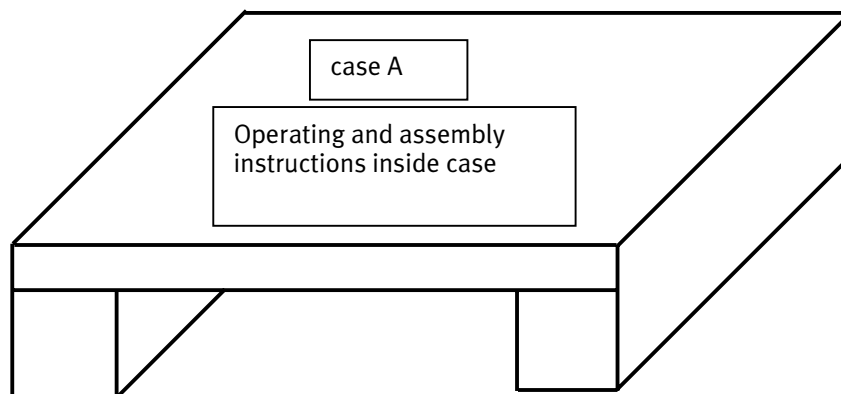


Figure 2

- Cut plastic tapes and lift flaps in upper part of cases “A” and “B”.

5. Assembly procedure, Models 2080 and 3080

5.1 Case "B" (head) and case "B" (foot)

- Fold down the adjacent ends of the "B" cases (see. Figure 3) to assemble the mattress-frame sections in this position. Remove further packing material when instructed to do so or after complete assembly.



mattress-frame head

mattress-frame foot

Figure 3

- Push over the head and foot section rotating shafts until they are resting on the underside of the mattress-frame sections (see Figure 4).

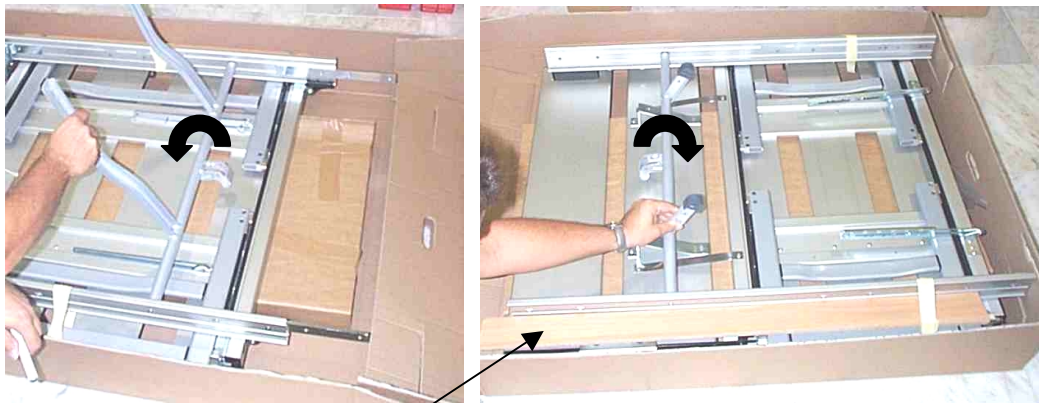


Figure 4

- Remove the decorative slip-in strips from the two cases and lay them to one side for later assembly.

- Push the head and foot sections of the mattress-frame together. This should be done without removing the packing material (see above) to avoid damaging wooden and aluminium surfaces (see Figure 5).

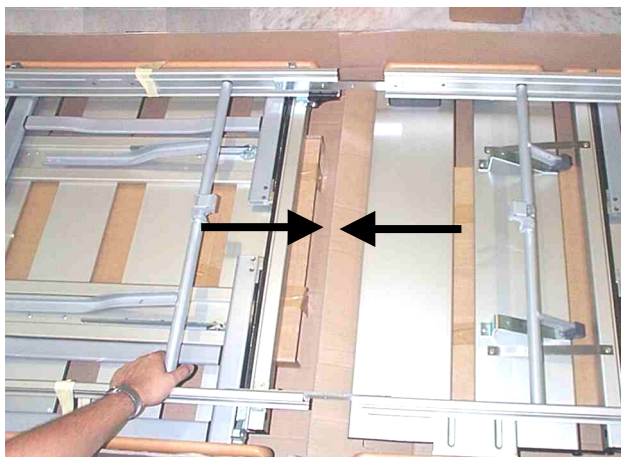


Figure 5

- Take care that the connecting piece already fitted to the head section is uniformly seated in the groove in the aluminium profile of the foot section. The centring bolts must be inserted into the drilled holes so that the aluminium profiles adjoin evenly and without a gap (see Figure 6).

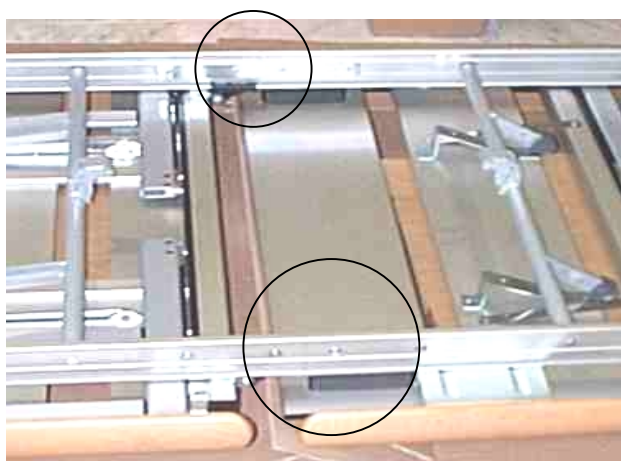


Figure 6

- In each case, insert 2x M8 x 10 – DIN 912 screws (see Figure 7) from the outside through the aluminium profile bearer into the steel connecting piece. Using an SW 6 Allan key (see Figure 8), turn clockwise and tighten (see Figure 9).



Finally check that all 8 screws of the connecting pieces are securely seated!



Figure 7



Figure 8



Figure 9

5.2 OKIMAT

- Remove main drive unit (OKIMAT) from case "A" (see Figure 10).



Figure 10

- Connect the 9V battery fitted to the OKIMAT casing to the contact clip and check that the battery is securely seated (see Figure 11). If necessary, push 9V battery firmly into its location.

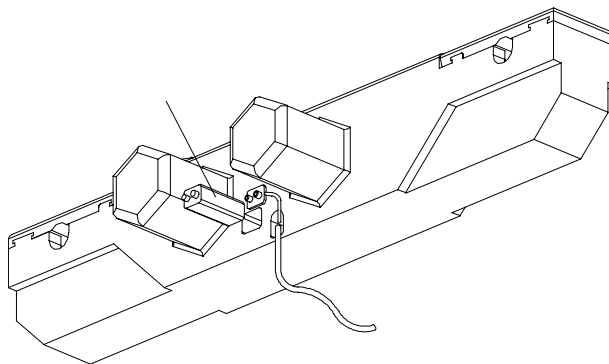


Figure 11

- The head/foot section identification mark or the symbols on the OKIMAT casing (see arrows, Figure 12) must coincide with the identification mark on the mattress-frame (head section to head section, foot section to foot section).



If assembled the wrong way round, the cable cannot be connected to the chassis!

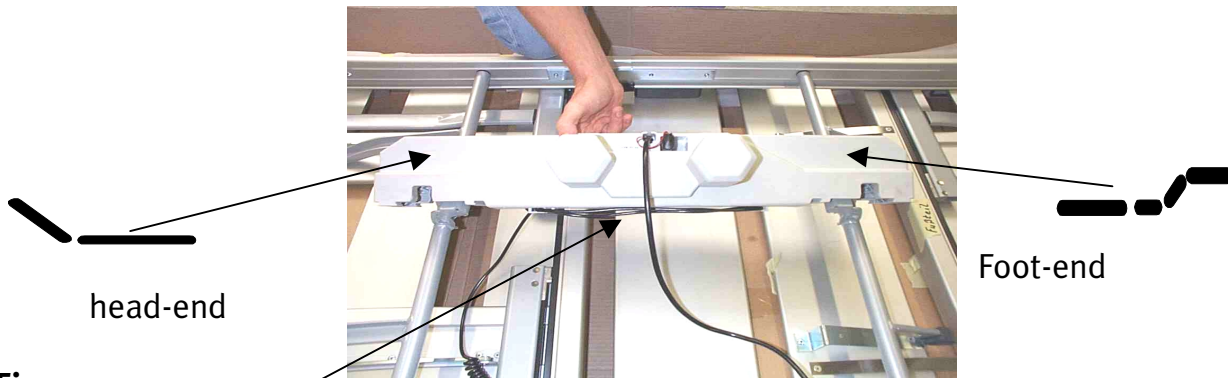


Figure 12

Sticker “head section/foot section”

- Lay OKIMAT on the rotating shaft with the opening downwards so that the control lever in the middle of the rotating shaft pokes up into the OKIMAT casing (see Figure 13).

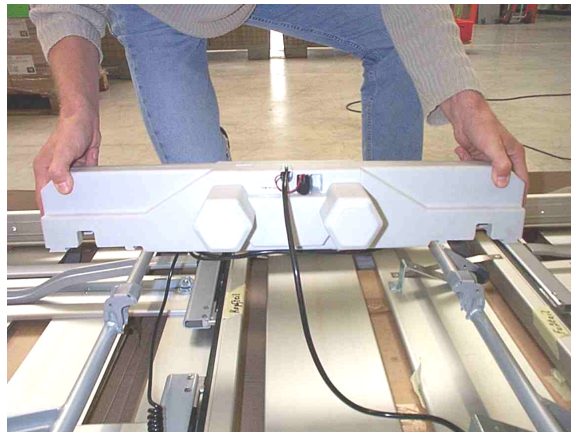


Figure 13

- Now press the OKIMAT casing down on to the rotating shafts firmly until you feel it click securely into position (see Figure 14)

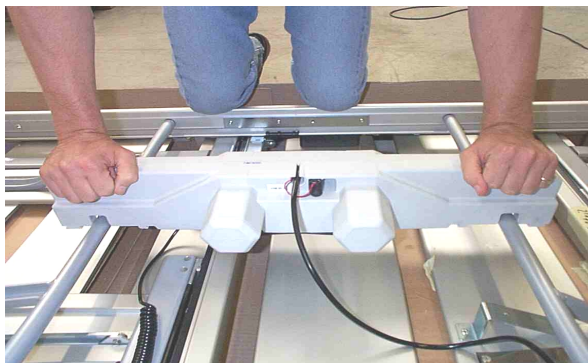


Figure 14

- Remove the 2 lateral slides from the box in which the OKIMAT was packed.
- Locate the slides below the rotating shafts opposite the fixing grooves on the underside of the OKIMAT casing and push them fully home (see Figure 15).

 **If stiff, push home with a rubber-headed hammer!**



Figure 15

- Swing the RASTOMATEN arms fitted to the foot-end of the mattress-frame over towards the outer wall of the case (see Figure 16).

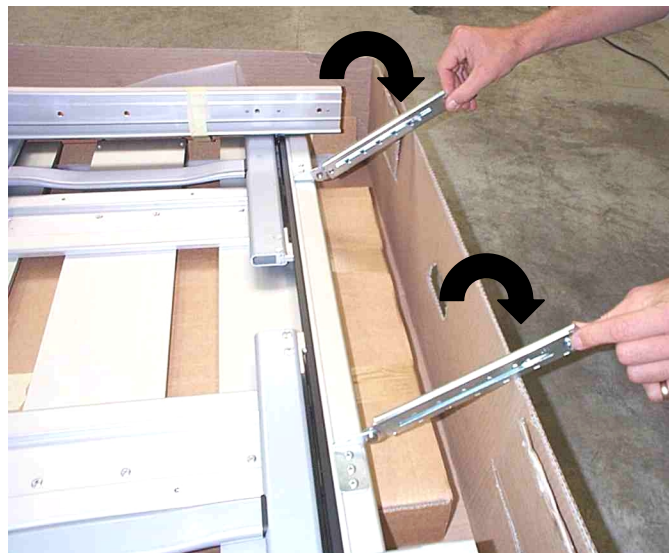


Figure 16

5.3 Case "A"

- Lift the chassis out of case "A" with the help of two people.
 - ⚠ **Take care that the identification mark „head- or foot-end“ coincides with the identification marks on the mattress-frame or make sure that the shorter of the two connecting cables is at the foot-end of the mattress-frame!**
- Place the chassis on to the superstructure with the castors pointing upwards. Make sure that the anchor points for fixing the chassis to the superstructure are situated at the prepared locations (fixing holes, countersinking) on the side bearers (see Figure 17).

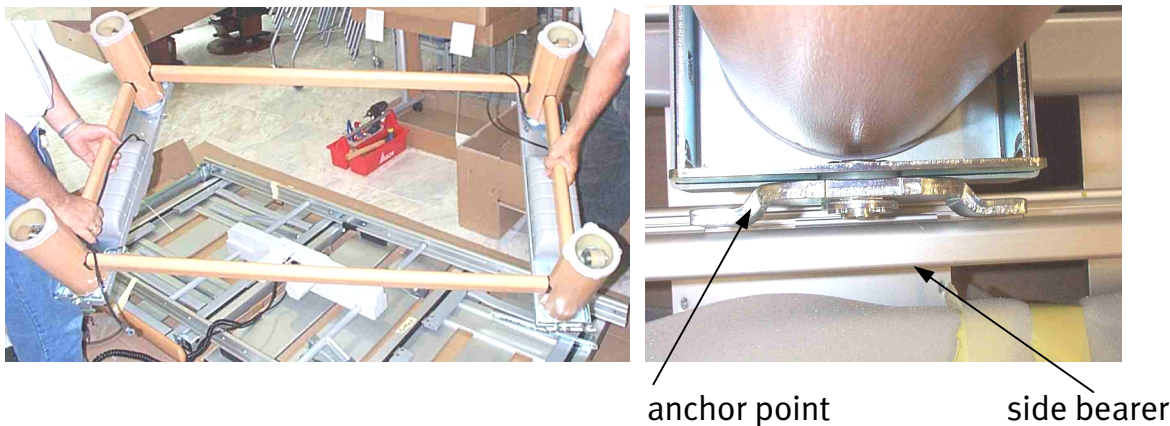


Figure 17

- Cut plastic tape at head-end.
- At head-end, push the two mattress displacement levers into the pivot holes in the tongues on the fixing bar (see arrow). If necessary, move head-end of mattress-frame for access (see Figure 18).

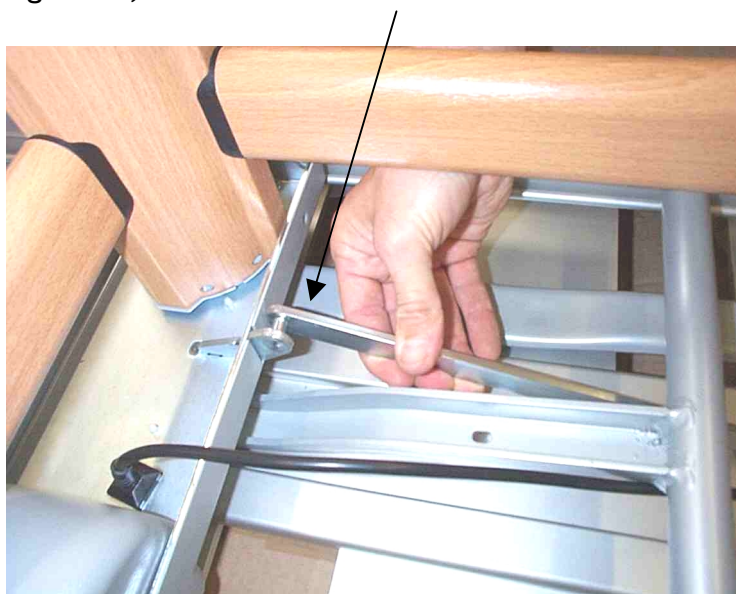


Figure 18

- Secure with spring cap (see Figure 19). Use flat-nosed or forged groove joint pliers to press the spring cap on to its location (see Figure 25).



Figure 19

- Then position the head-end anchor points so that they coincide with the drilled holes in the side bearers, left and right (see Figure 20).



Figure 20

- In each case, insert 2x M8 x 10 – DIN 912 screws (see Figure 21) from the outside through the aluminium profile bearer into the steel connecting piece. Using an SW 6 Allan key (see Figure 8), turn clockwise and tighten.



Figure 21

- Position the foot-end anchor points so that they coincide with the drilled holes in the side bearers. The anchor points can be moved within the locating groove.
- In each case, insert 2x M8 x 10 – DIN 912 screws (see Figure 21) from the outside through the aluminium profile bearer into the steel connecting piece. Using an SW 6 Allan key (see Figure 8), turn clockwise and tighten.



Finally check that all 8 screws of the connecting pieces are securely seated!

- Lead connecting cables from chassis to OKIMAT between mattress-frame and rotating shafts to sockets (see Figure 22).



Figure 22



Pay attention to the location of the plugs and to the symbols on them (Δ; □). Make sure that symbols on plugs and sockets are identical (see Figure 23)!

(If the head- and foot-end of mattress-frame have been assembled the wrong way round, one cable cannot be connected! In this case, check the relative locations of OKIMAT and chassis and if necessary correct it.)

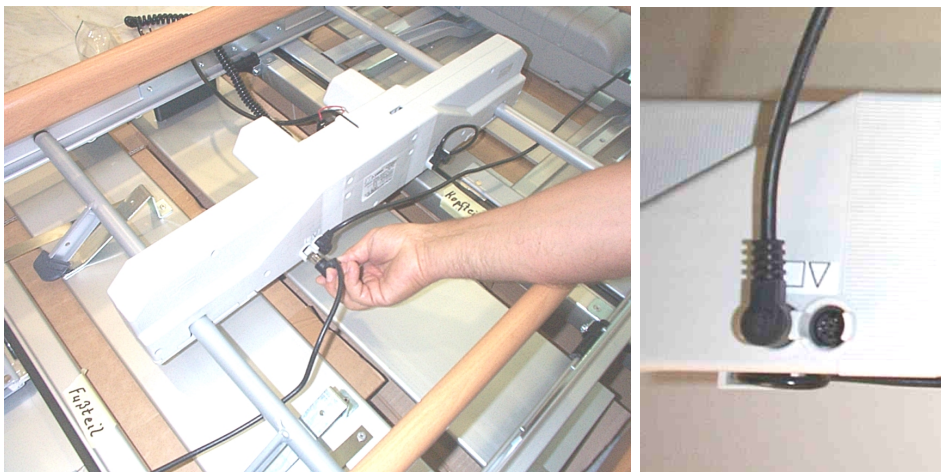


Figure 23

- If an optional Trendelenburg control box has been supplied, then proceed as described above. Here, too, pay attention to the plug and socket symbols.



The correct operation of the bed is only guaranteed when all 4 OKIMAT sockets are occupied by plugs with the appropriate symbol (X; O; Δ; □)!

- X** = dummy plug or Trendelenburg control box
- O** = manual control unit
- Δ** = head section
- = foot section

- Fold back the 2 (pull-out) RASTOMATEN, push on to pins on fixing bar on foot-end of chassis and secure with spring caps (see Figure 24).



The RASTOMAT can be extended telescopically. To telescope, first pull out to fullest extent, then push together again!

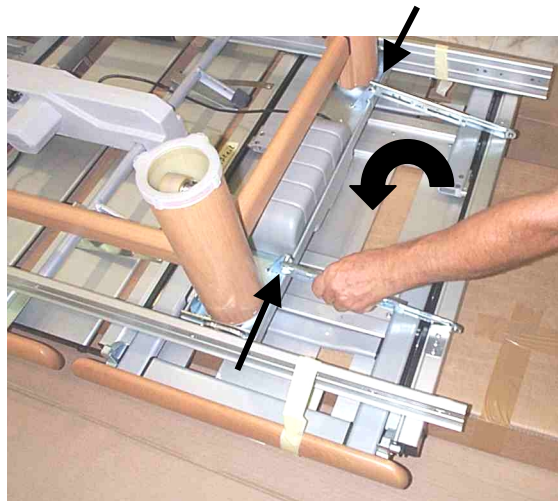


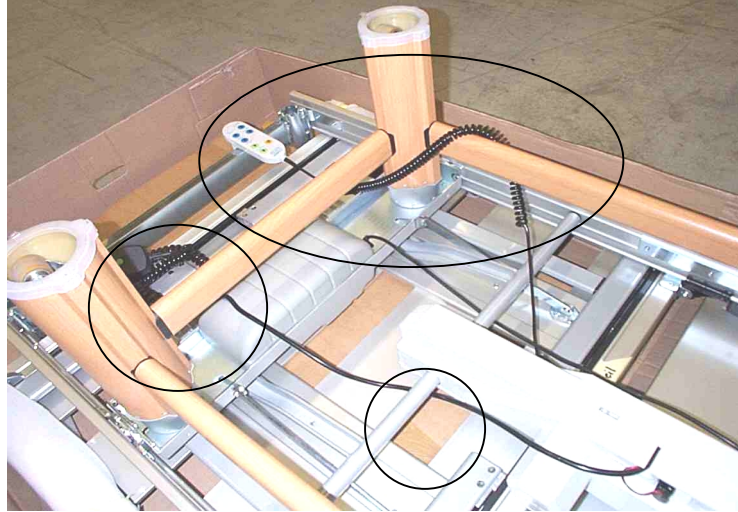
Figure 24

- Use flat-nosed or forged groove joint pliers to press the spring cap on to its location (see Figure 25).

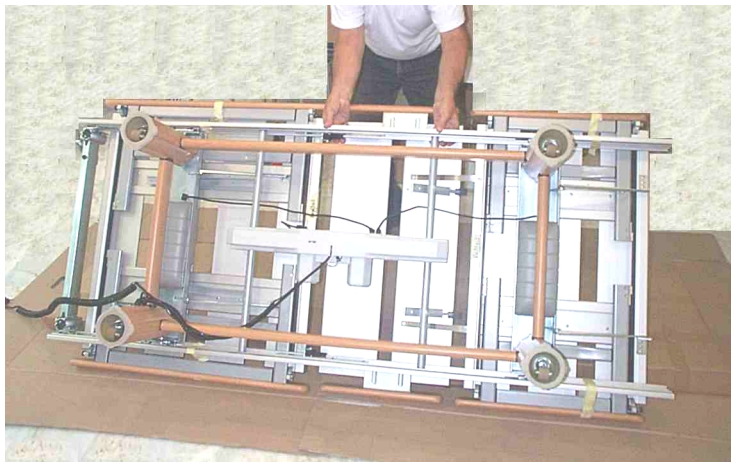


Figure 25

- Thread power and manual control unit cables to head end as shown so that they cannot be damaged when bed is turned upright (see Figure 26).

**Figure 26**

- Grasp the middle of the side bearer with both hands and stand bed up on its side (see Figure 27).

**Figure 27**

- Then go to the opposite side of the bed, holding it so that it cannot fall over.
- Grasp the middle of the side bearer with both hands and lower the bed gently on to its feet (see Figure 28).

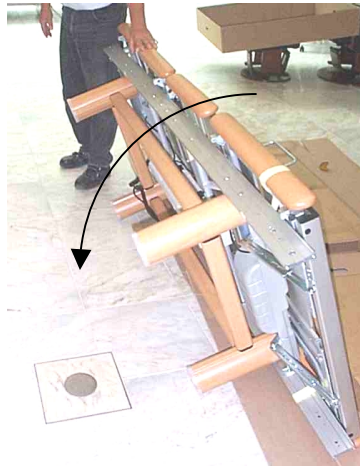


Figure 28

- Then cut plastic tape retaining safety frames and remove protective packing from head-end (see Figure 29).



Figure 29

- Press power cable into retaining groove at head-end. Take care that cable from OKIMAT to retaining groove is not taugt, but that it can be laid either side of OKIMAT casing in vicinity of rotating shaft (see Figure 30).



Figure 30

- Lead power cable out from beneath the bed immediately after it leaves its retaining groove. Lead manual control unit cable out to the left or right side (as required) between the chassis stretcher and the bed superstructure (see Figure 31).



Figure 31

- Cut plastic tape at foot-end.
- Push 2 slip-in strips into the side bearer profiles to the right and left with the decorated side facing outwards (see Figure 31).

5.4 Fitting headboard and footboard

- Screw 2 M8 threaded pins about 5 mm into the end-faces of each side bearer (see Figure 32).

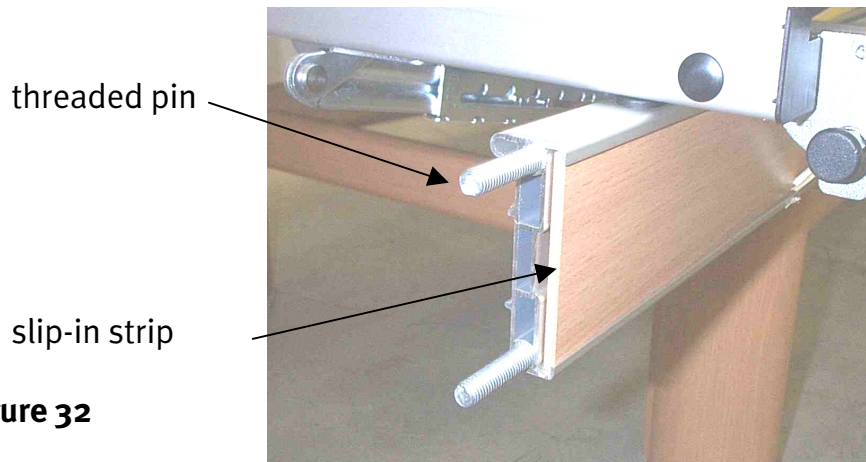


Figure 32

- Open the flat cartons with the words “headboard” and “footboard” lying in case “B” carefully to avoid damaging the wooden parts within them.
- Push the headboard with its 4 holes on to the threaded pins at the head-end of the bed. While holding, screw down the sleeve nuts clockwise with an SW5 Allan key until tight (see Figure 33).



CAUTION: Pay attention to the correct positioning of head- and footboard!
Model 2080: Make sure the safety frame slides are pointing towards the inside of the bed!



Figure 33

- To fit the footboard, proceed in the same way (s. Figure 33).

Note: Model 3080: Continuation at 5.6.

5.5 Model 2080: Fitting safety frames

- Connect bed to mains supply and raise it ca. 5 cm by activating “Lift” function (see Operating instructions).
- Open lid on end of case “C” and fold to one side. Remove safety frame set (see Figure 34).



Figure 34

- The screw at the end of each safety frame locking bar must point towards the inside of the bed (see Figure 35).



Figure 35

- Push the plastic tongues on the safety frames from below into the slides let into the head- and footboards (see Figure 36). A spring-loaded bolt in the lower end of the slide stops the safety frames from falling out so that first the one end, then the other, can be pushed in.

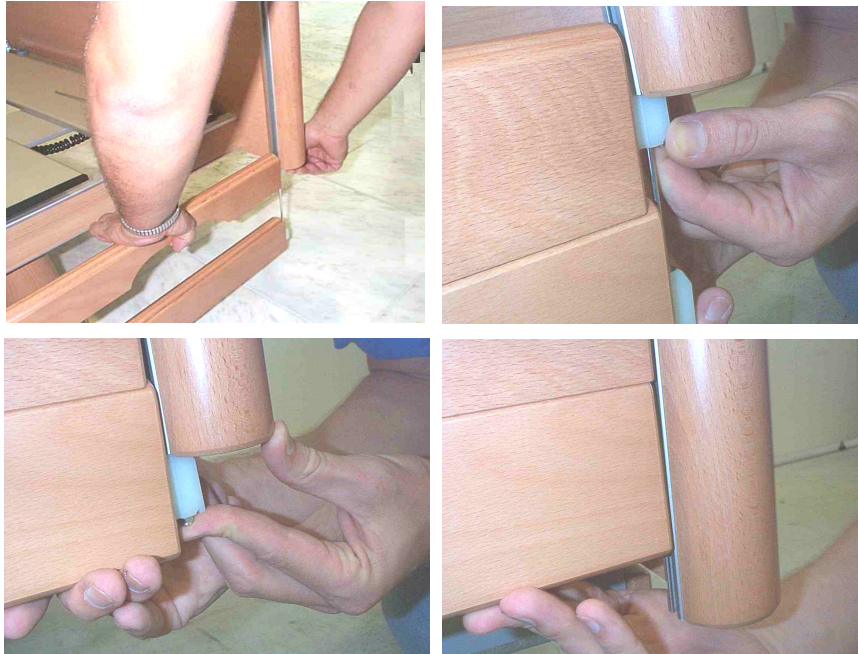


Figure 36

5.6 Putting the bed in its final location

- Push mains power plug into a mains socket.
- Use manual control unit to extend castors (see Operating instructions). Disconnect mains plug and feed cable over headboard, raise mattress-frame back section, lay mains plug over the cross-member and lower back section again (see Figure 37). In this way, the power plug cannot fall down during transport.

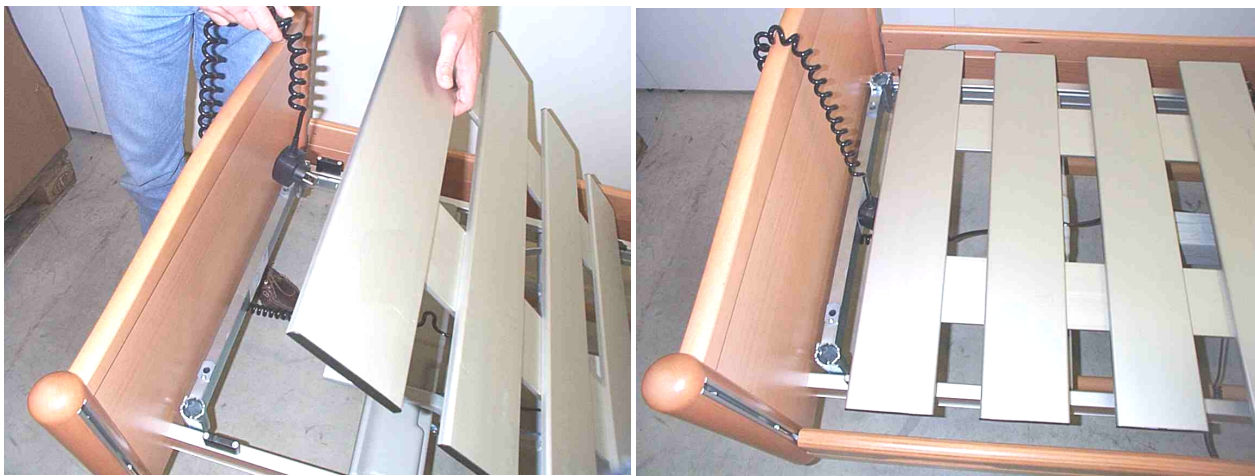


Figure 37

- Push the bed into the required position. Reconnect to mains power supply. Retract castors so that the bed is standing firmly on all four legs (see Operating instructions).



Please see the enclosed operating instructions for information on the correct operation of the bed and the functional test that must now be carried out!

Model 2080



Model 3080

