





Instructions for use  
Models 3082 Vis-a-Vis, 3082 K Vis-a-Vis

**VÖLKER**

# Help

## Hyperlinks

Hyperlinks are cross-references in the text. They are marked with the  symbol. Entries in the table of contents also have hyperlink functionality.

- Clicking  takes you to the relevant page.
- Clicking  in the Acrobat navigation bar takes you back to the start page.

## Full-text search for a term

- Clicking  Suchen opens the "Search" window.

You can search for any term in this Acrobat document or optionally search all of the Acrobat files stored on your computer or those that are accessible.

## Other interactive functions

The Adobe Reader and all Adobe Acrobat program versions offer the experienced user a whole raft of highly useful functions for interactive working with documents. For more information, see the relevant user manuals or online help.

*Display table of contents*



**Contents**

2 of 88

*Jump to Help page (this page)*



**Help**

# Version, Imprint, Type label

## Instructions for use G96

Version 1.4 (12.04.2012)

for Völker bed models 3082 Vis-a-Vis,

3082 K Vis-a-Vis

built after June 2009

© by Völker GmbH 2009-2012

Völker GmbH

Wullener Feld 79

58454 Witten

GERMANY

Tel.: +49 2302 96096-0

Fax: +49 2302 96096-16

e-mail: [info@voelker.de](mailto:info@voelker.de)

Internet: [www.voelker.de](http://www.voelker.de)

All rights reserved. Reproduction - even in part - is not permitted.

We reserve the right to make changes to reflect technical advances.

The contents of this document are subject to change without prior notification.

Customers are advised to contact the responsible area sales manager before placing an order.

## Type label

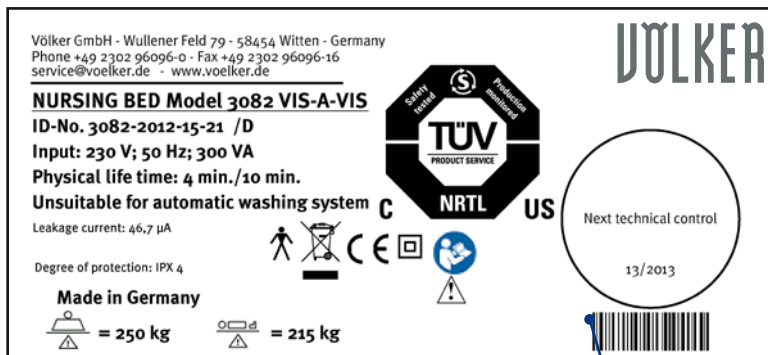

The type label is located on the inside of the head panel.

Raise the back section to read the type label.

For further information on the type label, see Appendix  72.



# Table of contents 1/2

Help  2

Version, Imprint, Type label  3

Table of contents  4

Foreword  6

## Notes 7

General information  8

Designated purpose  9

General regulations,  
training/instruction of users,  
further requirements  11

General safety notes  12

## Functional description 17

Overview  18

Transverse hand control  19

Nurse hand control  20

Trapeze bar and accessory holders,  
accessory rail  21

Versions and options  22

Accessories  23

## Activation 25

General operating instructions  26

Preparation  27

Electrical activation  29

Using the battery pack  30

Taking out of service  31

Functional check  32

## Operation 33

Key lock  34

Castors  35

Side rails  36

General safety notes  36

Side rails  37

Back section  39

Mech. rapid lowering of the back  
section / CPR function (option)  40

Upper and lower leg sections  41

Lying surface height  42

Anti-Trendelenburg and Trendelenburg  
positioning  43

Comfort seating position  44

Vis-a-Vis position  45

## Cleaning and disinfection 48

Cleaning  49

Wipe and spray disinfection  49

Spray lances and automatic  
washing systems  50

## Maintenance 51

Staff training  52

Safety notes  52

Maintenance schedule  54

## Technical check 55

Visual inspection  56

Functional check of the side rails  56

Functional check of the brakes  58

Functional check of the motors  58

Mains connection cable  58

Cabling  58

Housing  58

Mechanical check  58

Measuring in accordance with  
DIN EN 62353  59

Checking the trapeze bar grab  
handle  59

Further accessories  59

## Table of contents 2/2

### Troubleshooting 60

Table of faults  61

Service points  66

### Appendix 67

Symbols used  68

Technical data  69

Classification  71

Type label  72

Service life/disposal  74

Manufacturer's declarations, forms,  
electronic instructions for use  75

# Foreword

We are delighted that you have chosen Völker beds.

We are also grateful for the trust you have placed in our company and our products.

This step is undoubtedly the result of extensive considerations and examinations of the requirements that you require on new care or hospital beds based on your previous experiences.

You clearly had good reasons to choose Völker care beds.

We promise you that Völker beds will not disappoint you.

Not for nothing do Völker beds enjoy a worldwide reputation as particularly innovative medical aids. This refers not only to the design principle, which was completely redeveloped by Völker. It also refers to the multitude of product advantages which were continually tested and improved for their practicality. These will support the comfort of the occupant/patient and also help to reduce the load of daily care work.

Now, every care or hospital bed has product features that are of practical benefit to their users. However, as far as we know, none of them offers the range of advantages that a Völker bed does.

Völker beds not only look great, but they also offer functions that can be controlled or adjusted mechanically, although most of them are controlled or adjusted using electric motors or electronic components.

If you purchase these beds, the responsibility for their correct and appropriate use is transferred to you. Consequently, we strongly advise that you consult the enclosed instructions for use to learn about the technical features, handling and use of all the functions.

We wish you every success with Völker beds,

yours Völker GmbH

# Notes

The **Notes** section contains information on the designated purpose of the product, as well as general safety notes.



## CONTENTS

General information 📖 8

Designated purpose 📖 9

General regulations, training/  
instruction of users, further  
requirements 📖 11

General safety notes 📖 12

## General notes

You have purchased a bed from Völker GmbH. This bed has been built in accordance with the applicable national and international standards and the regulations reflecting the current state of technology.

Völker beds satisfy requirements in terms of safety and functionality. They are tested in accordance with international standards and bear the CE mark, which documents the beds' compliance with essential requirements for medical products.

Please read the general safety notes  12. Please also note (with particular attention to any warranty claims) the further notes on the following pages.

## Standard design

The standard design of the bed can be supplied with various options. A description of these options can be found in the section entitled Versions and Options  22.

## Copyright protection

These instructions for use may only be transferred to third parties with the written consent of Völker GmbH. All documents are protected under copyright.

## Warranty and liability

Völker GmbH is liable for any faults or failures, not including further claims, arising in the context of the warranty obligations detailed in the main agreement. Claims for compensation, for whatever legal reason such claims may be raised, will not be entertained.

We reserve the right to make technical modifications without notice as part of the further development of the beds which form the subject of these instructions for use. All specifications are non binding. Printing errors excepted.

We accept no liability for damage and operational faults caused as a result of misuse and/or non-observance of these instructions for use. We accept no liability for damage and operational faults caused as a result of misuse and/or non-observance of these instructions for use.

The portrayal of the accessories does not necessarily match the actual product.



## Notes | Designated purpose 1/2

### Intended use

Völker bed models 3082 Vis-a-Vis and 3082 K Vis-a-Vis are beds for medical use and are intended for the laying down and care of occupants/patients in care institutions, hospitals and in suitable rooms in residential buildings.

The bed is intended for use by people over the age of 12 or who are taller than 146 cm.

The bed's safe working load is 250 kg. To calculate the max. occupant/patient weight, 20 kg for the weight of the mattress and 45 kg for accessories as well as the load borne by the accessories must be subtracted from the safe working load in accordance with DIN EN 60601-2-52:2010 when using the bed in application environments 1 and 2 (intensive and acute care).

If using the bed in application environments 3, 4 and 5 (long-term, home and outpatient care), the values to be considered for the mattress are 20 kg and 15 kg for accessories as well as the load borne by the accessories.

The maximum occupant/patient weight can therefore be taken from the following table:

Model	Safe working load	Max. occupant/patient weight	
		in application environment 1, 2	in application environment 3, 4, 5
3082 Vis-a-Vis	250 kg	185 kg	215 kg
3082 K Vis-a-Vis	250 kg	185 kg	215 kg

Any use of the Völker bed other than for the purpose intended excludes the company from any possible liability.

## Notes | Designated purpose 2/2

### None intended use

None intended use can be dangerous. This includes, but is not limited to:

- Incorrect actuation of electrical functions and uncontrolled positioning
- Operation of the care bed by the occupant/patient without having received prior instruction in how to do so
- Use of other electrical equipment on the bed
- Pulling on cables to move the bed
- Removing electrical plug connections by pulling on the cable
- Use of the bed on a slope with more than ten degrees of inclination (the bed's brakes are designed for an angle of inclination of no more than ten degrees)
- Any attempt to move the bed while it is in braked position
- Use of the bed to transport people
- Use of the bed for transport with a vehicle
- Overloading of the bed beyond the specified safe working load.



**CAUTION** If, in an emergency situation, it is impossible to avoid putting children under the age of 12 or people who are less than 146 cm tall in the bed, protective covers must be placed on the side rails. This also applies to the use of the bed by weak or confused patients.

The use of the bed for children under the age of 8 is absolutely forbidden.



**WARNING** The bed may not be placed right next to or stacked up with other equipment. If operation near to or stacked up with other equipment is necessary, it must be ensured that the operation of the bed is observed and correct use in this arrangement is checked.

### General regulations

The bed must only be operated and used in accordance with its designated purpose, in line with the conditions of the Medical Products Directive (MPG) and approved legislation pursuant to this, the generally-acknowledged rules of technology and the stipulations of occupational safety and accident protection guidelines. The bed must **not** be operated in a faulty state that could endanger its occupant/patient, care personnel or third parties.

### User training

The bed may only be operated by individuals whose training or understanding and experience offer surety for correct handling (Medical Products Directive).

### User instruction

The thorough induction of care personnel in the operation of the bed can be provided by Völker or its representatives at the customer's request.

Attendance of such training can be certified and confirmed by Völker using the form provided for this purpose, specifying the name, date and signature.

Occupants/patients must be instructed in the use of the bed before care personnel hand over the hand control to them.

### Other requirements

Whoever is in charge of the activation, operation or preparation of the bed must have been given a copy of these instructions for use (in printed or electronic form) and have read them.

To avoid operating errors and to safeguard the smooth operation of the bed, care personnel must always have access to the safety notes below.

### Flooring requirements

Increasingly overweight patients and occupants have caused a consistent increase in demands on hospital and care beds in recent years. Völker has addressed this topic by increasing the "safe working load" for the beds. However, not only the beds are exposed to higher levels of strain, but also static and also flooring. Therefore, we recommend that flooring in areas where the beds are used which is designed for this strain. These are floor coverings classified as at least class 32 or 33 in accordance with DIN EN 685 and properly laid. These are floor coverings for areas intended for public and industrial use with moderate or heavy traffic.



### Warning symbols

Information marked with this symbol must be read and its content strictly observed.



**DANGER** represents an immediate threat of danger that can cause serious physical injury or death.



**WARNING** represents potentially dangerous situations that can lead to serious physical injury or death.



**CAUTION** represents potentially dangerous situations that can cause slight physical injuries.

**NOTE** warns of potential damage to objects or property.

### Before first activation

Before the bed is put into action for the first time, care personnel must read these instructions for use in full and with care.

Before the bed is activated for the first time, care personnel must be instructed in the handling of the bed using the instructions for use. The potential dangers that can arise despite correct operation of the bed must also be pointed out in full.

### Before and during use

Before each use of the bed, the user must be sure that the bed is in a good, safe condition and that safe use is ensured (Functional check  32).



**WARNING** If other devices are operated on the bed, which are provided with cables, air hoses or similar, make sure that these lines are routed so that they cannot become jammed in the moving parts or be damaged.

### Position of the bed





**CAUTION** To avoid injuries caused by falling, we recommend (except while care is being given) that the bed is generally set at its lowest position with the castors raised.



### Transporting the bed

-  **CAUTION** The bed is not designed for transporting people. When moving the bed, it must always be ensured that the mains connection cable does not touch the ground and that the lying surface is in a position as low as possible. The bed should only be moved on a solid floor. Never attempt to push it over obstacles of over 1 cm in height. The maximum angle of inclination of the floor must not exceed 10°.

### Securing the bed

-  **CAUTION "Risk of accident"** If the bed is not being transported, the castors must always be raised, since the bed may be required as a support for when the occupant/patient stands up or lies down. If the bed rolls away while the castors are down, this can lead to a serious fall. Once the castors have been raised  35, it must be checked that the bed is actually securely parked, i.e. the castors are completely raised. The bed can be in a non-fully-braked status even after first activation or reactivation, and consequently it must be checked that the castors are correctly raised.

### One-sided load on the bed

-  When using the bed as a normal clinic/care bed, the following applies: **NOTE** In order to prevent one-sided loads on the bed, it must not be used as a seat for persons other than the occupant/ patient (i.e. visitors must not sit on the edge of the bed).
-  **CAUTION** A maximum load of 80 kg on the lower leg section is permissible when the bed is in the fully extended Vis-a-Vis position!

### Side rails



#### **WARNING "Risk of entrapment"**

In the case of occupants/patients whose physical or mental condition makes it necessary to use side rails to protect them from falling out of bed, the following safety measures must be observed:

- The legal permissibility of using side rails must be ascertained.
- The side rails may only be operated by trained care personnel.
- Ensure that the side rails (or parts thereof) are either fully raised and locked in position or completely lowered.

- It must be ensured that the occupant/patient does not come into contact with the side rail elements when the electrical lying surface adjustment mechanism is actuated. It is also important to ensure that no part of the body is sticking out through the side rails.
- If the side rails are used with a person whose psychological condition makes their use necessary, then it must be ensured that the hand control is kept out of his/her reach or its functions are locked. In addition, it is strongly recommended that side rail covers are used.



- **DANGER** If these safety measures are not observed by care personnel, injuries can be caused to hands, knees, fingers, feet, legs and hips, along with haematomas and other injuries as a result of entrapment. In children or people who are less than 146 cm tall, non-observance of these guidelines can lead to death!



#### **WARNING "Danger of injury"**

If the side rails are damaged, the bed must not be used and must be repaired.

## Height adjustment

 **DANGER "Risk of entrapment between the lower frame and/or floor and the bed frame when the bed is lowered"**

It must be ensured that no people, limbs, pets, bed linen or other objects are caught between the bed frame and the lower frame and/or floor.

 **DANGER "Danger of movement"**  
If any movement of the bed could represent a danger to the occupant/patient, all functions must be locked.

## Accessories

 **WARNING "Risk of injury"**  
Only original Völker accessories should be used! Third-party accessories must be subjected to testing before use.

## Use of lifting devices

 **WARNING "Risk of injury"**  
No lifting device must be fastened directly to the bed (patient transport, repair).

The lifting devices specified are appliances that can be attached to the bed for transport purposes. Patient lifters can be used.

## Use of oxygen equipment

 **DANGER "Risk of fire"**  
Do not use any oxygen equipment other than that which is administered via nasal prongs or masks. Do not use this bed in a room where there is a risk of explosion.

Provided it has been excluded (e.g. based on information in the instructions for use of the equipment being used) that the use of the equipment may cause the O<sub>2</sub> concentration to rise to such a degree that there is an explosion risk, then the equipment can be used.

## Rail spacer

When using the rail spacer, please read the separate instructions for use for this accessory. During technical checks, the rail spacers should also be checked to ensure they are suitable for the size of side rail used.

## Notes | General safety notes 5/5

### Cleaning and disinfection

In order to maintain consistent functioning, the bed should be cleaned, disinfected and tested as soon as possible following each use, so that it can be reused immediately without risk.

Incorrect cleaning/disinfection  48 of the bed can cause danger.

### Maintenance and repair

Anyone responsible for carrying out maintenance and repair work must at least have taken part in a service training by Völker, have read the safety notes and the service manual and be qualified in accordance with MPBetreibV §§ 4 and 6.

After maintenance work or repairs have been carried out, a Technical check  55 must be carried out on the affected parts and/or functions. During this check, it must be determined that the bed can be used in accordance with the specifications without risk to occupants/pa-

tients, users or third parties.

The Technical check must be carried out at least once a year and after every lengthy period of non-use.

Any discernible damage, such as signs of wear and tear, loose screws or breaks/fractures must be eliminated immediately.

### Electromagnetic and electrostatic interference

The beds in model series 3082 Vis-a-Vis and 3082 K Vis-a-Vis satisfy the EMC requirements in accordance with the law on medical products (MPG). The basis for testing is standard EN 60601-1-2.



# Functional description

The features of the Völker care bed and its function are set out in the section **Functional description**.



## CONTENTS

- Overview 📖 18
- Transverse hand control 📖 19
- Nurse hand control 📖 20
- Trapeze bar and accessory holders, accessory rail 📖 21
- Versions and options 📖 22
- Accessories 📖 23

# Functional description | Overview

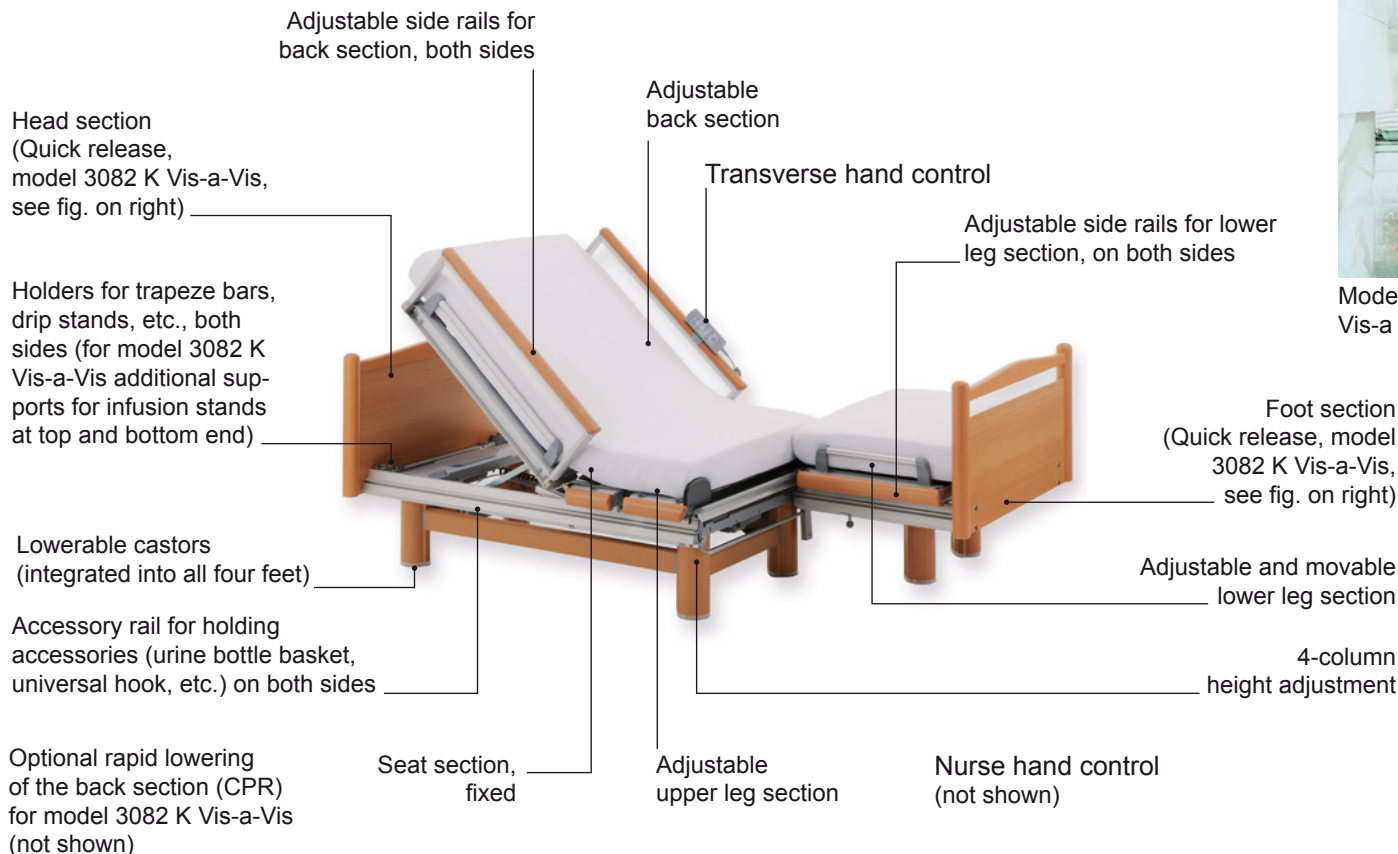

Model 3082 K Vis-a Vis

# Functional description | Transverse hand control

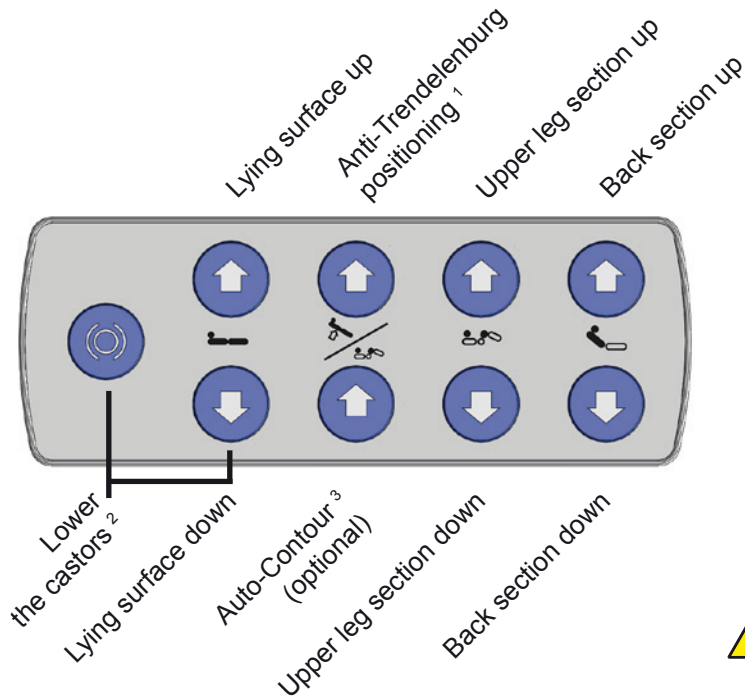

<sup>1</sup> Head end raised

<sup>2</sup> Press both buttons simultaneously:

the lying surface moves to the lowest position and the castors lower

<sup>3</sup> Back and upper leg section raised simultaneously

Reverse:

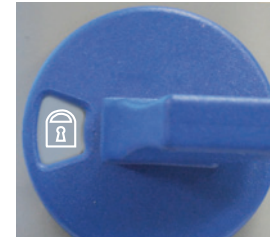

Hand control locked



Hand control unlocked



**WARNING** When actuating motorised adjustments with the side rails raised, it must be ensured that the occupant/patient does not have any contact with the side rails, and that no parts of his or her body or those of other people are sticking through the side rails or are trapped between the lying surface and the lower frame and/or floor!

# Functional description | Nurse hand control

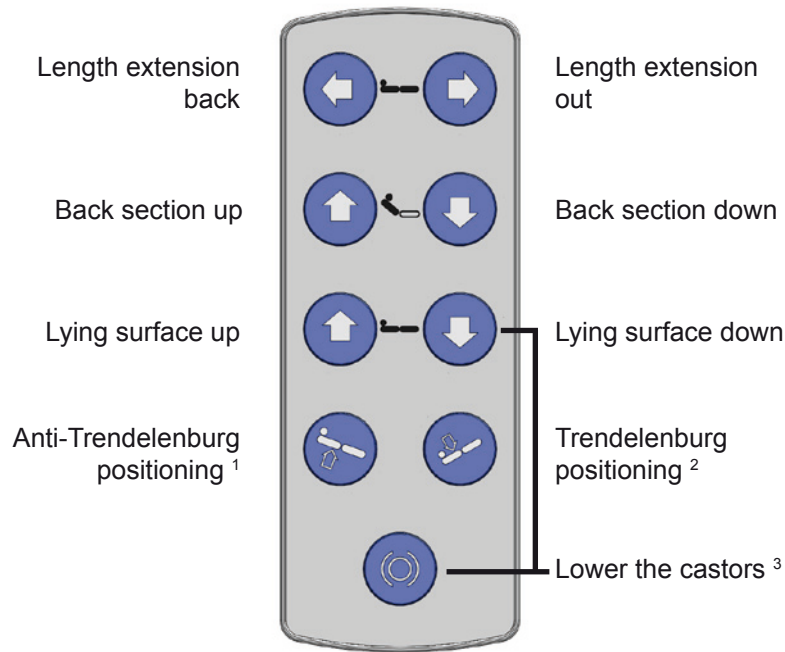

<sup>1</sup> Head end raised

<sup>2</sup> Head end lowered

<sup>3</sup> Press both buttons simultaneously:  
the lying surface moves to the lowest position and the castors lower.

Reverse:



Nurse hand control locked



Nurse hand control unlocked



**WARNING** When actuating motorised adjustments with the side rails raised, it must be ensured that the occupant/patient does not have any contact with the side rails, and that no parts of his or her body or those of other people are sticking through the side rails or are trapped between the lying surface and the lower frame and/or floor!

## Functional description | Trapeze bar and accessory holders, accessory rail

On the inside of the head panel are holders for the trapeze bar and accessories. On model 3082 K Vis-a-Vis, there are two additional sockets for drip stands at the head and foot ends, next to the protective wheels.

The trapeze bar and other accessories must be slotted into the holders until they audibly engage.



### **WARNING "Risk of injury"**

Ensure that the trapeze bar is completely slotted into the holder and securely seated.

Note: the safe working load of the trapeze bar is max. 75 kg.



### **WARNING "Risk of falling"**

The trapeze bar must not be used by the occupant/patient as an aid for climbing into the bed.

The trapeze bar must never jut out beyond the outer edge of the bed and then be used as a pulling-up aid (e.g. when getting out of a wheelchair).

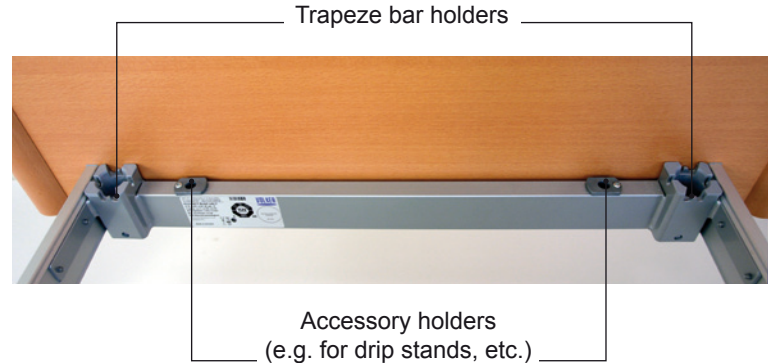

There is an accessory rail on either side of the bed to accommodate accessories.



**WARNING** Only original Völker trapeze bars should be used!

## Functional description | Versions and Options

The standard design of the bed can be supplied with various versions and options.

Version/option	Description
Hand control	Transverse on the side rail with clip:



There are different variants of hand controls with different function keys.

Nurse  
hand control

With hook:



Version/option	Description
----------------	-------------

Side rails (versions)	The bed can be equipped with various side rail versions:
--------------------------	--

Back/lower leg section\*:

1. Can be pulled out up to 34\* cm (standard)
2. Can be pulled out up to 37\* cm (option) (not possible with Design FS)
3. Can be pulled out up to 40\* cm (option)

\* Measured from the top edge of the side rails to the lying surface (without the mattress).

These instructions for use cover all of the versions and options listed.

Precise details of the supplied bed designs can be found in the order specifications for your beds. If the original bed specification is no longer available, please contact Völker Customer Services.

Please make a note of the Völker serial number (ID No.) on the type label  72 before you call.

## Functional description | Accessories 1/2

To offer the greatest possible degree of flexibility, Völker offers a wide range of easy-to-attach accessories. The care beds are equipped as standard with holder devices for accessories, such as drip stands and trapeze bars. Urine bottle baskets, universal hooks, standard bars, etc., can be mounted on the accessory rails provided on both sides of the bed.

Further information about accessories can be found in our current information brochure or on the Internet at [www.voelker.de](http://www.voelker.de). Our staff will gladly provide you with more details on the accessories that are available for your bed model.

### Mattresses (2-part)

#### Model 3082 Vis-a-Vis

Mattress size	Mattress frame size	Density
89/99 x 139.5+62 x 12 cm	90/100 x 200 cm (split)	40-50 kg/m <sup>3</sup>
89/99 x 139.5+72 x 12 cm	90/100 x 210 cm (split)	40-50 kg/m <sup>3</sup>
89/99 x 149.5+72 x 12 cm	90/100 x 220 cm (split)	40-50 kg/m <sup>3</sup>

#### Model 3082 K Vis-a-Vis

Mattress size	Mattress frame size	Density
89/99 x 139.5+65 x 12 cm	90/100 x 200 cm (split)	40-50 kg/m <sup>3</sup>
89/99 x 139.5+75 x 12 cm	90/100 x 210 cm (split)	40-50 kg/m <sup>3</sup>
89/99 x 149.5+75 x 12 cm	90/100 x 220 cm (split)	40-50 kg/m <sup>3</sup>

To minimise the risk of injury, only use mattresses with the dimensions and properties detailed above. If you do not use Völker mattresses, please contact a dealer in whom you have confidence.



**DANGER** If mattresses are used that do not match these specifications, there is a risk of suffocation!



**WARNING** Only original Völker accessories should be used! .

## Functional description | Accessories 2/2

**⚠ DANGER** The height of the raised side rails above the mattress must always be greater than or equal to 220 mm; otherwise the occupant/patient may accidentally fall out of bed. Please note that the height of the mattress has a direct influence on this.

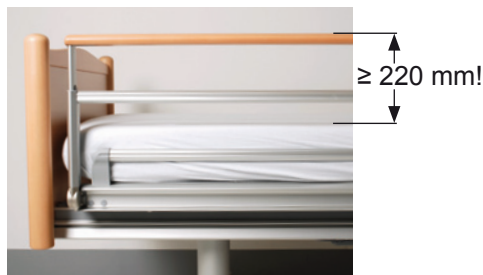

### Use of securing systems

Securing systems such as belts or straps should only be used exactly as specified by the manufacturer.

If securing systems in the form of abdominal belts are used, then it must be ensured that the side rails are completely raised. In this case, the gap in the middle of the rails must be closed using a rail spacer.

**⚠ DANGER** When using securing systems and rail spacers, please note the separate instructions for use pertaining to these accessories.

If the patient is restrained with the help of restraint holders, the lying surfaces must **never** be adjusted while the patient is restrained **and** must always be in the lowest position!

The lying surface adjustment functions must be locked when a patient is secured, and the hand control must be kept out of the occupant's/patient's reach!

Restraints may be fastened directly onto beds built after 08/2009.

To do this, fasten the restraints on the corresponding longitudinal section of the lying surface frame. Make sure that the restraint is passed between the mattress holder and the mattress.

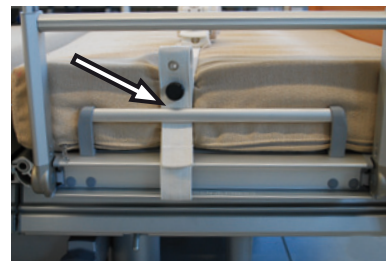









# Activation

The section entitled **Activation** describes the preparation of the bed for use, including the functional check.



## CONTENTS

- General operating instructions  26
- Preparation  27
- Electrical activation  29
- Using the battery pack  30
- Taking out of service  31
- Functional check  32

# Activation | General operating instructions

## On-time

The maximum on-time for the electro-motive bed functions is specified on the bed (type label  72) or in the technical data sheet.

4 min/10 min means that each electro-motive adjustment may be operated for a maximum of 4 minutes followed by a pause of 10 minutes (protection against overheating).

**NOTE** Should the maximum on-time of 4 minutes be exceeded repeatedly or for longer periods, safety cut-out devices on the bed may cause the electromechanical motor system to shut down. The bed must not be manoeuvred using the motors until it has cooled down sufficiently!

## Battery pack

The battery pack integrated into the double drive has a charge capacity that is equivalent in theory to a constant operation of at least 15 lifting and lying surface adjustments with a working load of 250 kg.

**NOTE** If the bed is parked at its location and the mains plug is not connected, this will cause the battery pack to discharge due to the buffering of the electronic components!

Deep-discharged battery packs can be damaged to the extent that premature replacement is needed!

To increase the stand-by time, it is recommended to activate the reset button on the housing when storing the bed and to disconnect the bed from the mains. The bed should not be stored for a period longer than 6 months with a fully charged battery pack without recharging it.

Appropriate and correct use of the battery pack is essential for it to have a long service life!

In order to guarantee electrical functionality at all times, the bed should be connected to the mains as much as possible.

## Safety cut-out device

The bed is equipped with an electrical, self-resetting safety cut-out device that prevents overloading of the motor systems. In the event of very severe overloading, the bed is automatically switched off.

# Activation | Preparation 1/2

## Conditions for set-up

The bed is only approved for use in dry rooms (technical data sheet). A mains power supply and possibly an earth connection are required for operation of the bed in any suitable room. When this is available and the building installation permits it, the bed should always be connected to the potential equalisation.

## Mechanical activation

The supplied head and foot sections must be slotted into the corner connectors on the bed frame (only for model 3082 K Vis-a-Vis).

Check that the cross end stop can be moved freely and has not become jammed during transport.

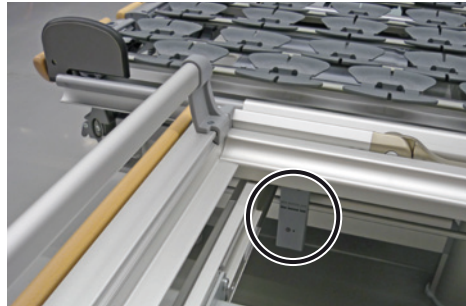

*Cross end stop between upper and lower leg section*

## Hand control connection

The hand control should be connected to the socket provided, where appropriate. The spiral cable must be routed so that it is not under tension.

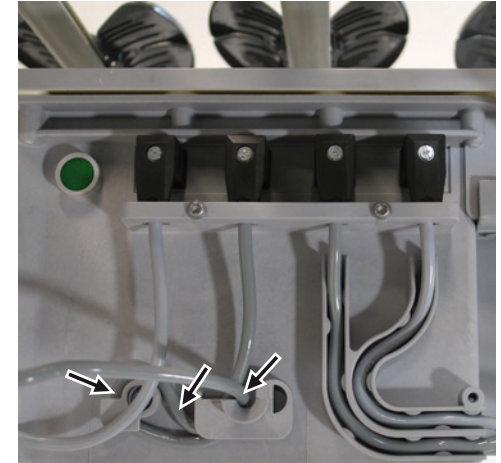

*Routing the hand control cable*

## Activation | Preparation 2/2

### Bed transport

The bed can be moved without auxiliary transportation devices. To do this, set the bed to transport mode (Move lying surface into lowest possible position and lower the castors  35).



**CAUTION** The bed is not designed for transporting people. If a patient is lying in the bed, it must only be pushed within the room. The bed should only be moved on a solid floor. Never attempt to push it over obstacles of over 1 cm in height. The maximum angle of inclination of the floor must not exceed 10°.

The bed can be transported by one person on even surfaces. If the bed has to be moved over falling or rising surfaces, the bed may only be transported by at least two persons holding the bed at the head and foot end, owing to the free moving castors and for the safety of the nursing staff.

## Activation | Electrical activation

**⚠ WARNING** Check the mains cable for damage. If the cable is damaged, the bed must not be used and must be taken out of service immediately!

**NOTE** Please be aware that incorrect handling of the mains isolation switch can lead to the battery pack no longer charging. Incorrect handling can include dropping the mains isolation switch, pulling the mains plug cable to release it from the socket, clamping the mains plug cable between the lying surface and lying surface frame and driving over the cable when transporting the bed.

1. Connect the mains plug to the mains power socket.
2. Press the green button on the mains isolation switch for one second to isolate the mains connection.

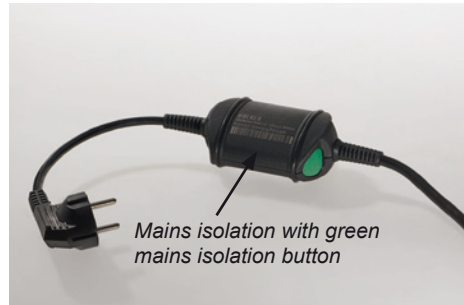

3. Unlock the locking switch on the reverse of the hand control using the key (open lock visible) in order to activate the bed's electrical functions.

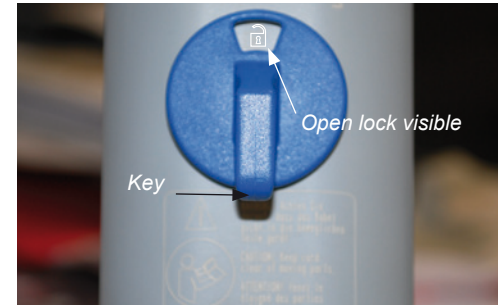

**NOTE** The mains isolation switch ensures that when no electrical function is being actuated, there is no mains voltage to the bed. Exception: while the battery pack is being charged and the nurse hand control is activated.

## Activation | Using the battery pack 1/2

The battery pack allows the bed to be operated independently of the mains supply for at least 15 adjustment cycles under full load.

It is possible to assess the battery status by connecting an additional hand control with LEDs.

The LEDs of the battery display on the additional nurse hand control display three colours:

<b>Green</b>	The battery pack is more than 80% charged.
<b>Yellow</b>	The battery pack is 30-80% charged.
<b>Red</b>	DANGER ZONE. Battery pack is discharged.
<b>Flashing</b>	The battery pack is being charged.

If the LED is red or yellow, the battery pack needs to be recharged. The battery pack is switched off shortly before deep discharging. After the bed is connected to the mains supply, press any button on the hand control to render it

fully functional again. The battery pack is charged when it is connected to the mains after every use or if the charge has fallen too low.

**NOTE** If the bed is stored for a long period without being connected to the mains supply, the battery pack can discharge. The degree of discharge depends on environmental conditions.

To increase the stand-by time, it is recommended to activate the reset button on the housing when storing the bed and to disconnect the bed from the mains. The bed should not be stored for a period longer than 6 months with a fully charged battery pack without recharging it.

The LED displays the battery pack's



charging status during the charging cycle. The current cut-off is deactivated and current flows to the bed when the LED of the mains

voltage display  is green and the LED of the battery display



flashes.

**NOTE** If the red LED lights up but the bed cannot be electrically adjusted, press the mains isolation switch.



**WARNING** If electromagnetic interference occurs with other equipment in the area around the bed, please refrain from using these devices.

The bed should always be handled carefully during transport and protected from damp.

## Activation | Using the battery pack 2/2 and taking out of service

**NOTE** The bed is designed for use in an ambient temperature range from 10 °C to 40 °C, with a relative humidity of 30% to 75% and an air pressure of 700 to 1060 hPa.

**WARNING** The battery pack must only be replaced by personnel trained by Völker GmbH.

**WARNING** If the battery pack is faulty, degassing can occur. In rare cases, this can cause deformation of the battery pack housing. If this occurs, the bed must be immediately taken out of service and taken to an adequately ventilated room without sparks (from electricity or fire). Immediately inform customer services should this occur!

**WARNING** The battery pack must be disposed of in an environmentally responsible manner using the appropriate services. Alternatively, you can return it to Völker GmbH for disposal.

To activate the hand control and the nurse hand control once the bed has been switched on, the hand control and nurse hand control  34 must be unlocked.

### Taking out of service

If the bed is to be out of service for a period longer than two weeks, then the reset button on the engine housing must also be pressed to disconnect the battery pack from the mains.

The mains plug must also be pulled out and the reset button pressed before repair work.

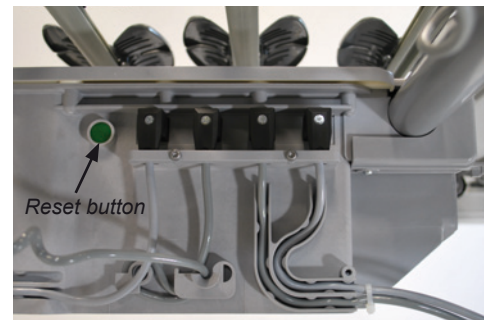

# Activation | Functional check

## Visual inspection

Before each new occupancy of the bed, the following checks must be carried out:

1. Ensure the bed exhibits no visible signs of damage.
2. Ensure that the insulation of the electrical cables is intact.
3. Ensure that the next testing date has not been missed (see testing label).



**WARNING** Only undamaged beds that are still within their testing interval periods may be used!

## Functional check

A functional check must be carried out before each new occupancy:

1. All electrical functions must be actuated to their terminal positions once.
2. The function of all side rails must be checked.
3. The braking function of the bed must be checked.

Once a fault-free functional check has been carried out, the bed is ready for use.















# Operation

The **Operation** section provides you with all the information required to operate the Völker bed.



## CONTENTS

- Key lock  34
- Castors  35
- Side rails  36
  - General safety notes  36
  - Side rails  37
- Back section  39
- Mechanical rapid lowering of the back section / CPR function (option)  40
- Upper and lower leg sections  41
- Lying surface height  42
- Anti-Trendelenburg and Trendelenburg positioning  43
- Comfort seating position  44
- Vis-a-Vis position  45

## Operation | Key lock

Activating the key lock disables all functions of the relevant hand control.

The locking switches are located on the reverse of the hand control and the nurse hand control. They are unlocked (open lock visible) and locked with the key.

If the bed functions cannot be actuated, check whether the key lock is activated.

The key should be removed from the bed when it is not required.



Hand control and/or nurse hand control locked



Hand control and/or nurse hand control unlocked

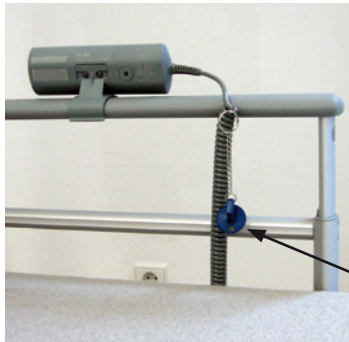

Key

## Operation | Castors

To move the bed, the castors integrated into the four feet of the bed must be lowered. The lying surface must be in its lowest position before this can be done.





### CAUTION "Risk of accident"

If the bed is not being transported, the castors must always be raised, since the bed may be required as a support for when the occupant/patient stands up or lies down. If the bed rolls away while the castors are down, this can lead to a serious fall. Once the castors have been raised, it must be checked that the bed is actually securely parked, i.e. the castors are completely raised.

**NOTE** The bed is not suitable for transporting the occupant/patient.

### Lowering the castors

1. Move the lying surface to its lowest position by pressing the  button.
2. Press the  button while holding the  button down until the lifting device automatically switches off.

The bed is now standing on its four castors and can thus be moved easily.



### Raising the castors

1. Press the   button on the height adjustment control.

The castors retract into the pillars of the lower frame so that the bed stands firmly on four floor protection caps.





**WARNING** All people whose duties involve manoeuvring of the side rails must have read and understood the following information:

- During actuation of the back, upper leg or lower leg section adjustment, of the lift or of the side rails, it must always be ensured that the occupant/patient is not touching the side rails, and that no part of his/her body is sticking out through the side rails.
- If the side rails are used for an individual whose psychological condition necessitates their use, it must be ensured that the hand control is stored completely out of his/her reach or its functions are completely locked. In all cases, care must be taken to ensure that entrapment risks are minimized.
- Protective covers (cot side pads) are available as an accessory for the side rails. These provide additional protection against injury from contact with the side rails. The use of these protective covers is recommended for all persons for whom the risk of injury from unavoidable contact with the side rails is very high. Even with the covers, the care staff or occupant/patient must still take the necessary care when operating the bed.
- If the side rails are used, they must always be either completely raised and securely engaged, or completely lowered to the end stop. Because of the risk of entrapment, they must **never** be left in a position where they are not completely engaged.
- If the side rails are damaged, there is a risk that the patient will fall out of bed.

## Operation | Side rails 1/2

### Raising the side rails

1. Pull the side rail element out horizontally until the end stop, and fold it upwards.
2. To adjust the height of the side rail, pull the telescopic section upwards until it reaches its end stop.

### Lowering the side rails

1. Press both buttons on the outside of the frame, right under the cross-member, to bring the height-adjustable side rail element to its lowest position.



2. Press the trigger labelled "Drücken / Press" at the lower edge of the side rail element and tilt it sideways into the horizontal plane, so that it lies parallel to the floor.

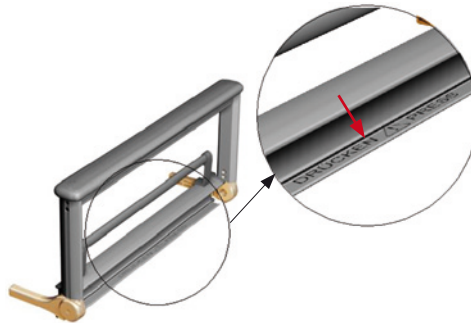

3. Push the rail element completely underneath the lying surface.

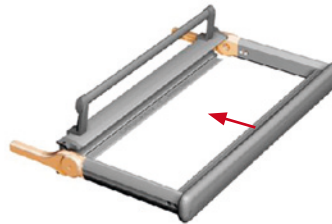

The side rail elements can be used individually or together as required to protect the occupant/patient.

Raising all four rail elements offers the occupant/patient maximum protection.

**WARNING** The side rails should always be gripped with two hands at the ends of the element in question and guided upwards or downwards.

**CAUTION** Any weight on side rail elements that are pulled out horizontally must not exceed 15 kg!

## Operation | Side rails 2/2

**NOTE** Due to their exceptional stability, the side rail elements can also be used as a surface for storing bed linen (max. 15 kg) or as an additional supporting surface for care-related positions, such as Bobath treatments, or for the delivery of physiotherapy-related treatments.

## Operation | Back section

The back lying surface can be adjusted using the hand control or the nurse hand control.

If necessary, disable the hand control lock  34.

The back section of the lying surface can be raised up to an angle of max. 70°.

 **WARNING** When the back section is being raised with the side rails up, it must be ensured that none of the occupant's/patient's or any other person's body parts are sticking out through the side rails or are on top of them!

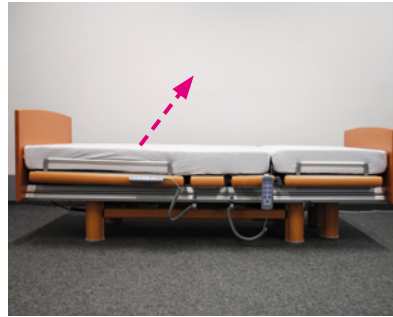

Back section up/down

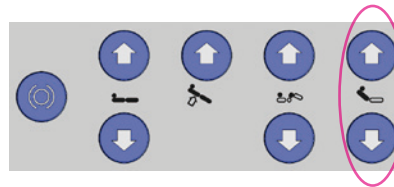

Hand control

Back section up/down

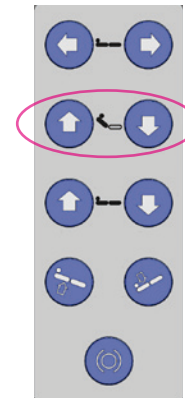

Nurse hand control

 **WARNING "Risk of entrapment"** When adjusting the position of the back section, do not touch the frame in the area of the back section!



## Operation | Mechanical rapid lowering of the back section / CPR function (option)

The bed can optionally be fitted with a mechanical rapid lowering function of the back section for resuscitation.

**⚠ WARNING** The CPR function (Cardiopulmonary Resuscitation function) may only be operated by qualified personnel!

Hold the back section on the mattress holder and pull the red lever located at the left or right underneath the back section of the lying surface upwards to lower the back section rapidly. The back section can now be moved quickly downwards. The lowering process can be interrupted by letting go of the red lever.

**⚠ WARNING** The back section must always be held on the mattress holder so that the back section is not lowered suddenly with the occupant/patient!

Red lever for mechanical rapid lowering of the back section for resuscitation:

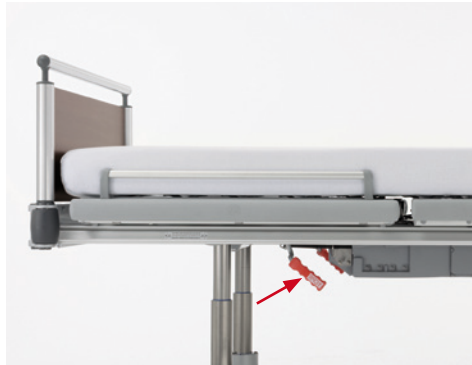



## Operation | Upper and lower leg sections

The position of the upper leg lying surface can be adjusted using the hand control.

If necessary, disable the hand control lock  34.

The upper leg section of the lying surface can be raised up to an angle of max. 45°.

The lower leg section can be moved manually to any position of maximum 16° by pulling on the mattress holder.

To lower the lower leg section, the mattress holder is pulled and the section lifted to the end stop and then lowered. The locking mechanism is disengaged automatically.

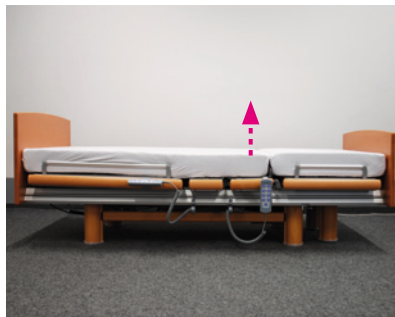

Upper leg section up/down

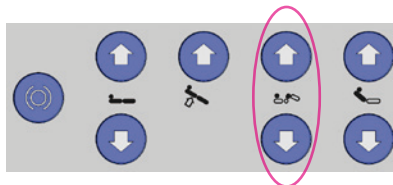

Hand control

 **WARNING** When the upper or lower leg section is being raised with the side rails up, it must be ensured that none of the occupant's/patient's or any other person's body parts are sticking out through the side rails or are on top of them!

 **WARNING "Risk of entrapment"** When the position of the upper leg section is being adjusted, there is a risk of entrapment between the raised side rail and the foot section.

## Operation | Lying surface height

The position of the entire lying surface can be adjusted using the hand control or the nurse hand control.

If necessary, disable the hand control lock  34.

The lying surface height can be adjusted from 40 cm to 71 cm.

 **WARNING** To avoid dangers to the occupant/patient from falling, we recommend that the bed be lowered all the way except when delivering care!

 **DANGER** Before lowering the bed, it must be ensured that no people, limbs, pets, bed linen or other objects are trapped between the lying surface and the lower frame or floor. The bed's position must be stable (castors raised) when the patient is getting in and out of the bed!

 **WARNING** When the height adjustment mechanism is actuated with the side rails up, it must be ensured that the occupant/patient does not have any contact with the side rails, or that any parts of either the patient's body or of other persons are sticking through the side rails!

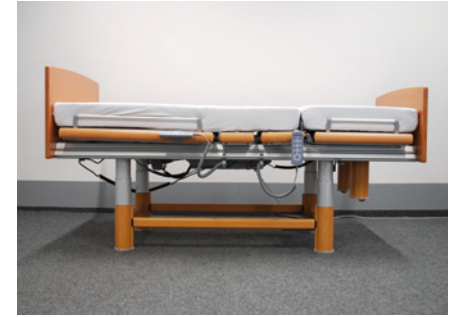
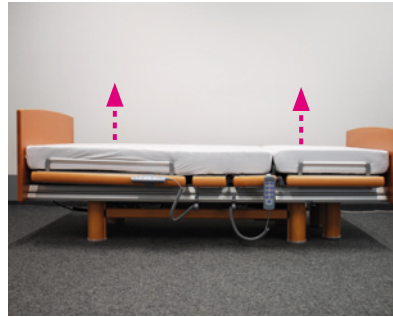

Lying surface up/down

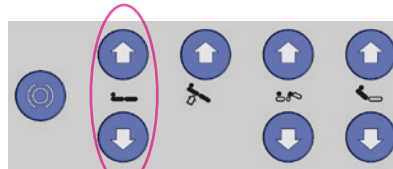

Hand control

Lying surface up/down

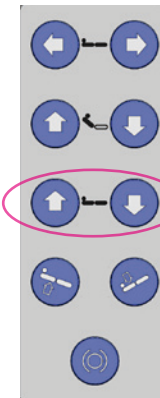

Nurse hand control

## Operation | Anti-Trendelenburg<sup>1</sup> and Trendelenburg positioning<sup>2</sup>

Trendelenburg positioning can only be set using the nurse hand control.

If necessary, disable the hand control lock  34.

The Trendelenburg position can be adjusted up to an angle of 12°.

 **CAUTION** If a fault occurs with the lifting function, or the mains power supply fails and the battery pack is completely discharged, the Trendelenburg function cannot be engaged. The occupant/patient may have to be placed in a different bed!

 **WARNING** Since the Trendelenburg positioning depends on clinical indications, it must only be used with appropriate clinical approval.

The lying surface is automatically returned to its horizontal position if it is moved to its highest or lowest position.



Anti-Trendelenburg positioning<sup>1</sup>

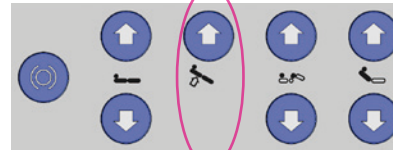

Hand control

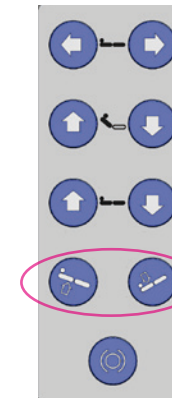

Nurse hand control

Anti-Trendelenburg positioning<sup>1</sup>

Trendelenburg positioning<sup>2</sup>

<sup>1</sup> Head end raised

<sup>2</sup> Head end lowered

## Operation | Comfort seating position



Occupants/patients who are unable to leave the bed either because their circulatory system is too unstable or they first have to be "taught" how to sit can gain a lot of benefit from the comfort seating position as it provides an active sitting position in the bed.



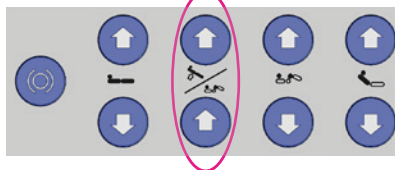





Anti-Trendelenburg positioning







Auto-Contour

Hand control with Anti-Trendelenburg positioning and Auto-Contour (option)

### Adjusting the comfort seating position

1. Move the back    
and the upper leg section    
upwards a little to a comfortable position.  
Alternatively, you can reach this position in a single step by pressing the Auto-Contour button (option)  .
2. Swivel the bed to the comfort seating position by pressing the Anti-Trendelenburg button  .

### Restoring the straight lying surface

To return to a horizontal lying position, move the lying surface  and the back   and upper leg section   in any preferred order to their lowest position.

## Operation | Vis-a-Vis position 1/3

The Vis-a-Vis position can only be set using the nurse hand control plus a few hand movements.

If necessary, disable the hand control lock

 34.

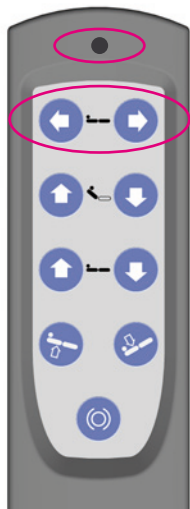

LED

Length extension back

Length extension out

*Nurse hand control*

**NOTE** There is no potential equalization for the lower leg section in the Vis-a-Vis position.



Vis-a-Vis position as a sitting position

The back section is raised up to 70° and the upper leg section up to 7°.

**NOTE** The height adjustment of the bed is 40-71 cm owing to the special function of the bed in the Vis-a-Vis position, since otherwise, small people would not be able to use the Vis-a-Vis bed to support their mobilization.



Vis-a-Vis position for getting up

The back section is raised up to 70° and the lifting mechanism at the head end tilted up to 7°.

**CAUTION** Generally, the foot section of the 3082 K Vis-a-Vis may not be removed. It may only be removed to carry out care-related activities such as changing dressings or the like.

**CAUTION** A maximum load of 80 kg on the lower leg section is permissible when the bed is in the fully extended Vis-a-Vis position!

# Operation | Vis-a-Vis position 2/3

## Setting the Vis-a-Vis position

1. Put up the side rails of the back section.
2. Press the button "Length extension out"  on the nurse hand control. The lying surface now moves to its lowest position (the back section maintains its position). Then the entire lying surface moves in the direction of the foot section.
3. Unlock the Vis-a-Vis locking mechanism on one side of the bed manually and then push it away to the other side.

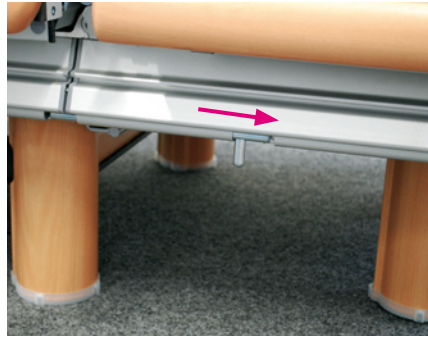

**NOTE** In the Vis-a-Vis position, the following positions of the lying surfaces can also be executed in combination:

Back section:	0-70°
Lifting mechanism, head end:	0-7°
Upper leg section:	0-7°
Height adjustment:	locked
Trendelenburg positioning:	locked



**NOTE** It is only possible to extend the length with the locking mechanism closed!

## Cancelling the Vis-a-Vis position

1. If the bed is in the Anti-Trendelenburg position, first bring it to a horizontal position by pressing the "Lying surface down"  button.
2. Push the lower leg section manually back to the end stop and lock it.
3. Move the lying surface to its end point with the button "Length extension back" .









**DANGER** Be aware that when the "Length extension out" button is actuated, the entire bed moves 25 cm to the foot end, and when the "Length extension back" button is actuated, it moves 25 cm to the head end. These areas must always be kept clear.

## Operation | Vis-a-Vis position 3/3

The nurse hand control has an integrated LED that can assist you when extending the bed lengthwise.



Furthermore, the light emitting diode distinguishes between three different simulations:

The **LED flashes** when a length extension button is pressed    **green**, while the bed is extending in length.

The **LED lights up** when a length extension button is pressed    **green**, if the length extension of the bed has finished and the bed is now in the Normal or Vis-a-Vis initial position.

If the **LED lights up red**, this signals a fault. Please refer to the fault table  61.

**NOTE** If the lying surface of the bed is in a raised position and you press the "Length extension out" button“

 , the lying surface will first move downwards.

Before the length extension begins, however, the lying surface rises again by about 5 cm and lowers again afterwards. The measuring movement is required technically and serves for precisely calibrating the height of the length extension.

# Cleaning and disinfection

This section contains details on the **cleaning and disinfection** of the bed.



## CONTENTS

Cleaning 📖 49

Wipe and spray disinfection 📖 49

Spray lances and automatic washing systems 📖 50



# Cleaning and disinfection 1/2

In order to maintain consistent functioning, the bed should be cleaned, disinfected and tested as soon as possible following each use, so that it can be reused immediately without risk. Incorrect cleaning/disinfection of the bed can cause danger.

## Cleaning

Depending on the degree of soiling, we recommend cleaning the bed with a damp cloth or similar.

## Wipe and spray disinfection

For wipe and spray disinfection, the disinfecting agents featured in the VAH (Verbund für angewandte Hygiene e.V.) list dated 01.03.2011 can be used in their specified concentrations in Germany. They must be applied at the dilution ratio specified by the relevant manufacturer's instructions for use. The list can be obtained under ISBN Number 978-3-88681-106-9.

**NOTE** Solvents are not permitted. Scouring agents, abrasive sponges or other blunting agents must not be used.

Organic solvents such as halogenated / aromatised hydrocarbons and ketones must not be used.

The following instructions must be noted when using cleaning and disinfecting agents:

- The working solutions should generally be freshly prepared.
- The concentrations used should be neither higher nor lower than those given in the list. The so-called "shot" method should not be used under any circumstances. Under no circumstances should someone using a disinfectant follow their own judgement to add a detergent such as a soap or detergent substance (leads to soap failure).

- There is a risk of fire or explosion from alcoholic spray disinfectants when these are used over large areas.
- They must not contain any corrosive or irritant components.
- They must not contain any substances that change the surface structure or gripping properties of the materials.
- Lubricants must not be affected.
- The pH value of the water must be no higher or lower than 6-8.
- Water should not exceed a total water hardness of 0.9 mmol/l (up to 5 deg d).

## Cleaning and disinfection 2/2

The specifications in the VAH list, as well as the specifications we have issued do not absolve the user of the obligation to carry out his or her own checks and investigations, since the ratios (e.g. water hardness) can vary depending on the geographical location. It is therefore impossible to offer legally binding assurance of certain properties.

If unsuitable washing and disinfecting agents are used, if the mixing ratio is incorrect or if there is inadequate care of the beds, damage can occur to the surface coating for which Völker GmbH is not liable.



### **WARNING "Risk of electric shock / fire and functional failure"**

The bed must always be disconnected from the power supply during cleaning and disinfection.

The plug and the socket of the hand control are only protected against spray when the control is stowed and the appropriate cover is in place.

### **Spray lances and automatic washing systems**

Cleaning and disinfection using spray lances from high-pressure cleaning equipment and in automatic bed washing systems is **not** permissible.

# Maintenance

The **Maintenance** section contains information on how to carry out maintenance work.

## CONTENTS

Staff training  52

Safety notes  52

Maintenance schedule  54

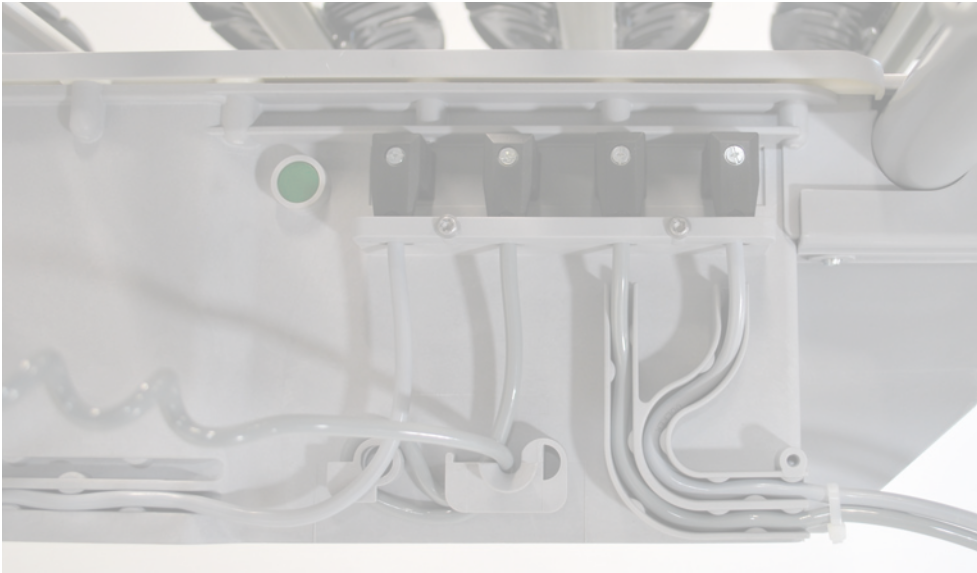

# Maintenance | Staff training, safety notes 1/2

## Staff training

Every person involved with maintenance or servicing must at least

- have taken part in service training by Völker
- have read the safety notes and
- the service manual

and be qualified in accordance with MPBetreibV §§ 4 and 6. To avoid errors and ensure that our beds work properly, these documents must always be accessible to service personnel.

Before commencing maintenance work, the service manual and the instructions for use must be read in full by the person responsible for carrying out the servicing.

## Safety notes

During maintenance and technical checks, the following specifications must be strictly observed:

- The room's electrical installations must satisfy current technical requirements and the bed must be used correctly.
- The castors must be retracted (bed is fixed).
- The beds are not protected against explosion and must therefore only be maintained in an environment free from flammable substances and materials.

 **WARNING** Before carrying out any repair work, always disconnect the mains plug **and** disconnect the battery pack from the mains by pressing the green reset button on the engine housing.

 **WARNING** Maintenance and repair work should only be carried out after the bed has been disinfected.

 **WARNING** Maintenance and repair work should, in principle, only be carried out on an unoccupied bed. The resident/patient may also have to be transferred to another bed before the work.

 **WARNING** After maintenance (repair) work is complete, always check that the bed is functioning correctly. It must be checked that the bed can be used correctly without risk to the occupant/patient or care personnel.

 **WARNING** When working on the open motor, it must be ensured that there is no contact with the power supply board for at least 20 minutes after disconnecting it from the power supply and the battery. The reason for this is to allow self-discharge of the smoothing capacitor, which would represent a risk to persons.

## Maintenance | Safety notes 2/2



**WARNING** When connecting a motor to the extension board, it must be noted that only one motor may be connected.

## Maintenance | Maintenance schedule

The bed requires little maintenance. All movable parts for the height adjustment mechanism, the lying surface motor systems and the side rails are provided with long-lasting lubricant at the factory. It is recommended that **the bed is subjected to a regular, or at least once a year, Technical check** 📖 55 (incl. visual inspection and functional check) as described in the checklist 📖 83 and any damage uncovered as a result, such as signs of wear and tear, loose screws or breaks/fractures, be eliminated immediately.

After every lengthy period of non-use, a Technical check 📖 55 must be carried out.







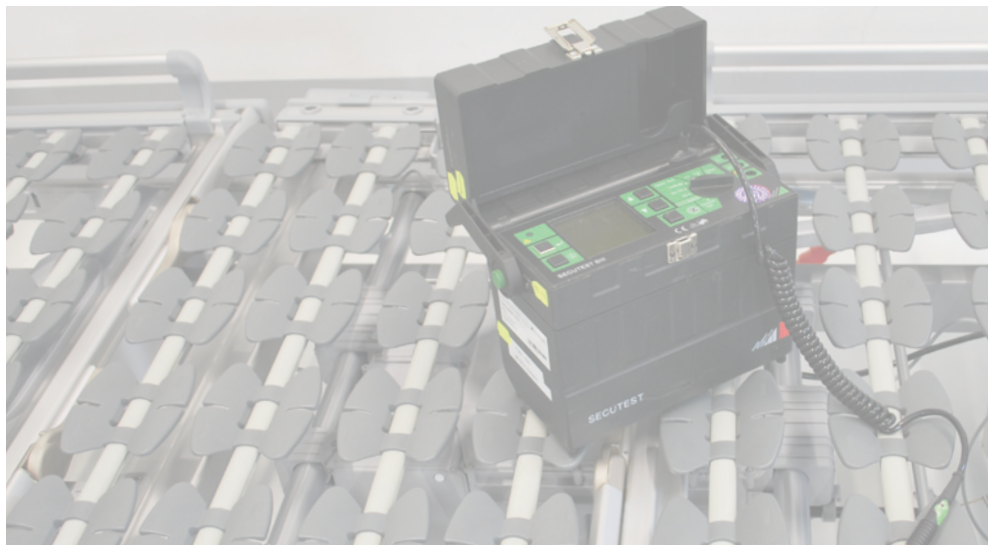



Period	Work to be carried out
Annually and after lengthy periods of non-use	Technical check 📖 55
As required	Lubricate mechanical parts Replace parts subject to wear in cases of defect <ul style="list-style-type: none"><li>• wings (if present)</li><li>• spring elements (if present)</li></ul>
Every 3-5 years	Replace the battery pack

## Technical check

The section entitled **Technical check** contains all the information needed to carry out the technical check in accordance with MPBbetriebV, BGVA3, UVV on hospital and care beds and measurement as per DIN EN 62353. Other (e.g. country-specific) specifications have not been included here. This does not absolve the operator from the obligation to observe any such specifications.



## CONTENTS

- Visual inspection  56
- Functional check of the side rails  56
- Functional check of the brakes  58
- Functional check of the motors  58
- Mains connection cable  58
- Cabling  58
- Housing  58
- Mechanical check  58
- Measuring in accordance with DIN EN 62353  59
- Checking the trapeze bar grab handle  59
- Further accessories  59

# Technical check 1/4

## 1. Visual inspection

Check the frame parts for plastic deformations and/or wear and tear. This includes the lower frame, the lifting mechanism, all parts of the lying surface (back, seat, upper leg and lower leg sections, wing and spring elements (if present)), trapeze bar, trapeze bar holder and castors.

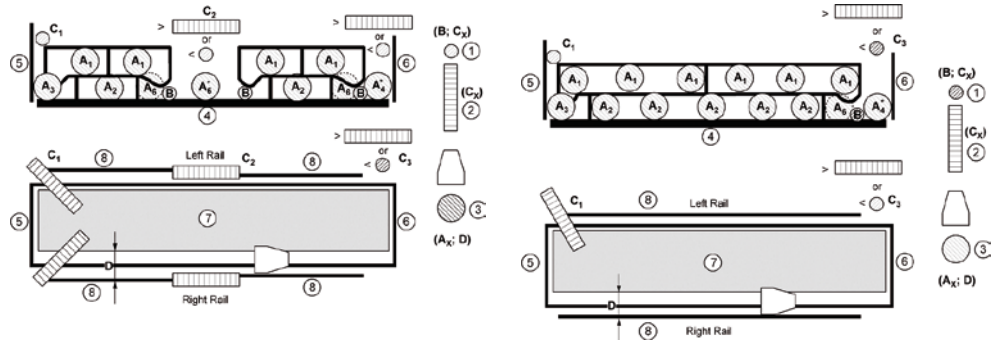

## 2. Functional check of the side rails

The side rails must be checked in accordance with DIN EN 60601-2-52 or DIN EN 60601-2-38. Please see the declaration of conformity supplied with the bed for which of the two standards should be used.

### Inspection in accordance with DIN EN 60601-2-52

Check that the locking mechanism for the side rails is working correctly and that there are no visible deformations or signs of wear and tear on the side rails.

Check that the prescribed distances are maintained, even when the side rails are

Letter	Description	Dimension
A <sub>x</sub>	The distance between elements within the scope of the SIDE RAIL in its raised/engaged position or of the area formed by the SIDE RAILS and the fixed parts of the BED or ACCESSORIES.	< 120 mm
B	Not applicable	-
C <sub>1</sub>	Distance between HEAD SECTION and SIDE RAIL	< 60 mm
C <sub>2,3</sub>	Distance between divided SIDE RAIL and distance between SIDE RAIL and FOOT SECTION	< 60 mm or > 318 mm
D	Area between SIDE RAIL and MATTRESS	120 mm cone may sink max. 60 mm under the mattress surface without pressure
G	Height of the upper edge of the SIDE RAILS over the mattress over at least 1/2 of the length of the LYING SURFACE	≥ 220 mm



## Technical check 2/4

placed under load. All measurements of the side rail distances should be made in the flat lying surface position, since the dimensions given while the bed is otherwise positioned do not show less favourable conditions.

The measurement of A and D must be performed using a cone as defined in DIN EN 60601-2-52. The force used for measurement A must be at least 250 N.

### Inspection in accordance with DIN EN 60601-2-38

Check that the locking mechanism for the side rails is working correctly and that there are no visible deformations or signs of wear and tear on the side rails.

Check that the prescribed distances are maintained, even when the side rails placed under load. All measurements of side rail distances must be carried out in the flat lying surface position.

The measurement of A must be performed using a cone as defined in DIN EN 60601-2-38. The force used for measurement A must be at least 50 N.

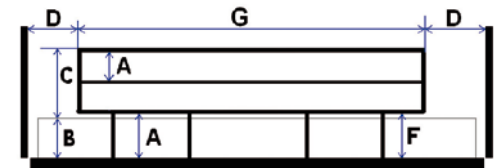
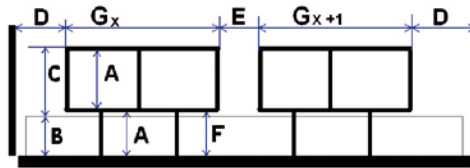

Letter	Description	Dimension
A	The greatest distance between the elements within the scope of the SIDE RAILS in a raised / engaged position or the area formed by the SIDE RAILS and fixed parts of the BED.	≤120 mm
B	Thickness of the mattress for CORRECT USE	defined by the manufacturer
C	Height of the upper edge of the SIDE RAILS over the mattress (see "B") without compression	≥220 mm
D	Distance between the HEAD or FOOT SECTION and the SIDE RAIL	≤60 mm or ≥235 mm
E	Distance between the divided SIDE RAIL with the LYING SURFACE in flat position	≤60 mm or ≥235 mm
F	Distance of all accessible openings between the SIDE RAILS and the LYING SURFACE	if D or E ≥235 mm then F ≤60 mm if D or E ≥60 mm then F ≤120 mm
G	Total length of the SIDE RAIL or sum of the length of the divided SIDE RAILS on one side of the BED	$\sum G_x \geq 1/2$ the length of the LYING SURFACE

## Technical check 3/4

### 3. Functional check of the brakes

Check the function of the brake (safety, castors retracted and free running). Raise and lower the castors.

### 4. Functional check of the motors

Travel through the full adjustment range of each motor. Look out for any unusual noises, watch the speed, ease of running etc., and check that the selected function travels in the correct direction. Particularly ensure that the motor switches off automatically when it reaches its terminal position\*.

\* Please note that the terminal position can vary from bed model to bed model. Please consult the technical specifications for this, or if in doubt, contact our service department.

### 5. Mains connection cable

Check

- the mains connection cable, incl. cable guides,
  - the strain relief, including kink protection sleeve,
  - the mains connection plug
  - the cable hooks
- for damage.

### 6. Cabling

Check the cable guides and that the plug connectors are correctly seated and do not exhibit any damage.

Check the cables for damage.

### 7. Housing

Check all housings for damage. All screws must be firmly tightened and seals must not exhibit any visible damage.

### 8. Mechanical check

Check the function of the supporting disc by manually moving the lower leg section to the individual positions.

## Technical check 4/4

### 9. Measuring in accordance with DIN EN 62353

The bed must be checked electrically in accordance with DIN EN 62353. The leakage current should be measured by means of alternative measurement. The max. measured value must be less than or equal to 500  $\mu$ A.

On beds with a potential equalisation connection (see sketch below), the impedance of the potential equalisation within the bed must also be measured.

The impedance must be no less than  $0,2 \Omega$  ( $I=5\dots 25$  A,  $R=U/I < 0,2 \Omega$ ).

### 10. Trapeze bar grab handle

Check whether the plastic and holding frame of the grab handle exhibit any damage and that the fixing rods on the trapeze bar are intact.

The handle of the trapeze bar, including the fastening strap, must be replaced in the following cycle:

- Every 5 years: handles and handles with roll function in nursing homes
- Every 3 years: handles with roll function in hospitals

### 11. Further accessories

Further accessories must always be checked in accordance with the manufacturer's instructions.

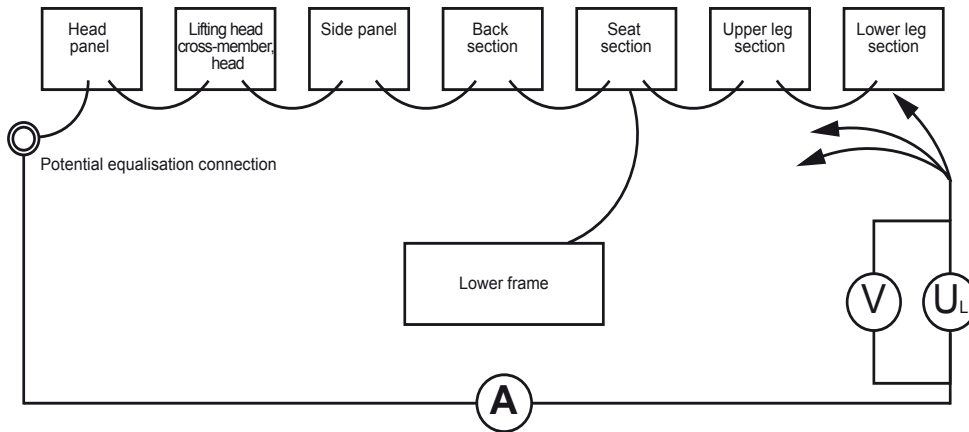

# Troubleshooting

The section entitled **Troubleshooting** contains a table of faults for users, together with information on the service points.

## CONTENTS

Table of faults 📖 61

Service points 📖 66



## Troubleshooting | Table of faults 1/5

The following table contains information on possible functional problems that the users can resolve themselves.

Faults that can only be eliminated by technical engineers are described in the service manual.

Anyone responsible for carrying out maintenance and repair work must at least have taken part in a service training by Völker, have read the safety notes and the service manual and be qualified in accordance with MPBetreibV §§ 4 and 6.

**NOTE** Before carrying out any troubleshooting, check that the bed is connected to the power supply (the mains plug is in a live socket).



**WARNING** Before carrying out any repair work, ensure that the bed has been disconnected from the power supply and from the battery pack by pressing the reset button.

If the same fault occurs repeatedly, use the Völker Diagnostic System (VDS) to read out the error memory before resetting the system again.

**NOTE** Ensure the correct configuration of the extension board's plug contacts at the twin drive:









Sensor connection

No function

Connection option for additional hand controls







Length extension motor connection

## Troubleshooting | Table of faults 2/5

Fault	Possible cause	Troubleshooting
Adjustment of the lying surface (back, upper leg and lower leg section) not functioning.	(1) Hand control locked (2) Nurse hand control locked. (3) The mains plug is not plugged in or there is no power to the socket and battery pack is discharged. (4) Bed taken out of service. (5) Communication error in the electronics. (6) The hand control is faulty. (7) The nurse hand control is faulty.	(1) Unlock hand control  34. (2) Unlock nurse hand control  34. (3) Connect the plug or check the socket. Then press the green button on the mains isolation  29, and then press any hand control function. (4) Press the green button on the mains isolation  29, and then press any hand control function. (5) Press the Reset button  31 on the dual drive. After about 10 seconds press the green button on the mains isolation  29, and then press any main control function. Never press both green buttons at the same time! (6) Replace hand control. (7) Replace nurse hand control.

 Continued on next page.

## Troubleshooting | Table of faults 3/5

Fault	Possible cause	Troubleshooting
The bed cannot be adjusted in height.	<ol style="list-style-type: none"> <li>(1) Hand control locked</li> <li>(2) Nurse hand control locked.</li> <li>(3) The mains plug is not plugged in or there is no power to the socket and battery pack is discharged.</li> <li>(4) Bed taken out of service.</li> <li>(5) Communication error in the electronics.</li> <li>(6) Lying surface is not retracted to the end point on the head side.</li> </ol>	<ol style="list-style-type: none"> <li>(1) Unlock hand control  34.</li> <li>(2) Unlock nurse hand control  34.</li> <li>(3) Connect the plug or check the socket. Then press the green button on the mains isolation  29, and then press any hand control function.</li> <li>(4) Press the green button on the mains isolation  29, and then press any hand control function.</li> <li>(5) Press the green Reset button  31 on the dual drive. After about 10 seconds press the green button on the mains isolation  29, and then press any main control function. Never press both green buttons at the same time!</li> <li>(6) Press the button "Length extension out" on the nurse hand control until the lying surface has retracted to its end point and the LED on the nurse hand control lights up green.</li> </ol>

 *Continued on next page.*

## Troubleshooting | Table of faults 4/5

Fault	Possible cause	Troubleshooting
The bed cannot be adjusted in height.	(1) The hand control is faulty. (2) The nurse hand control is faulty.	(1) Replace hand control. (2) Replace nurse hand control.

### Possible faults during Vis-a-Vis operation:

It is difficult to lock or unlock the bar between the upper and lower leg sections.	(1) The lower leg section and the rest of the bed are not exactly aligned and the sides of the bed are therefore out of line.	(1) Make sure that the sides of the bed are aligned and that the side plates between the lower leg section and the rest of the bed are exactly in line.
Although it may unlock, the lower leg section cannot be moved.	(1) Lying surface is not extended to the end point on the foot side.	(1) Close Vis-a-Vis locking mechanism again and press the button "Length extension back" on the nurse hand control until the lying surface is extended to its end point in the direction of the foot side and the LED on the nurse hand control lights up green.
Lower leg section cannot be moved smoothly.	(1) Uneven surface in the direction of movement.	(1) Position the bed so that the floor under the lower leg section is smooth and flat (free of hollows or bumps).

 *Continued on next page.*



## Troubleshooting | Table of faults 5/5

Fault	Possible cause	Troubleshooting
The bed cannot be extended lengthwise to the head section.	(1) Vis-a-Vis locking mechanism is not closed or only closed on one side. (2) Comfort position (Anti-Trendelenburg) has not completely gone down.	(1) Push Vis-a-Vis locking mechanism in the direction of the head section on both sides of the bed to lock. (2) Press the "Lying surface down" button on the hand control until the lying surface is completely horizontal in its lowest position.
The bed cannot be extended lengthwise to the foot section.	(1) Vis-a-Vis locking mechanism is not closed or only closed on one side.	(1) Close Vis-a-Vis locking mechanism on both sides of the bed.
Error message, that is displayed by LED lighting up red on the nurse hand control.	(1) Vis-a-Vis locking mechanism is not closed or only closed on one side. (2) The required function requires the bed to be fully moved into the Vis-a-Vis initial position or the Normal position.	(1) Close Vis-a-Vis locking mechanism on both sides of the bed. (2) Press the button "Length extension out" or "Length extension out" on the nurse hand control until the lying surface has moved to the corresponding end point and the LED on the nurse hand control lights up green.

## Troubleshooting | Service points

If necessary, please seek assistance from the relevant contact at your nearest Völker sales organisation. You will receive all the information you need for comprehensive service promptly.

# Appendix

The **Appendix** section contains the technical specifications and classifications, details on the service life and disposal of the equipment and links to the manufacturer's declarations and forms found in the appendix.

## CONTENTS

Symbols used  68

Technical data  69

Classification  71

Type label  72

Service life/disposal  74

Manufacturer's declarations, forms, electronic instructions for use  75

Konformitätserklärung  
Anhang VII  
EU-Richtlinie 93/42/EWG

Declaration of conformity  
Appendix VII  
EU Directive 93/42/EEC

Déclaration de conformité  
Annexe VII  
Directive EU 93/42/CEE

Der Unterzeichnende  
Völker GmbH  
Wullener Feld 79  
58454 Witten

The signatory  
Völker GmbH  
Wullener Feld 79  
58454 Witten/Germany

La soussignée  
Völker GmbH  
Wullener Feld 79  
58454 Witten/Allemagne

mit einer Fertigungsstätte unter der Adresse:  
Völker GmbH  
Ahornstraße 4  
09661 Hainichen

with a manufacturing site at:  
Völker GmbH  
Ahornstraße 4  
09661 Hainichen/Germany

avec un site de production à:  
Völker GmbH  
Ahornstraße 4  
09661 Hainichen/Allemagne

bestätigt, dass die nachfolgend bezeichneten  
Produkte in der von uns in Verkehr  
gebrachten Ausführung die grundlegenden  
Anforderungen des Anhangs I der EU-  
Richtlinie 93/42/EWG erfüllen. Es wurden die  
folgenden Normen angewendet:

DIN EN 60601-1:2007-07,  
DIN EN 60601-1-2:2007-12,  
DIN EN 60601-1-4:1996+A1:1999,

confirms that the products described  
below and in the form distributed by  
ourselves meet the basic requirements of  
Appendix I of EU Directive 93/42/EEC.  
The following standards are applied:

DIN EN 60601-1:2007-07,  
DIN EN 60601-1-2:2007-12,  
DIN EN 60601-1-4:1996+A1:1999,  
DIN EN 60601-2-52:2010-12.

confirme que les produits spécifiés ci-  
dessous sont conformes, dans le modèle  
mis en circulation, aux exigences  
fondamentales de L'annexe L de la  
directive européenne 93/42/CEE.  
Les standards suivants sont appliqués:

DIN EN 60601-1:2007-07,  
DIN EN 60601-1-2:2007-12,  
DIN EN 60601-1-4:1996+A1:1999,  
DIN EN 60601-1-4:1996+A1:1999,

## Appendix | Symbols used



### Warning symbols

Information marked with this symbol must always be read and strictly observed!



Warning about the risk of crushing and entrapment!



Note the information in the instructions for use!



= 250 kg

Safe working load 250 kg



= 215 kg

Max. permitted weight of the occupant/patient  
215 kg (in application environments 3, 4 and 5)  
9



Direct current



Alternating current



Protection class II device, protection-insulated



Type B application part as per DIN EN 60601-1



The product satisfies the fundamental requirements of Appendix 1 of EU Directive 93/42/EEC.



The product must be disposed of in accordance with EU Directive 2002/96/EC pertaining to old electrical and electronic equipment.

## Appendix | Technical data (standard design) 1/2

The details marked below with \* are dependent on the length, width or model of the bed. The values specified relate to model 3082 Vis-a-Vis in design S.



External dimensions (W x L) for lying surface 90 x 200 cm *	approx. 98 x 211 cm
for lying surface 90 x 210 cm *	approx. 98 x 221 cm
for lying surface 90 x 220 cm *	approx. 98 x 231 cm
for lying surface 100 x 200 cm *	approx. 108 x 211 cm
for lying surface 100 x 210 cm *	approx. 108 x 221 cm
for lying surface 100 x 220 cm *	approx. 108 x 231 cm
Clearance height	approx. 13,5 cm
Height of the lower edge of lying surface frame (min./max.)*	approx. 25.5 cm / 55.5 cm
Height of the upper edge of the lying surface (min./max.)*	approx. 40 cm / 71 cm
Height of upper edge of head and foot section (min./max.)*	approx. 76.5 cm / 106,5 cm
Lying surface (4-part) *	approx. 90 x 200/210/220 cm approx. 100 x 200/210/220 cm
Volumetric weight of the mattress material	40 - 50 kg/m <sup>3</sup>
Unladen weight *	approx. 147 kg

Safe working load for the bed	250 kg	
Max. occupant/patient weight  9	<u>in application environment 1.2</u>	<u>in application environment 3, 4, 5</u>
3082 Vis-a-Vis	185 kg	215 kg
3082 K Vis-a-Vis	185 kg	215 kg
Safe working load for the trapeze bar holder	75 kg	
Safe working load for drip stands	2 kg / hook	
Castors	6 pcs., Type: K-100/2x1, Halver castors or Blickle castors	
Max. castor load	100 kg (dynamic)	

## Appendix | Technical data (standard design) 2/2

Mains voltage	AC 230 V (EU version) AC 240 V (UK version) AC 115 V (US version)
Rated power	300 VA
Rated frequency	50 Hz (EU-, UK version) 60 Hz (US version)
Primary fuse	3.15 A (EU version) 5.0 A (UK version) 6.3 A (US version)
Battery pack	Type: 2 x 12 V block battery (lead gel) 7.2 Ah
Operating temperature range	+ 10 °C to + 40 °C
Transport / storage temperature range	- 20 °C to + 60 °C
Air humidity	30 % to 75 % rel.
Atmosphere range	700 hPa to 1060 hPa
Operating volume	55 db(A)

## Appendix | Classification

Protection against electric shock	Protection class II or device with internal electrical current source 
Protection type by housing as per EN 60529	IPX4 not suitable for cleaning in automatic washing systems
Degree of protection of the applied part against electric shock as per DIN EN 60601-1	Type B 
Degree of protection against explosive substances and mixtures	The bed is not protected against explosion and should not be used in an environment in which flammable anaesthetics or flammable cleaning agents are present (see brochure from accident prevention organisation ZH 1/200)
Grouping/Classification as per 93/42/EEC Appendix IX	Class I

Mode of operation	Int. 4 min. / 10 min. On time max. 4 min. Off time 10 min.
Technical check	1x yearly

# Appendix | Type label 1/2

## Type specifications

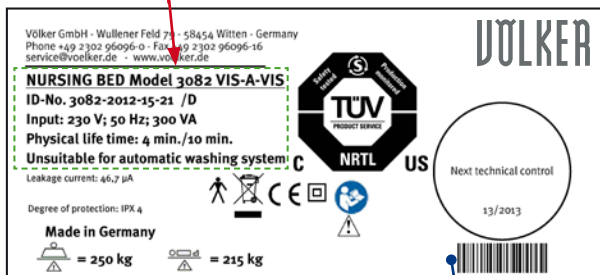

The type label is located on the inside of the head panel.

Raise the back section to read the type label.



Type specifications	Declaration
1st line	Model designation. In the example: NURSING BED Model 3082 VIS-A-VIS
2nd line	ID-No. (made up as follows): 3082 = Model -2012 = Year of construction -15 = Production week (calendar week) -21 = Consecutive number D = Mains plug version (e.g. D = Germany)
3rd line	Input: mains voltage; mains frequency; consumed power
4th line	Physical life time: max. uninterrupted on-time of electric motor adjustment. In the example: 4 min./10 min. This means that the bed may be operated with the electric motor without interruption for max. 4 minutes, after which a pause of 10 minutes will be necessary (protection against overheating).
5th line	Suitability for automatic washing systems. In the example: unsuitable for automatic washing system.

Symbols used 68



## Appendix | Type label 2/2

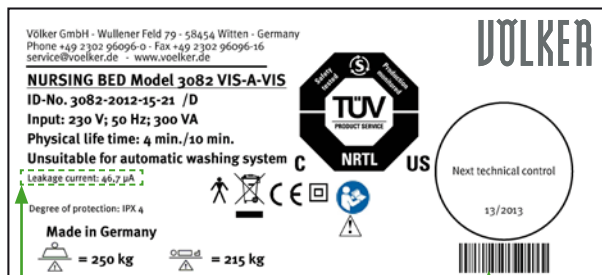

Measured values

Barcode

### Measured values

1st line      Leakage current in µA

The specified initial measured values were measured in accordance with EN 62353.





The barcode (code 39) contains the numeric ID No. (10 digits).

## Appendix | Service life / disposal



The bed's expected service life is approx. 10 years. To ensure environmentally responsible disposal after decommissioning, please contact your responsible area sales manager.

# Appendix | Manufacturer's declarations, forms, electronic instructions for use

## Manufacturer's declarations

- Declaration of conformity  76
- Table 201 – Guidelines and manufacturer's declaration – Electromagnetic compatibility (6.8.3.201 a) 3))  77
- Guidelines and manufacturer's declaration – Electromagnetic compatibility (6.8.3.201 a) 6))  78
- Table 204 – Guidelines and manufacturer's declaration – Electromagnetic compatibility for all devices and systems that are not life-sustaining (6.8.3.201 b))  80
- Table 206 - Recommended protected distance between portable and mobile HF telecommunications equipment and the bed – for devices and systems that are not life-sustaining (6.8.3.201 b))  82

## Forms

- Technical check of Völker hospital and healthcare beds in accordance to German standards and safety regulations incl. measurements required  83
- Spare part order form  84

## Electronic instructions for use

- Requirement for the use of the electronic instructions for use  85

Konformitätserklärung / Declaration of Conformity / Déclaration de conformité

<p>Konformitätserklärung Anhang VII EU-Richtlinie 93/42/EWG</p>	<p>Declaration of conformity Appendix VII EU Directive 93/42/EEC</p>	<p>Déclaration de conformité Annexe VII Directive EU 93/42/CEE</p>
<p>Der Unterzeichnende Völker GmbH Wüllener Feld 79 59454 Witten</p>	<p>The signatory Völker GmbH Wüllener Feld 79 59454 Witten/Germany</p>	<p>La soussignée Völker GmbH Wüllener Feld 79 59454 Witten/Allemagne</p>
<p>mit einer Fertigungsstätte unter der Adresse: Völker GmbH Alhornstraße 4 09661 Hainichen</p>	<p>with a manufacturing site at: Völker GmbH Alhornstraße 4 09661 Hainichen/Germany</p>	<p>avec un site de production à: Völker GmbH Alhornstraße 4 09661 Hainichen/Allemagne</p>
<p>bestätigt, dass die nachfolgend bezeichneten Produkte in der von uns in Verkehr gebrachten Ausfertigung die grundlegenden Anforderungen des Anhangs I der EU-Richtlinie 93/42/EWG erfüllen. Es wurden die folgenden Normen angewendet:</p>	<p>confirms that the products described below and in the form distributed by ourselves meet the basic requirements of Appendix I of EU Directive 93/42/EEC. The following standards are applied:</p>	<p>confirme que les produits spécifiés ci-dessous sont conformes, dans le modèle mis en circulation, aux exigences fondamentales de l'annexe I de la directive européenne 93/42/CEE. Les standards suivants sont appliqués :</p>
<p>DIN EN 60601-1:2007-07, DIN EN 60601-1-2:2007-12, DIN EN 60601-1-4:1996+A1:1999, DIN EN 60601-2-52:2010-12.</p>	<p>DIN EN 60601-1:2007-07, DIN EN 60601-1-2:2007-12, DIN EN 60601-1-4:1996+A1:1999, DIN EN 60601-2-52:2010-12.</p>	<p>DIN EN 60601-1:2007-07, DIN EN 60601-1-2:2007-12, DIN EN 60601-1-4:1996+A1:1999, DIN EN 60601-2-52:2010-12.</p>
<p>Damit sind die Anforderungen des Medizinproduktegesetzes zur Anbringung einer CE Kennzeichnung erfüllt.</p>	<p>The requirements of the medical products law pertaining to the display of a CE seal of approval are thereby fulfilled.</p>	<p>Les exigences de la loi sur les produits médicaux concernant l'apposition de la <b>marque CE</b> sont ainsi satisfaites.</p>
<p>Bei einer nicht mit dem Hersteller abgestimmten Änderung des Produktes verliert diese Konformitätserklärung ihre Gültigkeit.</p>	<p>This declaration of conformity becomes invalid if the products are altered without the agreement of the manufacturer.</p>	<p>Cette déclaration de conformité est invalidée en cas de modification des produits, non autorisée par le fabricant.</p>
<p><b>Bezeichnung der Produkte :</b> Pflegebetten 2082, 3082, 3082 K, 3082 Vis-a-Vis, 3082 K Vis-a-Vis, Belletto 3082 Vis-a-Vis, S 282, S 382, S 382 Vis-a-Vis.</p>	<p><b>Description of products /Article No.:</b> Nursing beds 2082, 3082, 3082 K, 3082 Vis-a-Vis, 3082 K Vis-a-Vis, Belletto 3082 Vis-a-Vis, S 282, S 382, S 382 Vis-a-Vis.</p>	<p><b>Désignation des produits</b> <b>Modèle/Référence :</b> Lits médicalisés 2082, 3082, 3082 K, 3082 Vis-a-Vis, 3082 K Vis-a-Vis, Belletto 3082 Vis-a-Vis, S 282, S 382, S 382 Vis-a-Vis.</p>
<p>EG-Richtlinien : Richtlinie 93/42/EWG vom 14.06.1993 über Medizinprodukte (Anhang I, Grundlegende Anforderungen). Die Produkte sind Produkte der Klasse I gemäß Anhang IX der Richtlinie 93/42/EWG vom 05.09.2007.</p>	<p>EU Directives : Directive 93/42/EEC of 14.06.1993 concerning medical products (Appendix I, Basic requirements). The design and construction of this product conforms to Class I (Appendix IX) Directive 93/42/EEC of 05.09.2007.</p>	<p>Directives européennes : Directive 93/42/CEE du 14.06.1993 sur les produits médicaux (annexe I « Exigences fondamentales »). La conception du produit est conforme à la classe I (annexe IX) Directive 93/42/CEE du 05.09.2007.</p>

Witten, 20.02.2012

Mitchell Tidman  
Geschäftsführer / Managing Director / Gérant

**Info**  
You can find a printable version of this document on the Internet at [www.voelker.de](http://www.voelker.de).

**Table 201 - Guidelines and manufacturer's declaration - Electromagnetic compatibility  
(6.8.3.201 a) 3))**

The bed is intended for use in the electromagnetic environment as described below. The customer or user of the bed should ensure that it is used in such an environment.

<b>Emissions measurements</b>	<b>Conformity</b>	<b>Electromagnetic environment - guideline</b>
HF emissions IEC 61000-3-2	Class A	The bed is suitable for use in all institutions, including residential areas and such that are directly connected to a public mains supply network that also supplies buildings intended for residential purposes.
Fluctuations in voltage / flicker IEC 61000-3-3	Conforms	
RF emissions CISPR 14 – 1	Conforms	The bed is not suitable for connection to other equipment.

## Guidelines and manufacturer's declaration - Electromagnetic compatibility (6.8.3.201 a) 6))

The bed is intended for use in the electromagnetic environment as described below. The customer or user of the bed should ensure that it is used in such an environment.

Compatibility check	IEC 60601 Testing level	Conformity level	Electromagnetic environment - guideline
Discharge of static electricity (ESD) IEC 61000-4-2	± 6 kV contact discharge ± 8 kV air discharge	± 6 kV contact discharge ± 8 kV air discharge	The ground should be made of wood or concrete and be laid with ceramic tiles. If the ground is covered with synthetic material, the relative air humidity must be at least 30%.
Rapid transient electrical disturbance / bursts IEC 61000-4-4	± 2 kV for voltage supply ± 1 kV for input and output cables	± 2 kV for voltage supply Not applicable	The quality of the voltage supply should be commensurate with a typical commercial or hospital environment.
Surge voltages IEC 61000-4-5	± 1 kV series mode voltage ± 2 kV common-mode voltage	± 1 kV series mode voltage Not applicable	The quality of the voltage supply should be commensurate with a typical commercial or hospital environment.

 *Continued on next page.*

Compatibility check	IEC 60601 Testing level	Conformity level	Electromagnetic environment - guideline
Voltage drops, short interruptions and voltage fluctuations in the mains voltage supply  IEC 61000-4-11	<p>&lt; 5 % <math>U_T</math> (&gt;95 % voltage peaks in <math>U_T</math>) for 0.5 cycles</p> <p>40 % <math>U_T</math> (60 % dip in <math>U_T</math>) for 5 cycles</p> <p>70 % <math>U_T</math> (30 % dip in <math>U_T</math>) for 25 cycles</p> <p>&lt; 5 % <math>U_T</math> (&gt;95 % dip in <math>U_T</math>) for 5 sec</p>	<p>&lt; 5 % <math>U_T</math> (&gt;95 % voltage peaks in <math>U_T</math>) for 0.5 cycles</p> <p>40 % <math>U_T</math> (60 % dip in <math>U_T</math>) for 5 cycles</p> <p>70 % <math>U_T</math> (30 % dip in <math>U_T</math>) for 25 cycles</p> <p>&lt; 5 % <math>U_T</math> (&gt;95 % dip in <math>U_T</math>) for 5 sec</p>	<p>The quality of the voltage supply should be commensurate with a typical commercial or hospital environment.</p> <p>If the user requires continued function from the bed when interruptions in the power supply occur, it is recommended that the bed be powered via an uninterruptible power supply or a battery.</p>
Magnetic field at supply frequency (50/60 Hz) IEC 61000-4-8	3 A/m	3 A/m	Magnetic fields at mains frequency should correspond to the typical values present in commercial and hospital environments.
Remark 1: $U_T$ is the mains AC voltage before the testing level is applied.			

**Table 204 – Guidelines and manufacturer's declaration – Electromagnetic compatibility  
for all devices and systems that are not life-sustaining (6.8.3.201 b))**

The bed is intended for use in the electromagnetic environment as described below. The customer or user of the bed should ensure that it is used in such an environment.

Compatibility check	IEC 60601 Testing level	Conformity level	Electromagnetic environment - guideline
<p>Conducted HF disturbances</p> <p>IEC 61000-4-6</p>	<p>3 Vrms</p> <p>150 kHz to 80 MHz</p>	<p>3 V</p>	<p>Portable and mobile radio equipment should not be used any closer to the bed, or their cables, than the recommended protective distance which is calculated based on the equation applicable for the transmission frequency.</p> <p><b>Recommended protective distance</b></p> <p><math>d = 1.17\sqrt{P}</math> 150 kHz bis 80 MHz</p> <p><math>d = 1.17\sqrt{P}</math> 80 MHz to 800 MHz</p> <p><math>d = 2.33\sqrt{P}</math> 800 MHz to 2.5 GHz</p>

 *Continued on next page.*



Compatibility check	IEC 60601 Testing level	Conformity level	Electromagnetic environment - guideline
Radiated HF disturbances  IEC 61000-4-3	3 V/m  80 MHz to 2.5 GHz	3 V/m	<p>Where <math>P</math> is the rated output of the transmitter in Watts (W) as specified by the transmitter manufacturer and <math>d</math> is the recommended protective distance in metres (m).</p> <p>The field strength of stationary radio transmitters should be less than the conformity level<sup>b</sup> at all frequencies, as verified by an on-site test<sup>a</sup>.</p> <p>Disturbance is possible in the environment of equipment that bears the following label.</p> 

Remark 1: At 80 MHz and 800 MHz, the higher frequency range applies.

Remark 2: These guidelines may not be applicable in all cases. The spread of electromagnetic parameters is influenced by the absorption and reflection of buildings, objects and people.

<sup>a</sup> The field strength of stationary transmitters, such as base stations of cordless telephones and mobile land radio, amateur radio stations, AM and FM radio and TV stations cannot be quantified in theory in advance accurately. To determine the electromagnetic environment in relation to a stationary transmitter, a study of the site should be considered. If the measured field strength at the site where the bed is used exceeds the conformity levels stated above, the bed should be observed to ensure that it functions correctly. If unusual features are observed, additional measures may be required, such as modified alignment or a different location for the bed.

<sup>b</sup> In the frequency range from 150 kHz to 80 MHz, the field strength should be less than 3 V/m.

**Table 206 - Recommended protective distance between portable and mobile HF telecommunications equipment and the bed – for devices and systems that are not life-sustaining (6.8.3.201 b))**

The bed is intended for operation in an electromagnetic environment in which HF disturbances are controlled. The customer or user of the bed can help to avoid electromagnetic disturbances by respecting the minimum distance between portable and mobile HF telecommunications equipment (transmitters) and the bed. The recommended minimum distance  $d$  is dependent on the maximum power output of the communication device (see below).

Rate output of the transmitter $W$	Protective distance according to the frequency of the transmitter $m$		
	150 kHz to 80 MHz $d = 1.17 \sqrt{P}$	80 MHz to 800 MHz $d = 1.17 \sqrt{P}$	800 MHz to 2.5 GHz $d = 2.33 \sqrt{P}$
0.01	0.12	0.12	0.23
0.1	0.37	0.37	0.74
1	1.17	1.17	2.33
10	3.69	3.69	7.38
100	11.67	11.67	23.33

For transmitters whose maximum rated output is not specified in the table above, the recommended protective distance  $d$  in metres (m) can be calculated using the equation in the column that features  $P$  as the maximum power output of the transmitter in Watts (W) as defined by the transmitter manufacturer.

Remark 1: At 80 MHz and 800 MHz, the higher frequency range applies.

Remark 2: These guidelines may not be applicable in all cases. The spread of electromagnetic parameters is influenced by the absorption and reflection of buildings, objects and people.





## Requirement for using the electronic instructions for use

In order to open the electronic version of these operating instructions (PDF file), you must have Adobe Reader 7.0.5 or later (or the corresponding Adobe Acrobat version) installed on your PC.

Adobe Reader is available for nearly all operating systems. The newest version can be obtained free of charge by download from [www.adobe.de/products/acrobat/readstep2.html](http://www.adobe.de/products/acrobat/readstep2.html) .

The electronic version of these instructions for use may be found on the Internet at [www.voelker.de](http://www.voelker.de).

## Trademarks

Adobe, Acrobat and Reader are protected or registered trademarks of Adobe Systems Incorporated.

Windows is a registered trademark of the Microsoft Corporation.

## Notes

**VÖLKER**

**Völker GmbH**

Wullener Feld 79 · 58454 Witten/Germany

Telephone +49 2302 960 96-0

Fax +49 2302 960 96-16

[www.voelker.de](http://www.voelker.de) · [info@voelker.de](mailto:info@voelker.de)