



5380



5380 K



Instructions for Use
Models 5380, 5380 K

VÖLKER

Help

Hyperlinks

Hyperlinks are cross-references in the text. They are marked with the  symbol. The entries in the Table of contents also have hyperlink functionality.

- Clicking  takes you to the relevant page.
- Clicking  in the Acrobat navigation bar takes you back to the start page.

Full-text search for a term

- Clicking  opens the "Search" window.

You can search for any term in this Acrobat document or optionally search all of the Acrobat files stored on your computer or those that are accessible.

Other interactive functions

The Adobe Reader and all Adobe Acrobat program versions offer the experienced user a whole raft of very useful functions for interactive working with documents. For more information, see the relevant user manuals or online help.

Display table of contents



Contents

2 of 84

Jump to Help page (this page)



Help

Version, Imprint, Type label

Instructions for Use G139

Version 1.0 (16.10.2012)

for Völker bed models 5380, 5380 K
produced after December 2011

© by Völker GmbH 2011-2012

Völker GmbH
Wullener Feld 79
58454 Witten

GERMANY

Tel.: +49 2302 96096-0
Fax: +49 2302 96096-16
e-mail: info@voelker.de
Internet: www.voelker.de

All rights reserved. Reproduction - even
in part - is not permitted.

We reserve the right to make changes
to reflect technical advances.

The contents of this document are sub-
ject to change without prior notification.

Customers are advised to contact the
responsible area sales manager before
placing an order.

Type label

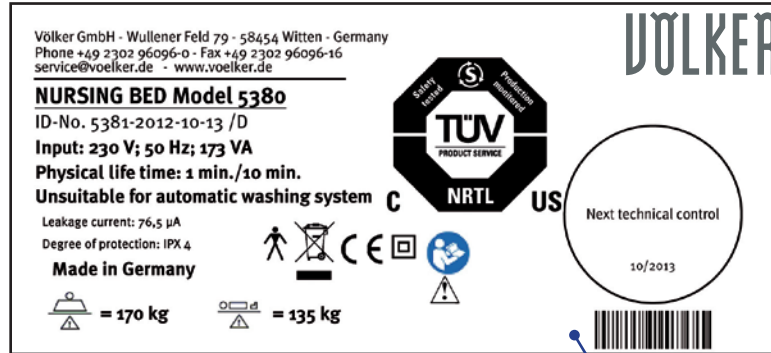

The type label is located on the inside of
the head panel.

Raise the back section to read the type
label.

For further information on the type label,
see Appendix  68.



Table of contents 1/2

Help  2

Version, Imprint, Type label  3

Table of contents  4

Foreword  6

Notes 7

General information  8

Designated purpose  9

General regulations, training/instruction of users, further requirements  11

General safety notes  12

Functional description 17

Overview  18

Hand control with hook  19

Transverse hand control (option)  20

Nurse keypad (option)  21

Nurse keypad with complete lock (option)  22

Nurse keypad with individual block (option)  23

Trapeze bar and accessory holders  24

Versions and options  25

Accessories  27

Activation 29

General operating instructions  30

Preparation  31

Electrical activation  32

Using the battery pack (option)  33

Taking out of service  33

Functional check  35

Operation 36

Key lock  37

Guide castors  38

Side rails  39

General safety notes  39

Side rails  40

Back section  42

Mechanical rapid lowering of the back section / CPR function (option)  43

Upper and lower leg sections  44

Lying surface height  45

Anti-Trendelenburg and Trendelenburg positioning (option)  46

Comfort seating position  47

Cleaning and disinfection 48

Cleaning  49

Wipe and spray disinfection  49

Spray lances and automatic washing systems  50

Maintenance 51

Staff training  52

Safety notes  52

Maintenance schedule  53

Technical check 54

Visual inspection  55

Functional check of the side rails  55

Functional check of the brakes  56

Functional check of the motors  56

Mains connection cable  56

Cabling  56

Housing  56

Mechanical check  56

Changing the battery  56

Measurement in accordance with DIN EN 62353  57

Checking the trapeze bar grab handle  57

Further accessories  57

Table of contents 2/2

Troubleshooting 58

Table of faults  59

Service points  62

Appendix 63

Symbols used  64

Technical data  65

Classification  67

Type label  68

Service life / disposal  70

Manufacturer's declarations, forms,
electronic instructions for use  71

Foreword

We are delighted that you have chosen Völker beds.

We are also grateful for the trust you have placed in our company and our products.

This step is undoubtedly the result of extensive considerations and examinations of the requirements that you require on new care or hospital beds based on your previous experiences.

You clearly had good reasons to choose Völker care beds.

We promise you that Völker beds will not disappoint you.

Not for nothing do Völker beds enjoy a worldwide reputation as particularly innovative medical aids. This concerns not only the design principle that has been completely redeveloped by Völker, but also refers to the multitude of product advantages which were continually tested and improved for their practicality. These will support the comfort of the occupant/patient and also help reduce the load of daily care work.

Now, every care or hospital bed has product features that are of practical benefit to their users. However, as far as we know, none of them offers the range of advantages that a Völker bed does.

Völker beds not only look great, but they also offer functions that can be controlled or adjusted mechanically, although most of them are controlled or adjusted using electric motors or electronic components.

If you purchase these beds, the responsibility for their correct and appropriate use is transferred to you. Consequently, we strongly advise that you consult the enclosed instructions for use to learn about the technical features, handling and use of all the functions.

We wish you every success with Völker beds,

Yours Völker GmbH

Notes

The **Notes** section contains information on the designated purpose of the product, as well as general safety notes.



CONTENTS

General information 📖 8

Designated purpose 📖 9

General regulations, training/
instruction of users, further
requirements 📖 11

General safety notes 📖 12

Notes | General information

General notes

You have purchased a bed from Völker GmbH. This bed has been built in accordance with the applicable national and international standards and regulations reflecting the current state of technology.

Völker beds satisfy requirements in terms of safety and functionality. They are tested in accordance with international standards and bear the CE mark, which documents the beds' compliance with essential requirements for medical products.

Please read the general safety notes  12. Please also note (with particular attention to any warranty claims) the further notes on the following pages.

Standard design

The standard design of the bed can be supplied with various options. A description of these options can be found in the section entitled Versions and options  25.

Copyright protection

These instructions for use may only be transferred to third parties with the written consent of Völker GmbH. All documents are protected under copyright.

Guarantee and liability

Völker GmbH is liable for any faults or failures, not including further claims arising in the context of the warranty obligations detailed in the main agreement. Claims for compensation, for whatever legal reason such claims may be raised, will not be entertained.

We reserve the right to make technical modifications without notice as part of the further development of the beds which form the subject of these instructions for use. All specifications are non binding. Printing errors excepted.

We accept no liability for damage and operational faults caused as a result of misuse and/or non-observance of these instructions for use.

The portrayal of the accessories does not necessarily match the actual product.

Notes | Designated purpose 1/2

Intended Use

Völker bed models 5380 and 5380 K are beds for medical use and are intended for the laying down and care of occupants/patients in care institutions and hospitals.

The bed is intended for use by people over the age of 12 or who are taller than 146 cm.

The safe working load of the bed is 170 kg. For calculation of the max. occupant/patient weight, 20 kg for the weight of the mattress and 45 kg for the accessories as well as the load that is borne by the accessories must be subtracted from the safe working load according to DIN EN 60601-2-52:2010 when using the bed in application environments 1 and 2 (intensive and acute care).

When using the bed in application environments 3, 4 and 5 (long-term, domestic and ambulant care), the values to be considered for the mattresses are 20 kg and 15 kg for accessories as well as the load that is borne by the accessories.

The maximum occupant/patient weight can therefore be taken from the following table:

Model	Safe working load	Max. occupant/patient weight	
		in application environment 1, 2	in application environment 3, 4, 5
5380	170 kg	105 kg	135 kg
5380 K	170 kg	105 kg	135 kg

Any use of the Völker bed other than for the purpose intended excludes the company from any possible liability.

Notes | Designated purpose 2/2

Inappropriate use

Inappropriate use can be dangerous. This includes, but is not limited to:

- Incorrect actuation of electrical functions and uncontrolled positioning
 - Operation of the care bed by the occupant/patient without having received prior instruction in how to do so
 - Use of other electrical equipment on the bed
 - Pulling on cables to move the bed
 - Removing electrical plug connections by pulling on the cable
 - Use of the bed on a slope of more than ten degrees of inclination (the bed's brakes are designed for an angle of inclination of no more than ten degrees)
 - Any attempt to move the bed while it is in braked position
 - Use of the bed to transport people
- Use of the bed for transport with a vehicle
 - Overloading of the bed beyond the specified safe working load.



CAUTION If, in an emergency situation, it is impossible to avoid putting children under the age of 12 or people who are less than 146 cm tall in the bed, protective covers must be placed on the side rails. This also applies to the use of the bed by weak or confused patients.

A use for children under 8 years of age is not permitted.



WARNING The bed may not be placed right next to or stacked up with other equipment. If operation near to or stacked up with other equipment is necessary, it must be ensured that the operation of the bed is observed and correct use in this arrangement is checked.

General regulations

The bed must only be operated and used in accordance with its designated purpose, in line with the conditions of the Medical Products Directive (MPG) and approved legislation pursuant to this, the generally-acknowledged rules of technology and the stipulations of occupational safety and accident protection guidelines. The bed must not be operated in a faulty state that could endanger its occupant/patient, care personnel or third parties.

User training

The bed may only be operated by individuals whose training or understanding and experience offer surety for correct handling (medical products directive).

User instruction

The thorough induction of care personnel in the operation of the bed can be provided by Völker or its representatives at the customer's request.

Attendance of such training can be certified and confirmed by Völker using the form provided for this purpose, specifying the name, date and signature.

Occupants/patients must be instructed in the use of the bed before care personnel hand over the hand control to them.

Other requirements

Whoever is in charge of the activation, operation or preparation of the bed must have been given a copy of these instructions for use (in printed or electronic form) and have read them.

To avoid operating errors and to safeguard the smooth operation of the bed, care personnel must always have access to the safety notes below.

Flooring requirements

We recommend using floors in the areas of bed access, which are classified and properly laid according to DIN EN 685 minimum class 32 or 33. These are floor coverings for areas intended for public and industrial use with moderate or heavy traffic.



Warning symbols

Information marked with this symbol must always be read and strictly observed.



DANGER represents an immediate threat of danger that can cause serious physical injury or death.



WARNING represents potentially dangerous situations that can lead to serious physical injury or death.



CAUTION represents potentially dangerous situations that can cause slight physical injuries.

NOTE warns of potential damage to objects or property.

Before first activation

Before the bed is put into action for the first time, care personnel must read these instructions for use in full and with care.

Before the bed is activated for the first time, care personnel must be instructed in the handling of the bed using the instructions for use. The potential dangers that can arise despite correct operation of the bed must also be pointed out in full.

Before and during use

Before each use of the bed, the user must be sure that the bed is in a proper condition and that safe use is ensured (Functional check  35).



WARNING If other devices are operated on the bed, which are provided with cables, air hoses or similar, make sure that these lines are routed so that they cannot become jammed in the moving parts or be damaged.

Position of the bed



CAUTION To avoid injuries caused by falling, we recommend (except while care is being given) that the bed is generally set at its lowest position with the guide castors fixed.

Transporting the bed



CAUTION The bed is not designed for transporting people. When moving the bed, it must always be ensured that the mains connection cable does not touch the ground and that the lying surface height is at least 35 cm. The bed should only be moved on a solid floor. Never attempt to push it over obstacles of over 1 cm in height. The maximum angle of inclination of the floor must not exceed 10°.

Securing the bed



CAUTION "Risk of accident" If the bed is not moved, the guide castors must always be fixed and latched into place, if necessary, since the bed may be required as a support for when the occupant/patient stands up or lies down. If the bed rolls away without the castors being braked, this can lead to a serious fall. After fixing the castors, check whether the bed is actually stationary and the guide castors with direction fixers are correctly latched into place for the optional, manoeuvrable variant. The bed can also be in a non-braked position after every activation or reactivation and it is therefore necessary to check that the guide castors are fixed properly.

One-sided load on the bed



NOTE In order to prevent one-sided loads on the bed, it must not be used as a seat for persons other than the occupant/patient (i.e. visitors must not sit on the edge of the bed).

Side rails



WARNING "Risk of entrapment"

In the case of occupants/patients whose physical or mental condition makes it necessary to use side rails to protect them from falling out of bed, the following safety measures must be observed:

- The legal permissibility of using side rails must be ascertained.
- The side rails may only be operated by trained care personnel.
- Ensure that the side rails (or parts thereof) are either fully raised and locked in position or completely lowered.

- It must be ensured that the occupant does not come into contact with the side rail elements when the electrical lying surface adjustment mechanism is actuated. It is also important to ensure that no part of the body is sticking out through the side rails.
- If the side rails are used with a person whose psychological condition makes their use necessary, then it must be ensured that the hand control is kept out of his/her reach or its functions are locked. In addition, it is strongly recommended that side rail covers are used.



- **DANGER** If these safety measures are not observed by care personnel, injuries can be caused to hands, knees, fingers, feet, legs and hips, along with haematomas and other injuries as a result of entrapment. In children or people who are less than 146 cm tall, non-observance of these guidelines can lead to death!



WARNING "Danger of injury"

If the side rails are damaged, the bed must not be used and must be repaired.

Notes | General safety notes 4/5

Height adjustment

 **DANGER "Risk of entrapment between the lower frame and/or floor and the bed frame when the bed is lowered"**

It must be ensured that no people, limbs, pets, bed linen or other objects are caught between the bed frame and the lower frame and/or floor.

 **DANGER "Danger of movement"**

If any movement of the bed could represent a danger to the occupant/patient, all functions must be locked.

Accessories

 **WARNING "Risk of injury"**
Only original Völker accessories should be used! Third-party accessories must undergo testing before use.

Use of lifting devices

 **WARNING "Risk of injury"**
No lifting device must be fastened directly to the bed (patient transport, repair).

The lifting devices specified are appliances that can be attached to the bed for transport purposes. Patient lifters can be used.

Use of oxygen equipment

 **DANGER "Risk of fire"**
Do not use any oxygen equipment other than that which is administered via nasal prongs or masks. Do not use this bed in a room where there is a risk of explosion.

Provided it has been excluded (e.g. based on information in the instructions for use of the equipment being used) that the use of the equipment may cause the O₂ concentration to rise to such a degree that there is an explosion risk, then the equipment can be used.

Rail spacers

When using the rail spacer, please read the separate instructions for use for this accessory. During technical checks, the rail spacers should also be checked to ensure they are suitable for the size of side rail used.

Notes | General safety notes 5/5

Cleaning and disinfection

In order to maintain consistent functioning, the bed should be cleaned, disinfected and tested as soon as possible following each use, so that it can be reused immediately without risk.

Incorrect cleaning/disinfection  48 of the bed can cause danger.

Maintenance and repair

Anyone responsible for carrying out maintenance and repair work must at least have received service training from Völker, have read the safety notes and the service manual and be qualified in accordance with MPBetreibV sections 4 and 6.

After maintenance work or repairs have been carried out, a technical check  54 must be carried out on the affected parts and/or functions. During this check, it must be determined that the

bed can be used in accordance with the specifications without risk to occupants/patients, users or third parties.

The technical check must be carried out at least once a year and after every lengthy period of non-use.

Any discernible damage, such as signs of wear and tear, loose screws or breaks/fractures must be eliminated immediately.

Electromagnetic and electrostatic faults

The beds in model series 5380 and 5380 K satisfy the EMC requirements in accordance with the law on medical products (MPG). The basis for testing is standard EN 60601-1-2.

Functional description

The features of the Völker care bed and its function are set out in the section **Functional description**.



CONTENTS

- Overview 📖 18
- Hand control with hook 📖 19
- Transverse hand control (option) 📖 20
- Nurse keypad (option) 📖 21
- Nurse keypad with complete lock (option) 📖 22
- Nurse keypad with individual lock (option) 📖 23
- Trapeze bar and accessory holders 📖 24
- Versions and options 📖 25
- Accessories 📖 27

Functional description | Overview

Head section
(Quick release,
model 5380 K,
see fig. on right)

Holders for trapeze
bars, drip stands etc.,
on both sides (in case
of model 5380 K addi-
tional holders for drip
stands at head and
foot end)

Height adjustment

Optional rapid lowering
of the back section (CPR)
for model 5380 K
(not shown)

Adjustable side rails
for back section, both sides

Adjustable
back section



Seat section,
fixed

Adjustable
upper leg section

Braking guide castors with
foot pedal (on both sides)

Hand control, transverse
(not shown)

Adjustable side rails for lower
leg section, both sides



Model 5380 K

Foot section (with
model 5380 K
quick release,
see fig. on right)

Adjustable
lower leg section

Nurse keypad, optional
(not shown)

Functional description | Hand control with hook

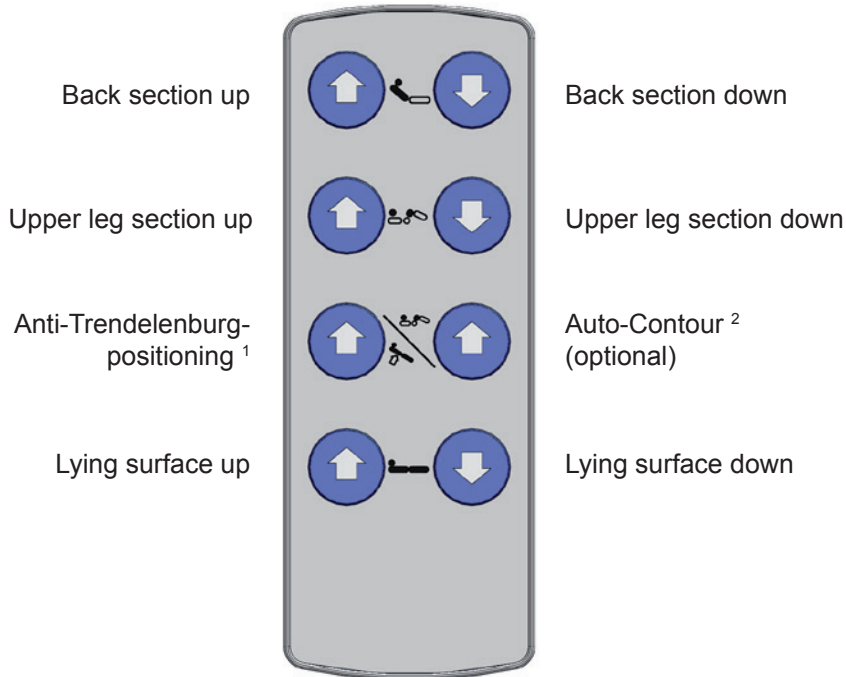

¹ Head end raised

² Back and upper leg section raised simultaneously

Reverse side:



Hand control locked



Hand control unlocked



WARNING When actuating motorised adjustments with the side rails raised, it must be ensured that the occupant/patient does not have any contact with the side rails, and that no parts of his or her body or those of other people are sticking through the side rails or are trapped between the lying surface and the lower frame and/or floor!

Functional description | Transverse hand control (option)

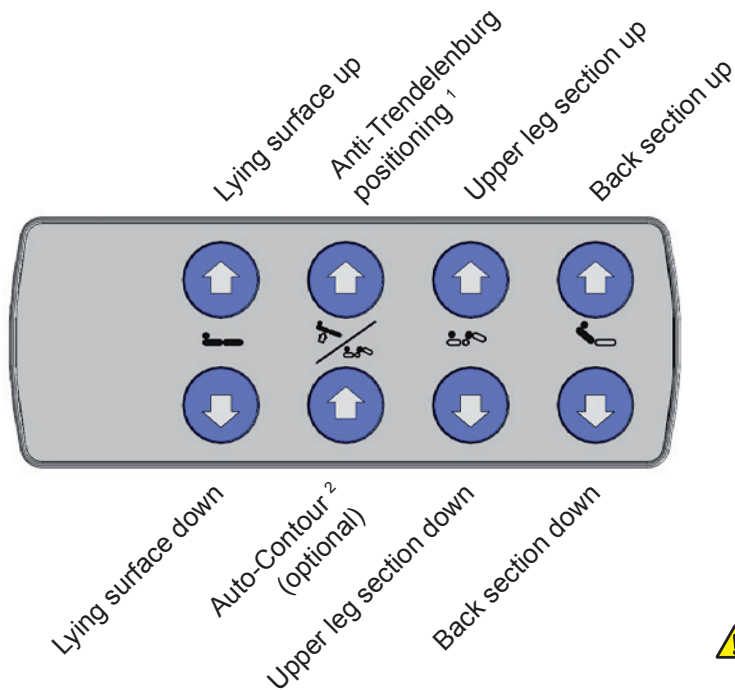

¹ Head end raised

² Back and upper leg section raised simultaneously

Reverse side:



Hand control locked



Hand control unlocked



WARNING When actuating motorised adjustments with the side rails raised, it must be ensured that the occupant/patient does not have any contact with the side rails, and that no parts of his or her body or those of other people are sticking through the side rails or are trapped between the lying surface and the lower frame and/or floor!

Functional description | Nurse keypad (option)

Double-click function "Lying surface up/down"

The nurse keypad can be equipped with an automatic function (double-click) on a country-specific basis.

With a double-click on the "Lying surface up" or "Lying surface down" button, the lying surface moves to the highest or lowest position, respectively. This function can be stopped at any time by pressing any button.



WARNING "Risk of entrapment"

If the double-click function is being used, the care giver must supervise the occupant/patient until the adjustment procedure has completed.



WARNING

If using a nurse keypad (option), this must always be mounted so that the occupant/patient cannot reach it.



DANGER "Risk of entrapment between the lower frame and/or floor and the bed frame when the bed is lowered".

It must be ensured that no people, limbs, pets, bed linen or other objects are caught between the bed frame and the lower frame and/or floor.

Functional description | Nurse keypad | Nurse keypad with complete lock (option)

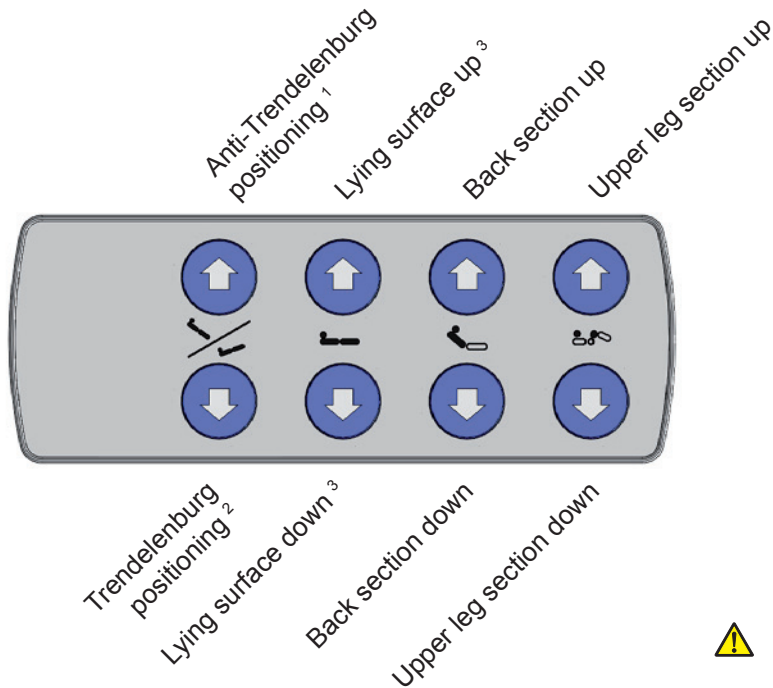

¹ Head end raised

² Head end lowered

³ automatic function with double click possible on a country-specific basis

Reverse side:



Hand control and nurse keypad locked



Nurse keypad unlocked



WARNING When actuating motorised adjustments with the side rails raised, it must be ensured that the occupant/patient does not have any contact with the side rails, and that no parts of his or her body or those of other people are sticking through the side rails or are trapped between the lying surface and the lower frame and/or floor!

Functional description | Nurse keypad | Nurse keypad with individual lock (option)

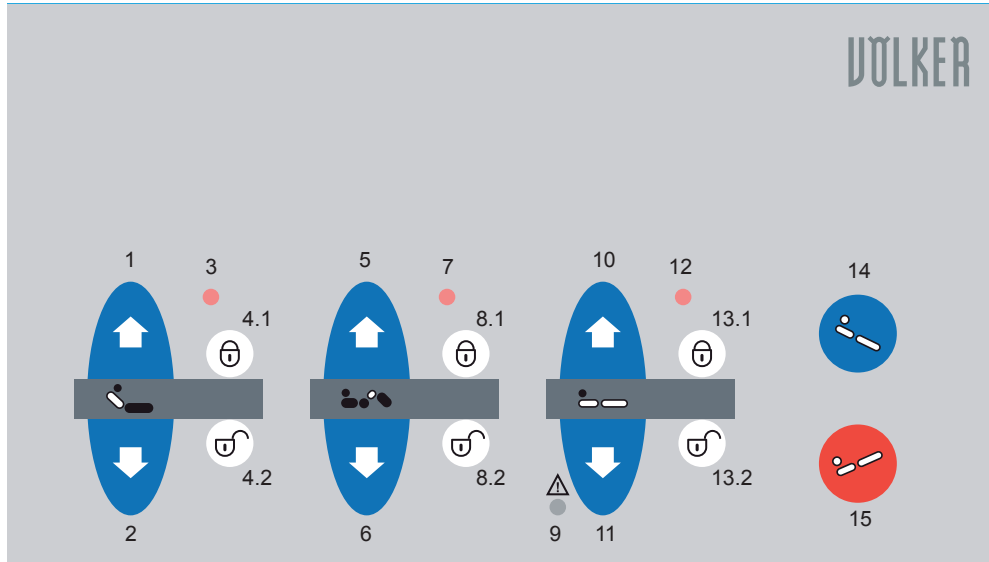

- 1 Back section up
- 2 Back section down
- 3 LED - Back section locking
- 4.1 Lock back section
- 4.2 Unlock back section
- 5 Upper leg section up
- 6 Upper leg section down
- 7 LED - Upper leg section locking
- 8.1 Lock upper leg section
- 8.2 Unlock upper leg section

- 9 LED - Lowermost position of the lying surface adjustment
- 10 Lying surface up ¹
- 11 Lying surface down ¹
- 12 LED - Height adjustment of the lying surface locked
- 13.1 Lock lying surface adjustment
- 13.1 Unlock lying surface adjustment
- 14 Anti-Trendelenburg positioning 2
- 15 Trendelenburg positioning ³

- ¹ automatic function with double click possible on a country-specific basis
- ² Head end raised
- ³ Head end lowered



WARNING When actuating motorised adjustments with the side rails raised, it must be ensured that the occupant/patient does not have any contact with the side rails, and that no parts of his or her body or those of other people are sticking through the side rails or are trapped between the lying surface and the lower frame and/or floor!

Functional description | Trapeze bar and accessory holders

On the inside of the head panel are holders for the trapeze bar and accessories. On model 5380 K, there are two additional sockets for drip stands at the head and foot ends, next to the protective wheels.

The trapeze bar and other accessories must be slotted into the holders until they audibly engage.

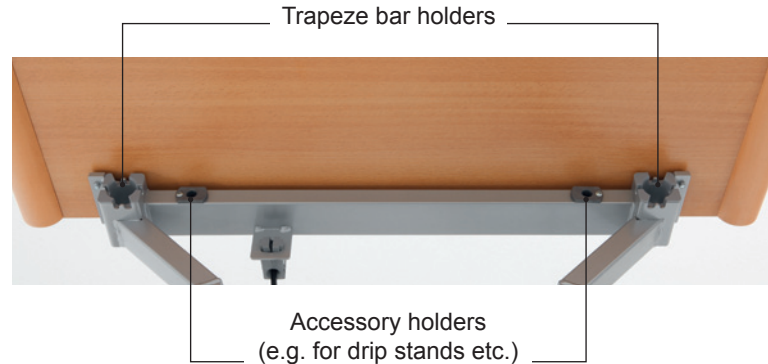

WARNING "Risk of Injury"

Ensure that the trapeze bar is completely slotted into the holder and securely seated.

Note: the safe working load of the trapeze bar is max. 75 kg.



WARNING "Risk of falling"

The trapeze bar must not be used by the patient as a means of climbing into the bed.

The trapeze bar must never jut out beyond the outer edge of the bed and then be used as a pulling-up aid (e.g. when getting out of a wheelchair).



WARNING Only original Völker trapeze bars should be used!

Functional description | Versions and Options 1/2

The standard design of the bed can be supplied with various versions and options.

Independent of the fastening option, there are optional hand control and nurse keypads with different function keys.

Version/Option	Description
----------------	-------------

Hand control (versions)	With hook (standard):
-------------------------	-----------------------



Transverse on the side rail with clip (option):	
---	--



Version/Option	Description
----------------	-------------

Nurse keypad with complete lock (option)	Transverse on the side rail with clip:
--	--



Nurse keypad with individual lock (option)	1. Transverse on the side rail with clip:
--	---



	2. On foot section with hook (optional):
--	--



Functional description | Versions and Options 2/2

Version/Option	Description	
Guide castors	The standard version has two castors at the head end and four castors at the foot end. The optional, manoeuvrable version has four guide castors at the head and foot end.	<p>These instructions for use cover all of the versions and options listed.</p> <p>Precise details of the supplied bed designs can be found in the order specifications for your beds. If the original bed specification is no longer available, please contact Völker Customer Services.</p> <p>Make a note of the Völker serial number (ID No.) on the type label  68 before you call.</p>
Side rails	<p>The bed can be equipped with various side rail versions:</p> <hr/> <p>Back/lower leg section*:</p> <ol style="list-style-type: none">1. Can be pulled out up to 34* cm (standard)2. Can be pulled out to 37 cm* (option) (not possible with model 5380 in Design FS or with model 5380 K in Design MA) <p>* Measured from the top edge of the side rail to the lying surface (without the mattress).</p>	

Functional description | Accessories 1/2

To offer the greatest possible degree of flexibility, Völker offers a wide range of easy-to-attach accessories. The beds are equipped as standard with holder devices for accessories, such as drip stands and trapeze bars.

Further information about accessories can be found in our current information brochure or on the Internet at www.voelker.de. Our staff will gladly provide you with more details on the accessories that are available for your bed model.

 **WARNING** Only original Völker accessories should be used!

Mattress

Mattress size	Mattress frame size	Density
88 x 200/220 x 12 cm	90 x 200/220 cm	40-50 kg/m ³
98 x 200/220 x 12 cm	100 x 200/220 cm	40-50 kg/m ³

To minimise the risk of injury, only use mattresses with the dimensions and properties detailed above. If you do not use Völker mattresses, please contact a dealer in whom you have confidence.

 **DANGER** If mattresses are used that do not match these specifications, there is a risk of suffocation!

 **DANGER** The height of the raised side rail above the mattress must always be greater than or equal to 220 mm; otherwise the occupant/patient may accidentally fall out of bed. Please note that the height of the mattress has a direct influence on this.

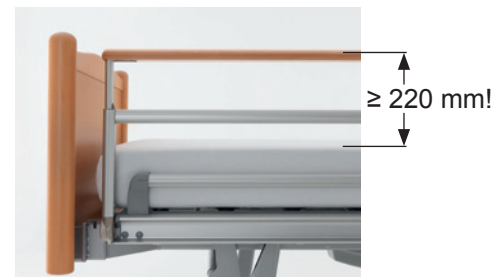

Functional description | Accessories 2/2

Use of securing systems

Securing systems such as belts or straps should only be used exactly as specified by the manufacturer.

If securing systems in the form of abdominal belts are used, then it must be ensured that the side rails are completely raised. In this case, the gap in the middle of the rails must be closed using a rail spacer.



DANGER When using securing systems and rail spacers, please note the separate instructions for use pertaining to these accessories.

The lying surface adjustment functions must be locked when a patient is restrained, and the hand control must be kept out of the occupant's/patient's reach!

To fix without using restraint holders, fasten the restraints on the corresponding longitudinal section of the lying surface frame. Make sure that the restraint is passed between the mattress holder and the mattress.

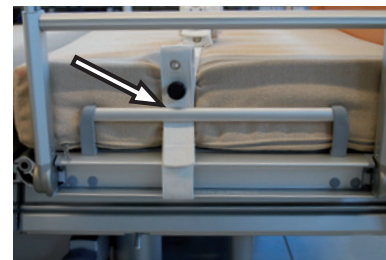

Activation

The section entitled **Activation** describes the preparation of the bed for use, including the functional check.





CONTENTS

General operating instructions  30

Preparation  31

Electrical activation  32

Using the battery pack (option)
 33

Taking out of service  34

Functional check  35

Activation | General operating instructions

On-time

The maximum on-time for the electro-motive bed functions is specified on the bed (type label 68) or in the technical data sheet.

1 min./10 min. means that each electro-motive adjustment may be operated for a maximum of 1 minutes, after which a pause of 10 minutes is necessary (protection against overheating).

NOTE Should the maximum on-time of 1 minute be exceeded repeatedly or for longer, safety cutout devices on the bed may cause the electromechanical motor system to shut down. The bed must not be manoeuvred using the motors until it has cooled down sufficiently!

Battery pack (option)

The battery pack in the bed has a charge capacity that is equivalent in theory to a constant operation of minimum 3 lifting and lying surface adjustments with a working load of 170 kg.

NOTE If the bed is parked at its location and the mains plug is not connected, this will cause the battery pack to discharge due to the buffering of the electronic components!

Deep-discharged battery packs can be damaged to the extent that premature replacement is needed!

Appropriate and correct use of the battery pack is essential for it to have a long service life!

In order to guarantee electrical functionality at all times, the bed should be connected to the mains as much as possible.

Safety cut-out device

The bed is equipped with an electrical, self-resetting safety cut-out device that prevents overloading of the motor systems. In the event of very severe overloading, the bed is automatically switched off.

Activation | Preparation

Installation conditions

The bed is only approved for use in dry rooms (technical data sheet). A mains power supply and possibly a potential equalisation connection are required for operation of the bed in any suitable room. When this is available and the building installation permits it, the bed should always be connected to the potential equalisation.

Mechanical activation

The supplied head and foot sections must be screwed onto the side panels (model 53380) or into the corner connections on the bed frame (model 5380 K).

Hand control connection

The hand control should be connected to the socket provided, where appropriate. The spiral cable must be routed so that it is not under tension.

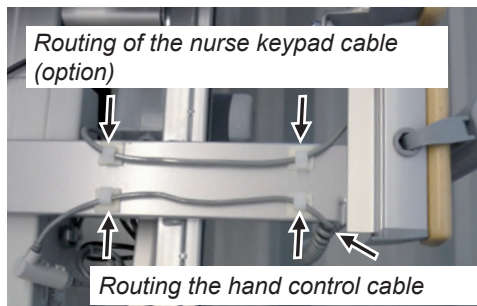

Bed transport

The bed can be moved without auxiliary transportation devices. For this, move the bed into the travel position (lying surface at a height of minimum 35 cm and release roller fixing  38).

NOTE The standard version of the bed can only be controlled from the foot end.



CAUTION The bed is not designed for transporting people. If a patient is lying in the bed, it must only be pushed within the room. The bed should only be moved on

a solid floor. Never attempt to push it over obstacles of over 1 cm in height. The maximum angle of inclination of the floor must not exceed 10°.

The bed can be transported by one person on even surfaces. If the bed has to be moved over falling or rising surfaces, the bed may only be transported by at least two people holding the bed at the head and foot section for the safety of the care personnel owing to the ease with which the castors roll.



Activation | Electrical activation

⚠ WARNING Ensure that the plug connection between the mains cable and the lying surface adjustment motor is correctly positioned!

⚠ WARNING Check the mains cable for damage. If the cable is damaged, the bed must not be used and must be taken out of service immediately!

NOTE Please be aware that incorrect handling of the mains isolation can lead to the battery pack no longer charging. Incorrect handling includes actions such as dropping the mains isolation, pulling the cable of the mains plug to remove it from the socket, clamping the mains cable between the lying surface and lying surface frame as well as running over the cable when transporting the bed.

1. Connect mains plug to mains socket.
2. Press the green button on the mains isolation switch for one second to isolate the mains connection.



3. Unlock the locking switch on the rear of the hand control and the nurse keypad (option) using the key (open lock visible) in order to activate the bed's electrical functions.

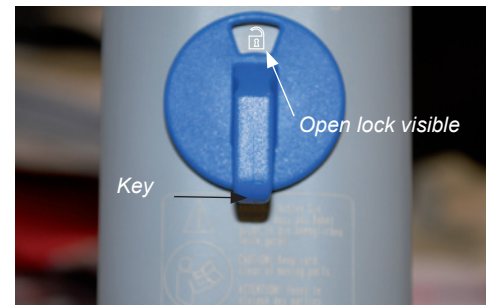

NOTE The mains isolation switch ensures that when no electrical function is being actuated, there is no mains voltage to the bed.

Exception: While the battery pack (option) is loaded or the nurse keypad (option) is activated.

Activation | Using the battery pack (option) 1/2

The battery pack (option) allows the bed to be operated independently of the mains supply for at least three adjustment cycles under full load.

The LED on the battery pack displays three colours:

Green	The battery pack is connected to the mains supply. The charging cycle is running.
Yellow	The battery pack is being charged. The bed should not be disconnected from the mains supply.
Red	DANGER ZONE. The battery pack must be charged. The bed cannot be operated independently of the mains supply.
All lights off	The battery pack is fully charged: The mains cut-off is activated. No current flows in standby mode.

If you hear a beep, the battery pack needs to be recharged. The beep becomes weaker as the battery pack's charge diminishes. The battery pack is switched off shortly before deep discharging. After the bed is connected to the mains supply, press any button on the hand control to render it fully functional again. The battery pack is charged when it is connected to the mains after every use or if the charge has fallen too low.

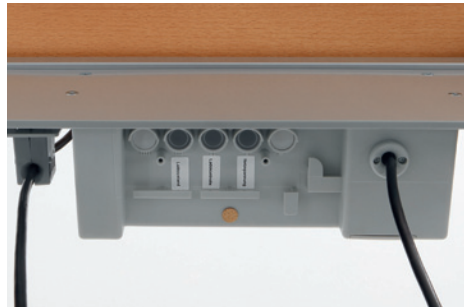

NOTE If the bed is stored for a long period without being connected to the mains supply, the battery pack can discharge. The degree of discharge depends on environmental conditions.

NOTE During the charging cycle, the battery pack is connected to the mains supply and is therefore supplied with electricity. The LED displays the battery pack's charging status during the charging cycle. The current cut-off is deactivated and current flows to the bed.

⚠ WARNING If electromagnetic interference occurs with other equipment in the area around the bed, please refrain from using these devices. When the bed is being transported, it must always be handled carefully and protected from moisture.

Activation | Using the battery pack (option) 2/2 and taking out of service

NOTE The bed is designed for use in an ambient temperature range from 10 °C to 40 °C, with a relative humidity of 30% to 75% and an air pressure of 700 to 1060 hPa.

WARNING The battery pack (option) must only be replaced by personnel trained by Völker GmbH.

WARNING If the battery pack is faulty, degassing can occur. In rare cases, this can cause deformation of the battery pack housing. If this occurs, the bed must be immediately taken out of service and taken to an adequately ventilated room without sparks (from electricity or fire). Immediately inform customer services should this occur!

WARNING The battery pack (option) must be disposed of in an environmentally responsible manner using the appropriate services. Alternatively, you can return it to Völker GmbH for disposal.

To activate the hand control and the nurse keypad once the bed has been activated, the function key lock must be disabled  37.

Taking out of service

The bed is taken out of service by disconnecting it from the mains supply. To do this, the mains plug is disconnected from the mains socket and, if necessary, the optional battery pack disconnected from the control unit. If the bed is to be out of service for a period longer than two weeks, then the 9V battery must also be disconnected from the motor.

To disconnect the 9V block battery, remove the two screws from the battery compartment lid on the two-side drive.



Then pull the contact strip off the battery.

Activation | Functional check

Visual inspection

Before each new occupancy of the bed, the following checks must be carried out:

1. Ensure the bed exhibits no visible signs of damage.
2. Ensure that the insulation of the electrical cables is intact.
3. Ensure that the next testing date has not been missed (see testing label).



WARNING Only undamaged beds that are still within their testing interval periods may be used!

Function test

A functional check must be carried out before each new occupancy:

1. All electrical functions must be actuated to their terminal positions once.
2. The function of all side rails must be checked.
3. The secure position of the bed must be checked.











Once a fault-free functional check has been carried out, the bed is ready for use.

Operation

The **Operation** section provides you with all the information required to operate the Völker bed.



CONTENTS

- Key lock  37
- Guide castors  38
- Side rails  39
 - General safety notes  39
 - Side rails  40
- Back section  42
- Mechanical rapid lowering of the back section / CPR function (option)  43
- Upper and lower leg sections  44
- Lying surface height  45
- Anti-Trendelenburg and Trendelenburg positioning (option)  46
- Comfort seating position  47

Operation | Key lock

Activating the hand control key lock disables all of the functions of the hand control.

The locking switches are located on the reverse of the hand control and the nurse keypad with complete lock (option). They are unlocked (open lock visible) and locked with the key.

If the bed functions cannot be actuated, check whether the key lock is activated.

The key should be removed from the bed when it is not required.



Hand control or nurse keypad (option) locked



Hand control or nurse keypad (option) unlocked

If the nurse keypad (option) is locked, the hand control is also automatically locked (system lock).

If only the hand control is locked, the nurse keypad (option) retains its full functionality.

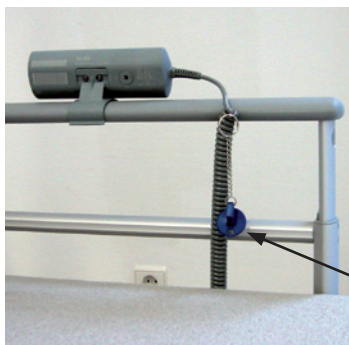

Key

Operation | Guide castors

The standard version of the bed has two rigid castors on the head side and four guide castors on the foot side, two of which are adjustable.

The optional, more manoeuvrable variant is also provided with four guide castors on the head side, two of which have direction fixers.

To move the bed, the roller fixing must be released by operating the foot pedal. When moving the bed, the lying surface must be at a height of at least 35 cm.



CAUTION "Risk of accident"

If the bed is not moved, the guide castors must always be fixed and latched into place, if necessary, since the bed may be required as a support for when the occupant/patient stands up or lies down. If the bed rolls away without the castors being braked, this can lead to a serious fall. After fixing the castors, check whether the bed is actually stationary and the guide castors with direction fixers are correctly latched into place for the optional, manoeuvrable variant.

NOTE The bed is not suitable for transporting the occupant/patient.

Fix guide castors

1. To fix the rollers, tread on both foot pedals of the guide castors at the foot end until they latch into place.



2. To fix the optional guide castors with direction fixers at the head end, step on both foot pedals at the head end. The direction fixers are not correctly fixed until the foot pedals are down and the castors can be heard latching into place parallel to the length side of the bed after turning slightly.

Loosen guide castors

Press the foot pedal of the guide castors upwards with your foot to loosen the fixed guide castors.



WARNING All people whose duties involve manoeuvring of the side rails must have read and understood the following information:

- During actuation of the back, upper leg or lower leg section adjustment, of the lift or of the side rails, it must always be ensured that the occupant/patient is not touching the side rails, and that no part of his/her body is sticking out through the side rails.
- If the side rails are used for an individual whose psychological condition necessitates their use, it must be ensured that the hand control is stored completely out of his/her reach or its functions are completely locked. In all cases, care must be taken to ensure that entrapment risks are minimised.
- Protective covers (cot side pads) are available as an accessory for the side rails. These provide additional protection against injury from contact with the side rails. Even with the covers, the care staff or occupant/patient must still take the necessary care when operating the bed.
- If the side rails are used, they must always be either completely raised and securely engaged, or completely lowered to the end stop. Because of the risk of entrapment, they must never be left in a position where they are not completely engaged.
- If the side rails are damaged, there is a risk that the patient will fall out of bed.

Operation | Side rails 1/2

Raising the side rails

1. Pull the side rail element out horizontally until the end stop, and raise it upwards.
2. To adjust the height of the side rail, pull the telescopic section upwards until it reaches its end stop.

Lowering the side rails

1. Press both buttons on the outside of the frame, right under the cross-member, to bring the height-adjustable side rail element to its lowest position.



2. Press the "Drücken / Press" trigger at the lower edge of the side rail element and tilt it sideways into the horizontal plane, so that it lies parallel to the floor.



3. Push the rail element completely underneath the lying surface.

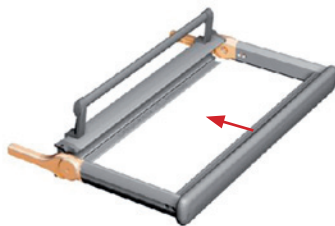

The side rail elements can be used individually or together as required to protect the occupant/patient.

Raising all four rail elements offers the occupant/patient maximum protection.

⚠ WARNING The side rails should always be gripped with two hands at the ends of the element in question and guided upwards or downwards.

⚠ CAUTION Any weight on side rail elements that are pulled out horizontally must not exceed 15 kg!

Operation | Side rails 2/2

NOTE Due to their exceptional stability, the side rail elements can also be used as a surface for storing bed clothes (max. 15 kg) or as an additional supporting surface for care-related positions, such as Bobath treatments, or for the delivery of physiotherapy-related treatments.

Operation | Back section

The back lying surface can be adjusted using the hand control or the nurse keypad (option).

If necessary, release the lock of the hand control or nurse keypad (option)  37 auf.

The back section of the lying surface can be raised up to an angle of max. 70°.

 **WARNING** When the back section is being raised with the side rails up, it must be ensured that none of the occupant's/patient's or any other person's body parts are sticking out through the side rails or are on top of them!



Back section up/down

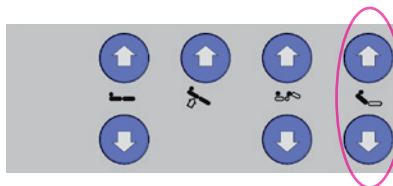

Hand control

Back section up/down

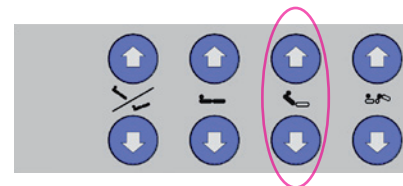

Nurse keypad (option)

 **WARNING "Risk of entrapment"** When adjusting the position of the back section, do not touch the frame in the area of the back section!



Operation | Mechanical rapid lowering of the back section / CPR function (option)

The bed can optionally be fitted with a mechanical rapid lowering function of the back section for resuscitation.

WARNING The CPR function (Cardiopulmonary Resuscitation function) may only be operated by qualified personnel!

Hold the back section on the mattress holder and pull the red lever located at the left or right underneath the back section of the lying surface upwards to lower the back section rapidly. The back section can now be moved quickly downwards. The lowering process can be interrupted by letting go of the red lever.

WARNING The back section must always be held on the mattress holder so that the bed is not lowered suddenly with the occupant/patient!

Red lever for mechanical rapid lowering of the back section for resuscitation:



Operation | Upper and lower leg sections

The position of the upper leg lying surface can be adjusted using the hand control or the nurse keypad (option).

If necessary, release the lock of the hand control or nurse keypad (option)  37.

The upper leg section of the lying surface can be raised up to an angle of max. 45°.

The lower leg section can be moved manually to any position of maximum 16° by pulling on the mattress holder.

To lower the lower leg section, the mattress holder is pulled and the section lifted to the end stop and then lowered. The locking mechanism is disengaged automatically.

 **WARNING** When the upper or lower leg section is being raised with the side rails up, it must be ensured that none of the occupant's/patient's or any other person's body parts are sticking out through the side rails or are on top of them!

 **WARNING "Risk of entrapment"** When the position of the upper leg section is being adjusted, there is a risk of entrapment between the raised side rail and the foot section.



Upper leg section up/down

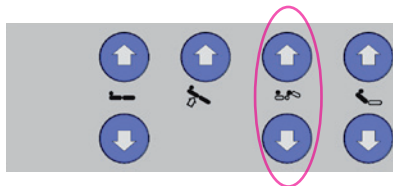

Hand control

Upper leg section up/down

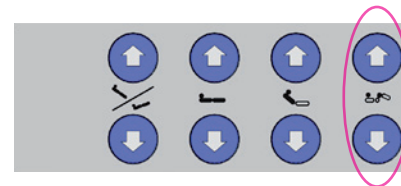

Nurse keypad (option)

Operation | Lying surface height

The position of the entire lying surface can be adjusted using the hand control or the nurse keypad (option).

If necessary, release the lock of the hand control or nurse keypad (option)  37.

The lying surface height can be adjusted from 23 cm to 78 cm (in the optional version with CPR from 25 to 80 cm).

 **WARNING** To avoid dangers to the occupant/patient from falling, we recommend that the bed be lowered all the way except when delivering care!

 **DANGER** Before lowering the bed, it must be ensured that no people, limbs, pets, bed linen or other objects are trapped between the lying surface and the lower frame or floor. When getting onto and off the bed, it must be ensured that the bed is stable (fix guide castors and possibly optional direction fixers)!



Lying surface up/down

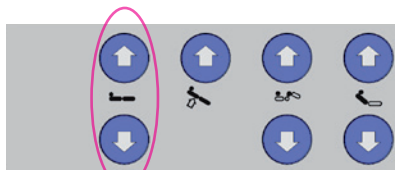

Hand control

Lying surface up/down

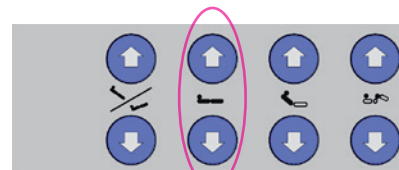

Nurse keypad (option)

 **WARNING** When the height adjustment mechanism is actuated with the side rails up, it must be ensured that the occupant/patient does not have any contact with the side rails, or that any parts of either the patient's body or of other persons are sticking through the side rails!

Operation | Anti-Trendelenburg ¹ and Trendelenburg positioning (option) ²

Trendelenburg positioning can only be set using the nurse keypad (option).

If necessary, release the lock of the nurse keypad  37.

The Trendelenburg position can be adjusted up to an angle of 12°.

 **CAUTION** If a fault occurs with the lifting function, or the mains power supply fails and the battery pack is completely discharged, the Trendelenburg function cannot be engaged. The occupant/patient may have to be placed in a different bed!

 **WARNING** Since the Trendelenburg positioning depends on clinical indications, it must only be used with appropriate approval.

The lying surface is automatically returned to its horizontal position if it is moved to its highest or lowest position.



Anti-Trendelenburg positioning ¹



Anti-Trendelenburg positioning ¹
Trendelenburg positioning ²

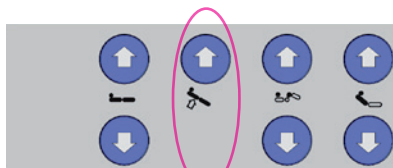

Hand control

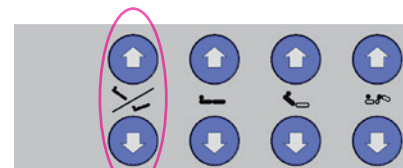

Nurse keypad (option)

¹ Head end raised

² Head end lowered

Operation | Comfort seating position



Occupants/patients who are unable to leave the bed either because their circulatory system is too unstable or they first have to be "taught" how to sit can gain a lot of benefit from the comfort seating position. This ensures an active seated posture in the bed.





Anti-Trendelenburg positioning





Auto-Contour

Hand control with anti-Trendelenburg positioning and Auto-Contour (option)

Adjusting the comfort seating position

1. Move the back  and upper leg section  upwards slightly into a comfortable position. You can alternatively reach this position in one step by pressing the Auto-Contour button  (option).
2. Swivel the bed to the comfort seating position by pressing the Anti-Trendelenburg button .

Restoring the straight lying surface

To return to a horizontal lying position, move the lying surface  as well as the back  and upper leg section  into the lowermost position in any order.

Cleaning and disinfection

This section contains details on the **cleaning and disinfection** of the bed.



CONTENTS

Cleaning 📖 49

Wipe and spray disinfection 📖 49

Spray lances and automatic washing systems 📖 50

Cleaning and disinfection 1/2

In order to maintain consistent functioning, the bed should be cleaned, disinfected and tested as soon as possible following each use, so that it can be reused immediately without risk. Incorrect cleaning/disinfection of the bed can cause danger.

Cleaning

Depending on the degree of soiling, we recommend cleaning the bed with a damp cloth or similar.

Wipe and spray disinfection

For wipe and spray disinfection, the disinfecting agents featured in the VAH (Verbund für angewandte Hygiene e.V.) list dated 01.03.2011 can be used in their specified concentrations in Germany. They must be applied at the dilution ratio specified by the relevant manufacturer's instructions for use. The list can be obtained under ISBN Number 978-3-88681-106-9.

NOTE Solvents are not permitted.
Grinding agents, scouring pads or other dulling substances must not be used.
Organische Lösungsmittel wie halogenierte / aromatisierte Kohlenwasserstoffe und Ketone dürfen nicht verwendet werden.

The following instructions must be noted when using cleaning and disinfecting agents:

- The working solutions should generally be freshly prepared.
- The concentrations used should be neither higher nor lower than those given in the list. The so-called "shot" method should not be used under any circumstances. Under no circumstances should someone using a disinfectant follow their own judgement to add a detergent such as a soap or detergent substance (leads to soap failure).

- There is a risk of fire or explosion from alcoholic spray disinfectants when these are used over large areas.
- They must not contain any corrosive or irritant components.
- They must not contain any substances that change the surface structure or gripping properties of the materials.
- Lubricants must not be affected.
- The pH value of the water must be no higher or lower than 6-8.
- Water should not exceed a total water hardness of 0.9 mmol/l (corresponding to 5 °dH).

Cleaning and disinfection 2/2

The specifications in the VAH list, as well as the specifications we have issued do not absolve the user of the obligation to carry out his or her own checks and investigations, since the ratios (e.g. water hardness) can vary depending on the geographical location. It is therefore impossible to offer legally binding assurance of certain properties.

If unsuitable washing and disinfecting agents are used, if the mixing ratio is incorrect or if there is inadequate care of the beds, damage can occur to the surface coating for which Völker GmbH is not liable.



WARNING "Risk of electric shock / fire and functional failure"

The bed must always be disconnected from the power supply during cleaning and disinfection.

The plug and the socket of the hand control are only protected against spray when the control is stowed and the appropriate cover is in place.

Spray lances and automatic washing systems

Cleaning and disinfection using spray lances from high-pressure cleaning equipment and in automatic bed washing systems is not permissible.

Maintenance

The **Maintenance** section contains information on how to carry out maintenance work.

CONTENTS

Staff training  52

Safety notes  52

Maintenance schedule  53



Maintenance | Staff training, safety notes

Staff Training

Every person involved with maintenance or servicing must at least

- have taken part in service training by Völker
- have read the safety notes and
- the service manual

and be qualified in accordance with MPBetreibV §§ 4 and 6. To avoid errors and ensure that our beds work properly, these documents must always be accessible to service personnel.

Before commencing maintenance work, the service manual and the instructions for use must be read in full by the person responsible for carrying out the servicing.

Safety notes

During maintenance and technical checks, the following specifications must be strictly observed:

- The room's electrical installations must satisfy current technical requirements and the bed must be used correctly.
- All the bed's foot pedals must be fixed and the direction finders must latch into place (bed is fixed) in the optional, manoeuvrable version.
- The beds are not protected against explosion and must therefore only be maintained in an environment free from flammable substances and materials.

 **WARNING** Before carrying out any repair work, always disconnect the mains plug and disconnect the bed from the battery pack (option)!

 **WARNING** Maintenance and repair work should only be carried out after the bed has been disinfected.

 **WARNING** Maintenance and repair work should only be carried out on an unoccupied bed. The resident/patient may also have to be transferred to another bed before the work.

 **WARNING** After maintenance (repair) work is complete, always check that the bed is functioning correctly. It must be checked that the bed can be used correctly without risk to the occupant/patient or care personnel.

Maintenance | Maintenance schedule

The bed requires little maintenance. All movable parts for the height adjustment mechanism, the lying surface motor systems and the side rails are provided with long-lasting lubricant at the factory. It is recommended that the bed is subjected to a regular, or at least once a year, technical check [☞ 55](#) **(including visual inspection and functional check) as described in the checklist [☞ 80](#)** and any damage uncovered as a result, such as signs of wear and tear, loose screws or breaks/fractures, be eliminated immediately.

After every lengthy period of non-use, a technical check [☞ 55](#) must be carried out.

Period	Works to be performed
Annually and after lengthy periods of non-use	Technical check ☞ 55
Every 2 years*	Replace the 9V block battery (see below)
If required,	Lubrication of mechanical parts, replacement of the battery pack in case if defective, replacement of wearing parts if defective <ul style="list-style-type: none">• Wings (if fitted)• Spring elements (if fitted)

Replace the battery

To replace the 9V block battery, remove the two screws from the battery housing on the double drive.

Use only brand-name batteries, and dispose of spent batteries in an environmentally friendly way.



* as well as after every electrical emergency lowering.













Technical check

The section entitled **Technical check** contains all the information needed to carry out the technical check in accordance with MPBetreibV, BGVA3, UVV on hospital and care beds and measurement as per DIN EN 62353. Other (e.g. country-specific) specifications have not been included here. This does not absolve the operator from the obligation to observe any such specifications.

Technical check of Völker hospital and healthcare beds in accordance to German standards and safety regulations incl. measurements required

Project, address, customer no.:					
Type of bed, product, location of the bed:					
Bed identification (e.g. facilities own identification or Völker ID-no.):					
Date of check:		Name of technician:			
Kind of check	Component to be checked	Annually	Accepted	Not accepted	Not applicable
Visual inspection	Inscription on device readable				
	Instructions for use available				
	Base frame	B*			
	Lying surface, wing and spring elements (if existing)	B*			
	Trapeze bar adapter, infusion bar adapter	B*			
	Power supply cable, plug or charger, charging connection	B*			
	Strián relieve, bend protection, cable hook	B*/S*			
	Connecting cable, plug-in contacts, blind plugs	B*/S*			
	Positioning (spacing 1 mm) and sensor cabling (only Vis-a-Vis-bed)	B*/S*			
	Housing (motor, control electronics)	B*			
	Hand control (housing, cable)	B*			
Nurse keypad nurse hand control (housing, cable)	R*				

CONTENTS

- Visual inspection  55
- Functional check of the side rails  55
- Functional check of the brakes  56
- Functional check of the motors  56
- Mains connection cable  56
- Cabling  56
- Housing  56
- Mechanical check  56
- Changing the battery  56
- Measurement in accordance with DIN EN 62353  57
- Checking the trapeze bar grab handle  57
- Further accessories  57

Technical check 1/3

1. Visual inspection

Check the frame parts for plastic deformations and/or wear and tear. These include the lower frame, the lifting mechanism, all parts of the lying surface (back, seat, upper leg and lower leg sections, wings and spring elements (if fitted)), trapeze bar, trapeze bar holder and guide castors.

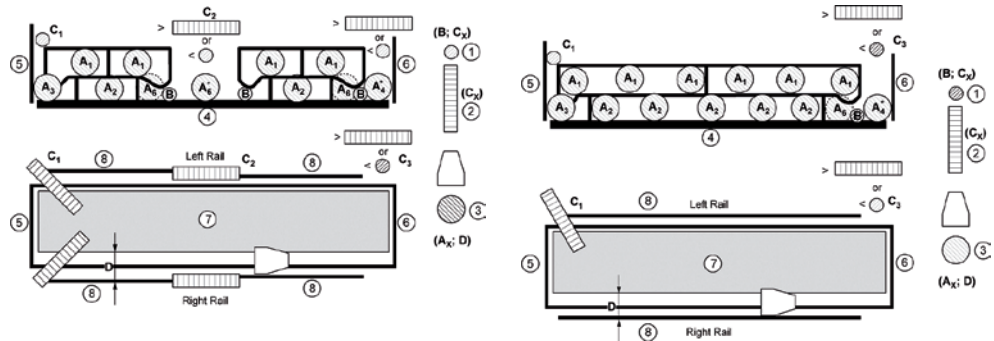

2. Functional check of the side rails

The side rails must be checked in accordance with DIN EN 60601-2-52.

Check that the locking mechanism for the side rails is working correctly and that there are no visible deformations or signs of wear and tear on the side rails.

Check that the prescribed distances are maintained, even when the side rails are placed under load. All measurements of the side rail distances should be made in the flat lying surface position, since the dimensions given while the bed is otherwise positioned do not show less favorable conditions.

Letter	Description	Dimension
A _x	The distance between elements within the scope of the SIDE RAIL in its raised/engaged position or of the area formed by the SIDE RAILS and the fixed parts of the BED or ACCESSORIES.	< 120 mm
B	NOT APPLICABLE	-
C ₁	Distance between HEAD SECTION and SIDE RAIL	< 60 mm
C _{2,3}	Distance between divided SIDE RAIL and distance between SIDE RAIL and FOOT SECTION	< 60 mm or > 318 mm
D	Area between SIDE RAIL and MATTRESS	120 mm cone may sink max. 60 mm under the mattress surface without pressure
G	Height of the upper edge of the SIDE RAILS over the mattress without compression over at least 1/2 of the length of the LYING SURFACE	≥ 220 mm

Technical check 2/3

The measurement of A and D must be performed using a cone as defined in DIN EN 60601-2-52. The force used for measurement A must be at least 250 N.

3. Functional check of the brakes

Check that the brake is functioning correctly (braked, steer, free running).

4. Functional check of the motors

Travel through the full adjustment range of each motor. Look out for any unusual noises, watching the speed, ease of running etc., and check that the selected function travels in the correct direction. Particularly ensure that the motor switches off automatically when it reaches its terminal position* (terminal position switch).

* Please note that the terminal position can vary from bed model to bed model. Please consult the technical specifications for this, or if in doubt, contact our service department.

5. Mains connection cable

Check

- the mains connection cable, including cable guides,
- the strain relief, including kink protection sleeve,
- the mains connection plug
- the cable hooks

for damage.

6. Cabling

Check the cable guides and that the plug connectors are correctly seated and do not exhibit any damage.

Check the cables for damage.

7. Housing

Check all housings for damage. All screws must be firmly tightened and seals must not exhibit any visible damage.

8. Mechanical check

Check the function of the Rastomat by manually moving the lower leg section to the individual positions.

9. Changing the battery

Please replace the 9 V block battery every 2 years and each time after operating the electrical emergency lowering. Only use brand-name batteries and dispose of the old ones in an environmentally responsible manner (Replacing the batteries  53).

Technical check 3/3

10. Measurement as per DIN EN 62353

The bed must be checked electrically in accordance with DIN EN 62353. The leakage current should be measured by means of alternative measurement. The max. measured value must be less than or equal to 500 μ A.

On beds with a potential equalisation connection (see diagram below), the impedance of the potential equalisation within the bed must also be measured. The impedance must be no less than 0.2Ω ($I=5\dots 25 \text{ A}$, $R=U/I < 0.2 \Omega$).

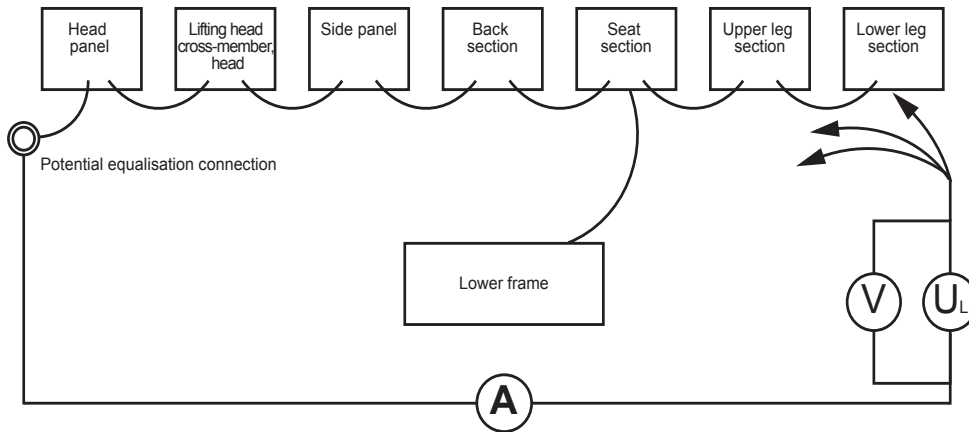

11. Trapeze bar grab handle

Check whether the plastic and holding frame of the trapeze bar grab handle exhibit any damage and that the fixing rods on the trapeze bar are intact.

The handle of the trapeze bar and fastening strap must be replaced in the following cycle:

- Every 5 years: Trapeze bar grab handle and trapeze bar grab handle with roll function in elderly care service
- Every 3 years: Trapeze bar grab handle with roll function in hospital service.

12. Further accessories

Further accessories must always be checked in accordance with the manufacturer's instructions.

Troubleshooting

The section entitled **Troubleshooting** contains a table of faults for users, together with information on the service points.

CONTENTS

Table of faults  59

Service points  62

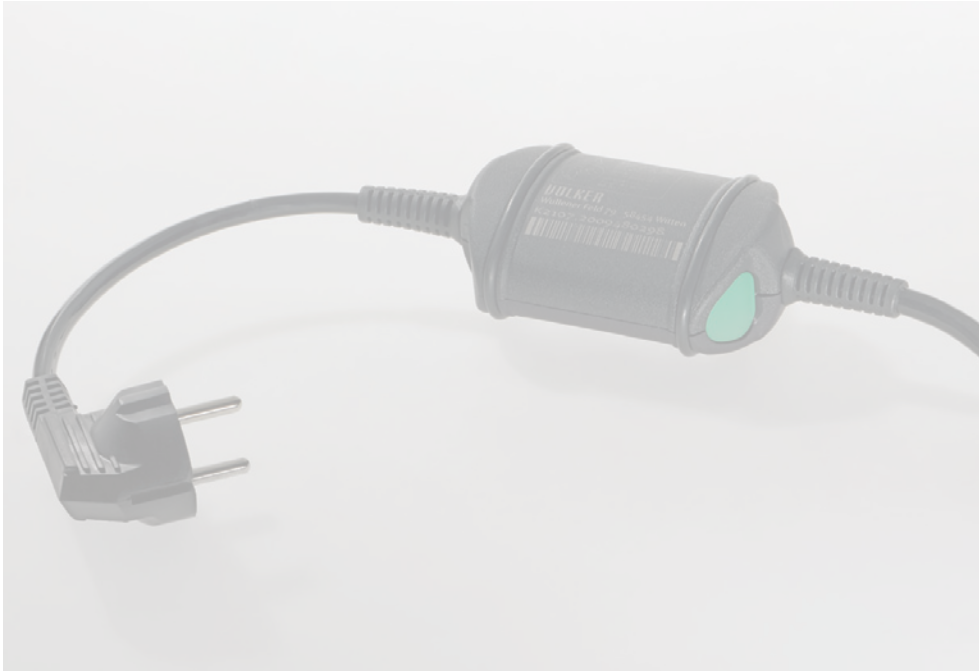

Troubleshooting | Table of faults 1/3

The table below contains information on possible problems that users can resolve themselves.

Faults that can only be eliminated by technical engineers are described in the service manual.









Anyone responsible for carrying out maintenance and repair work must at least have received service training from Völker, have read the safety notes and the service manual and be qualified in accordance with MPBetreibV sections 4 and 6.

NOTE Before carrying out any troubleshooting, check whether bed is connected to the mains supply (the mains plug is in a live socket) and the battery pack (option) is charged (the yellow LED flashes during the charging process at intervals commensurate with the charge level).



WARNING Before carrying out any repair work, ensure that the bed has been disconnected from the power supply and the battery pack (option) has been disconnected if present.

Troubleshooting | Table of faults 2/3

Fault	Possible cause	Troubleshooting
Adjustment of the lying surface (back, upper leg and lower leg section) not functioning.	(1) Hand control locked. (2) Nurse keypad locked. (3) The mains plug is not plugged in or there is no power to the socket and battery pack (option) is discharged. (4) Bed taken out of service. (5) Hand control faulty. (6) Nurse keypad faulty.	(1) Unlock hand control  37. (2) Unlock nurse keypad  37. (3) Connect the plug or check the socket. Then press the green button on the mains isolation  32, and then press any hand control function. (4) Press the green button on the mains isolation  32, and then press any hand control function. (5) Replace hand control. (6) Replace nurse keypad.
The bed cannot be adjusted in height.	(1) Hand control locked. (2) Nurse keypad locked. (3) The mains plug is not plugged in or there is no power to the socket and battery pack (option) is discharged. (4) Bed taken out of service.	(1) Unlock hand control  37. (2) Unlock nurse keypad  37. (3) Connect the plug or check the socket. Then press the green button on the mains isolation  32, and then press any hand control function. (4) Press the green button on the mains isolation  32, and then press any hand control function.

 *Continued on next page.*

Troubleshooting | Table of faults 3/3

Fault	Possible cause	Troubleshooting
The bed cannot be adjusted in height.	(5) Hand control faulty. (6) Nurse keypad faulty.	(5) Replace hand control. (6) Replace nurse keypad.

Troubleshooting | Service points

If necessary, please seek assistance from the relevant contact at your nearest Völker sales organisation. You will receive all the information you need for comprehensive service promptly.

Appendix

The **Appendix** section contains the technical specifications and classifications, details on the service life and disposal of the equipment and links to the manufacturers' declarations and forms found in the appendix.

Konformitätserklärung

Anhang VII
EU-Richtlinie 93/42/EWG

Der Unterzeichnete

Völker GmbH
Wullener Feld 79
58454 Witten

mit einer Fertigungsstätte unter der Adresse:
Völker GmbH
Ahornstraße 4
09661 Hainichen

bestätigt, dass die nachfolgend bezeichneten Produkte in der von uns in Verkehr gebrachten Ausführung die grundlegenden Anforderungen des Anhangs I der EU-Richtlinie 93/42/EWG erfüllen. Es wurden die folgenden Normen angewendet :

DIN EN 60601-1:1990+A1:1993+A2:1995,
DIN EN 60601-1-2:2007-12,
DIN EN 60601-2-52:2010-12
(Anwendungen der relevanten Teile),

Declaration of conformity

Appendix VII
EU Directive 93/42/EEC

The signatory

Völker GmbH
Wullener Feld 79
58454 Witten/Germany

with a manufacturing side at:
Völker GmbH
Ahornstraße 4
09661 Hainichen/Germany

confirms that the products described below and in the form distributed by ourselves meet the basic requirements of Appendix I of EU Directive 93/42/EEC. The following standards are applied :

DIN EN 60601-1:1990+A1:1993+A2:1995,
DIN EN 60601-1-2:2007-12,
DIN EN 60601-2-52: 2010-12 (applicable parts only),

Déclaration de conformité

Annexe VII
Directive EU 93/42/CEE

La soussignée

Völker GmbH
Wullener Feld 79
58454 Witten/Allemagne

avec un site de production à:
Völker GmbH
Ahornstraße 4
09661 Hainichen/Allemagne

confirme que les produits spécifiques ci-dessous sont conformes, dans le modèle mis en circulation, aux exigences fondamentales de L'annexe L de la directive européenne 93/42/CEE. Les standards suivants sont appliqués :

DIN EN 60601-1:1990+A1:1993+A2:1995,
DIN EN 60601-1-2:2007-12,
DIN EN 60601-2-52 : 2010-12
(en partie applicable),

CONTENTS

Symbols used  64

Technical data  65

Classification  67

Type label  68

Service life / disposal  70

Manufacturer's declarations, forms, electronic instructions for use  71

Appendix | Symbols used



Warning symbols

Information marked with this symbol must always be read and strictly observed!



Warning about the risk of crushing and entrapment!



Note the information in the instructions for use!

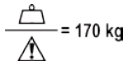

Safe working load 170 kg

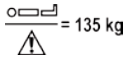

Max. permitted weight of the occupant/patient
135 kg (in application environments 3, 4 and 5)
9



Direct current



Alternating current



Protection class II device, protection-insulated



Type B application part as per DIN EN 60601-1



The product satisfies the fundamental requirements of Appendix 1 of EU Directive 93/42/EEC.



The product must be disposed of in accordance with EU Directive 2002/96 pertaining to old electrical and electronic equipment.

Appendix | Technical data (standard design) 1/2

The details marked below with * are dependent on the length, width or model of the bed. The values specified relate to model 5380 in Design S.

External dimensions (W x L)	
for lying surface 90 x 200 cm *	approx. 98 x 210 cm
for lying surface 90 x 220 cm *	approx. 98 x 230 cm
for lying surface 100 x 200 cm *	approx. 108 x 210 cm
for lying surface 100 x 220 cm *	approx. 108 x 230 cm
Height of the lower edge of lying surface frame (min./max.) *	approx. 16 cm / 71 cm
Height of the upper edge of the lying surface (min./max.)*	approx. 23 cm / 78 cm
Height of upper edge of head and foot section (min./max.) *	approx. 61.5 cm / 116.5 cm
Lying surface (4-part) *	approx. 90 x 200/220 cm approx. 100 x 200/220 cm
Volumetric weight of the mattress material	40 - 50 kg/m ³
Unladen weight *	approx. 133 kg



Safe working load for the bed	170 kg	
Max. occupant/patient weight  9	<u>in applica- tion environ- ment 1, 2</u>	<u>in applica- tion environ- ment 3, 4, 5</u>
5380	105 kg	135 kg
5380 K	105 kg	135 kg
Safe working load for the trapeze bar holder	75 kg	
Safe working load for drip stands	2 kg / hook	
Castors	2 x head end: Ø 80 mm 4 x foot end: Ø 100 mm	
Max. load on castors	100 kg (dynamic)	

Appendix | Technical data (standard design) 2/2

Mains voltage	AC 230 V (EU version) AC 240 V (UK version) AC 115 V (US version)
Nominal power	173 VA
Nominal frequency	50 Hz (EU-, UK version) 60 Hz (US version)
Primary fuse	Thermal circuit breaker 110°C/ Thermal fuse 130 °C (EU, UK version) Thermal circuit breaker 70°C/ Thermal fuse 115 °C (US version)
Hand control fuse	Type: Polyswitch RXE 025
Lying surface motor fuse	Type: Polyswitch, solid, 2.5 A
Lifting motor fuse	Type: Polyswitch, solid, 3.75 A per motor
Battery pack (option)	Type: 4 x 6 V block battery (lead gel) 1.2 Ah
Battery	Type: Type 9 V block bat- tery (alkali manganese, commercially available)
Operating temperature range	+ 10 °C to + 40 °C

Transport / storage tempera- ture range	- 20 °C to + 60 °C
Air humidity	30 % to 75 % rel.
Atmosphere range	700 hPa to 1060 hPa
Operating volume	54 dB(A)

Appendix | Classification

Protection against electric shock	Protection class II or device with internal electrical current source 
Protection type by housing as per EN 60529	IPX4 not suitable for cleaning in automatic washing systems
Degree of protection of the applied part against electric shock as per DIN EN 60601-1	Type B 
Degree of protection against explosive substances and mixtures	The bed is not protected against explosion and should not be used in an environment in which flammable anaesthetics or flammable cleaning agents are present (see brochure from accident prevention organisation ZH 1/200)
Grouping/Classification as per 93/42/EEC Appendix IX	Class I

Mode	Int. 1 min/10 min On-time max. 1 Min. Off-time 10 Min.
Technical check	1x yearly

Appendix | Type label 1/2

Type specifications

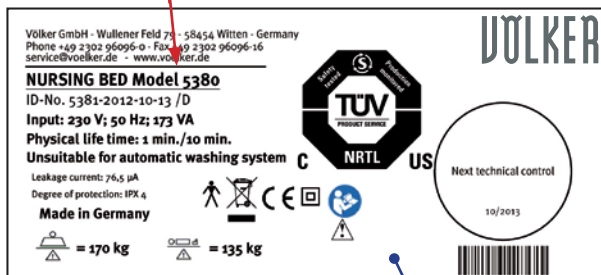

The type label is located on the inside of the head panel.

Raise the back section to read the type label.



Type specifications	Explanation
1. line	Model designation. In the example: NURSING BED model 5380
2. line	ID No. (made up as follows): 5381 = Model -2012 = Year of construction -10 = Production week (calendar week) -13 = Consecutive number D = Mains plug version (e.g. D = Germany)
3. line	Input: mains voltage; mains frequency; power consumption
4. line	Physical life time: Max. uninterrupted on-time of electric motor adjustment. In the example: 1 min/10 min This means that the bed may be operated with the electric motor without interruption for max. 1 minutes, after which a pause of 10 minutes will be necessary (protection against overheating).
5. line	Suitable for automatic washing systems. In the example: unsuitable for automatic washing systems.

Symbols used 64

Appendix | Type label 2/2

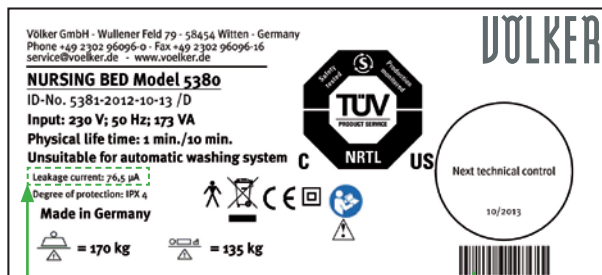

Measured values

Barcode

Measured values

1. line Leakage current in µA

The specified initial measured values were measured in accordance with EN 62353.





The barcode (code 39) contains the numeric ID No. (10 digits).

Appendix | Service life/disposal



The bed's expected service life is approx. 10 years. To ensure environmentally responsible disposal after decommissioning, please contact your responsible area sales manager.

Appendix | Manufacturer's declarations, forms, electronic instructions for use

Manufacturer's declarations

- Declaration of conformity  72
- Table 201 – Guidelines and manufacturer's declaration – Electromagnetic compatibility (6.8.3.201 a) 3))  73
- Guidelines and manufacturer's declaration – Electromagnetic compatibility (6.8.3.201 a) 6))  74
- Table 204 – Guidelines and manufacturer's declaration – Electromagnetic compatibility for all devices and systems that are not life-sustaining (6.8.3.201 b))  76
- Table 206 - Recommended protected distance between portable and mobile HF telecommunications equipment and the bed – for devices and systems that are not life-sustaining (6.8.3.201 b))  79

Forms

- Technical check of Völker hospital and healthcare beds in accordance with German standards and safety regulations incl. measurements required  80
- Spare part order  81

Electronic instructions for use

- Requirement for the use of the electronic instructions for use  82

Konformitätserklärung / Declaration of Conformity / Déclaration de conformité

Konformitätserklärung Anhang VII EU-Richtlinie 93/42/EWG Der Unterzeichnende Völker GmbH Wullener Feld 79 58454 Witten	Declaration of conformity Appendix VII EU Directive 93/42/EEC The signatory Völker GmbH Wullener Feld 79 58454 Witten/Germany	Déclaration de conformité Annexe VII Directive EU 93/42/CEE La soussignée Völker GmbH Wullener Feld 79 58454 Witten/Allemagne
mit einer Fertigungsstätte unter der Adresse: Völker GmbH Ahornstraße 4 09661 Hainichen	with a manufacturing side at: Völker GmbH Ahornstraße 4 09661 Hainichen/Germany	avec un site de production at: Völker GmbH Ahornstraße 4 09661 Hainichen/Allemagne
bestätigt, dass die nachfolgend bezeichneten Produkte in der von uns in Verkehr gebrachten Ausführung die grundlegenden Anforderungen des Anhangs I der EU-Richtlinie 93/42/EWG erfüllen. Es wurden die folgenden Normen angewendet: DIN EN 60601-1:1990+A1:1993+A2:1995, DIN EN 60601-1-2:2007-12, DIN EN 60601-2-52:2010-12 (Anwendungen der relevanten Teile).	confirms that the products described below and in the form distributed by ourselves meet the basic requirements of Appendix I of EU Directive 93/42/EEC. The following standards are applied: DIN EN 60601-1:1990+A1:1993+A2:1995, DIN EN 60601-1-2:2007-12, DIN EN 60601-2-52:2010-12 (applicable parts only),	confirme que les produits spécifiés ci-dessous sont conformes, dans le modèle mis en circulation, aux exigences fondamentales de l'annexe I de la directive européenne 93/42/CEE. Les standards suivants sont appliqués: DIN EN 60601-1:1990+A1:1993+A2:1995, DIN EN 60601-1-2:2007-12, DIN EN 60601-2-52:2010-12 (en partie applicable).
Damit sind die Anforderungen des Medizinproduktegesetzes zur Anbringung einer CE Kennzeichnung erfüllt.	The requirements of the medical products law pertaining to the display of a CE seal of approval are thereby fulfilled.	Les exigences de la loi sur les produits médicaux concernant l'apport de la marque CE sont ainsi satisfaites.
Bei einer nicht mit dem Hersteller abgestimmten Änderung des Produktes verliert diese Konformitätserklärung ihre Gültigkeit.	This declaration of conformity becomes invalid if the products are altered without the agreement of the manufacturer.	Cette déclaration de conformité est invalable en cas de modification des produits, non autorisée par le fabricant.
Bezeichnung der Produkte: Pflegebetten 5380, 5380 K, 2080, 3080, 3080 K	Description of products Type/Article No.: Nursing beds 5380, 5380 K, 2080, 3080, 3080 K	Désignation des produits Modèle/Référence: Lits médicalisés 5380, 5380 K, 2080, 3080, 3080 K
EG-Richtlinien: Richtlinie 93/42/EWG vom 14.06.1993 über Medizinprodukte (Anhang I „Grundlegende Anforderungen“). Die Produkte sind Produkte der Klasse I gemäß Anhang IX der Richtlinie 93/42/EWG vom 05.09.2007.	EU Directives: Directive 93/42/EEC of 14.06.1993 concerning medical products (Appendix I, Basic requirements). The design and construction of this product conforms to Class I (Appendix IX) Directive 93/42/EEC of 05.09.2007.	Directives européennes: Directive 93/42/CEE du 14.06.1993 sur les produits médicaux (annexe I « Exigences fondamentales »). La conception du produit est conforme à la classe I (annexe IX) Directive 93/42/CEE du 05.09.2007.

Witten, 20.02.2012

 Mitchell Tidman

Geschäftsführer / Managing Director / Gérant

Info
 You can find a
 printable version
 of this document
 on the Internet at
www.voelker.de.

**Table 201 - Guidelines and manufacturer's declaration - Electromagnetic compatibility
(6.8.3.201 a) 3))**

The bed is intended for use in the electromagnetic environment as described below. The customer or user of the bed should ensure that it is used in such an environment.

Emissions measurements	Conformity	Electromagnetic environment - guideline
HF emissions IEC 61000-3-2	Class A	The bed is suitable for use in all institutions, including residential areas and such that are directly connected to a public mains supply network that also supplies buildings intended for residential purposes.
Fluctuations in voltage / flicker IEC 61000-3-3	Conforms	
RF emissions CISPR 14 – 1	Conforms	The bed is not suitable for connection to other equipment.

Guidelines and manufacturer's declaration - Electromagnetic compatibility (6.8.3.201 a) 6))

The bed is intended for use in the electromagnetic environment as described below. The customer or user of the bed should ensure that it is used in such an environment.

Compatibility check	IEC 60601 Testing level	Conformity level	Electromagnetic environment - guideline
Discharge of static electricity (ESD) IEC 61000-4-2	± 6 kV contact discharge ± 8 kV air discharge	± 6 kV contact discharge ± 8 kV air discharge	The ground should be made of wood or concrete and be laid with ceramic tiles. If the ground is covered with synthetic material, the relative air humidity must be at least 30%.
Rapid transient electrical disturbance / bursts IEC 61000-4-4	± 2 kV for voltage supply ± 1 kV for input and output cables	± 2 kV for voltage supply Not applicable	The quality of the voltage supply should be commensurate with a typical commercial or hospital environment.
Surge voltages IEC 61000-4-5	± 1 kV series mode voltage ± 2 kV common-mode voltage	± 1 kV series mode voltage Not applicable	The quality of the voltage supply should be commensurate with a typical commercial or hospital environment.

 *Continued on next page.*

Compatibility check	IEC 60601 Testing level	Conformity level	Electromagnetic environment - guideline
Voltage drops, short interruptions and voltage fluctuations in the mains voltage supply IEC 61000-4-11	<p>< 5 % U_T (>95 % voltage peaks in U_T) for 0.5 cycles</p> <p>40 % U_T (60 % dip in U_T) for 5 cycles</p> <p>70 % U_T (30 % dip in U_T) for 25 cycles</p> <p>< 5 % U_T (>95 % dip in U_T) for 5 sec</p>	<p>< 5 % U_T (>95 % voltage peaks in U_T) for 0.5 cycles</p> <p>40 % U_T (60 % dip in U_T) for 5 cycles</p> <p>70 % U_T (30 % dip in U_T) for 25 cycles</p> <p>< 5 % U_T (>95 % dip in U_T) for 5 sec</p>	<p>The quality of the voltage supply should be commensurate with a typical commercial or hospital environment.</p> <p>If the user requires continued function from the bed when interruptions in the power supply occur, it is recommended that the bed be powered via an uninterruptible power supply or a battery.</p>
Magnetic field at supply frequency (50/60 Hz) IEC 61000-4-8	3 A/m	3 A/m	Magnetic fields at mains frequency should correspond to the typical values present in commercial and hospital environments.
Remark 1: U_T is the mains AC voltage before the testing level is applied.			

**Table 204 – Guidelines and manufacturer's declaration – Electromagnetic compatibility
for all devices and systems that are not life-sustaining (6.8.3.201 b))**

The bed is intended for use in the electromagnetic environment as described below. The customer or user of the bed should ensure that it is used in such an environment.

Compatibility check	IEC 60601 Testing level	Conformity level	Electromagnetic environment - guideline
Conducted HF disturbances IEC 61000-4-6	3 Vrms 150 kHz to 80 MHz	3 V	

 *Continued on next page.*

Compatibility check	IEC 60601 Testing level	Conformity level	Electromagnetic environment - guideline
Radiated HF disturbances IEC 61000-4-3	3 V/m 80 MHz to 2.5 GHz	3 V/m	<p>Portable and mobile radio equipment should not be used any closer to the bed, or their cables, than the recommended protective distance which is calculated based on the equation applicable for the transmission frequency.</p> <p>Recommended protective distance</p> <p>$d = 1.17\sqrt{P}$ 150 kHz to 80 MHz</p> <p>$d = 1.17\sqrt{P}$ 80 MHz to 800 MHz</p> <p>$d = 2.33\sqrt{P}$ 800 MHz to 2.5 GHz</p> <p>Where P is the rated output of the transmitter in Watts (W) as specified by the transmitter manufacturer and d is the recommended protective distance in metres (m).</p> <p>The field strength of stationary radio transmitters should be less than the conformity level^b at all frequencies, as verified by an on-site test^a.</p> <p>Disturbance is possible in the environment of equipment that bears the following label.</p> 

 Continued on next page.

Remark 1: At 80 MHz and 800 MHz, the higher frequency range applies.

Remark 2: These guidelines may not be applicable in all cases. The spread of electromagnetic parameters is influenced by the absorption and reflection of buildings, objects and people.

^a The field strength of stationary transmitters, such as base stations of cordless telephones and mobile land radio, amateur radio stations, AM and FM radio and TV stations cannot be quantified in theory in advance accurately. To determine the electromagnetic environment in relation to a stationary transmitter, a study of the site should be considered. If the measured field strength at the site where the bed is used exceeds the conformity levels stated above, the bed should be observed to ensure that it functions correctly. If unusual features are observed, additional measures may be required, such as modified alignment or a different location for the bed.

^b In the frequency range from 150 kHz to 80 MHz, the field strength should be less than 3 V/m.

Table 206 - Recommended protective distance between portable and mobile HF telecommunications equipment and the bed – for devices and systems that are not life-sustaining (6.8.3.201 b))

The bed is intended for operation in an electromagnetic environment in which HF disturbances are controlled. The customer or user of the bed can help to avoid electromagnetic disturbances by respecting the minimum distance between portable and mobile HF telecommunications equipment (transmitters) and the bed. The recommended minimum distance d is dependent on the maximum power output of the communication device (see below).

Rate output of the transmitter W	Protective distance according to the frequency of the transmitter m		
	150 kHz to 80 MHz $d = 1.17 \sqrt{P}$	80 MHz to 800 MHz $d = 1.17 \sqrt{P}$	800 MHz to 2.5 GHz $d = 2.33 \sqrt{P}$
0.01	0.12	0.12	0.23
0.1	0.37	0.37	0.74
1	1.17	1.17	2.33
10	3.69	3.69	7.38
100	11.67	11.67	23.33

For transmitters whose maximum rated output is not specified in the table above, the recommended protective distance d in metres (m) can be calculated using the equation in the column that features P as the maximum power output of the transmitter in Watts (W) as defined by the transmitter manufacturer.

Remark 1: At 80 MHz and 800 MHz, the higher frequency range applies.

Remark 2: These guidelines may not be applicable in all cases. The spread of electromagnetic parameters is influenced by the absorption and reflection of buildings, objects and people.

Requirement for using the electronic instructions for use

In order to open the electronic version of these operating instructions (PDF file), you must have Adobe Reader 7.0.5 or later (or the corresponding Adobe Acrobat version) installed on your PC.

Adobe Reader is available for nearly all operating systems. The newest version can be obtained free of charge by download from www.adobe.de/products/acrobat/readstep2.html .

The electronic version of these instructions for use may be found on the Internet at www.voelker.de.

Trademarks

Adobe, Acrobat and Reader are protected or registered trademarks of Adobe Systems Incorporated.

Windows is a registered trademark of the Microsoft Corporation.

VÖLKER

Völker GmbH

Wullener Feld 79 · 58454 Witten/Germany

Telephone +49 2302 960 96-0

Fax +49 2302 960 96-16

www.voelker.de · info@voelker.de