

Völker Hospital Bed

User's Manual

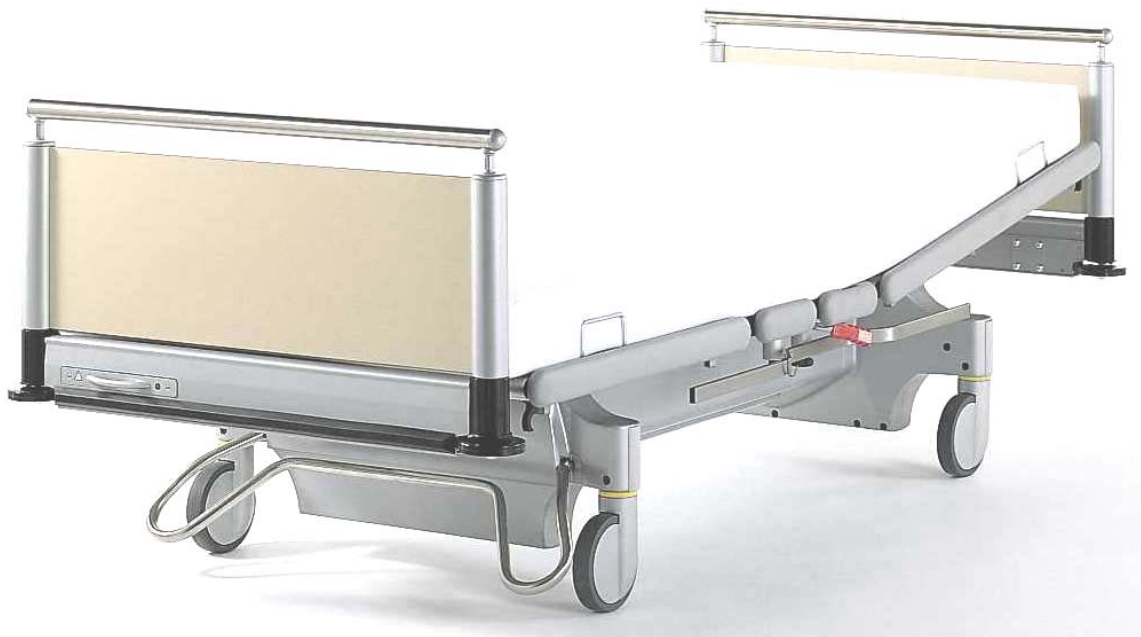

Model S 960-1

Edition: 2002-12-C

© **Völker AG** 2002

Völker AG

Wullener Feld 79
58454 Witten
FR GERMANY

Tel.: ++49-(0)2302-96096-0
Fax: ++49-(0)2302- 96096-16
Mail: info@voelker.de
Internet: www.voelker.de

All rights reserved. Reproduction and copying in whole or in part prohibited.
We reserve the right to carry out changes by reason of technical developments.
The contents of this document are subject to change without prior notice.
Customers are advised to consult their sales representative before placing an order.

20020116

G - 16

Foreword

We congratulate you on your choice of a Völker hospital bed and would like to thank you for your confidence in our company and its products.

Before purchase, we are sure that you received detailed information and advice that convinced you of the many benefits of our hospital beds – benefits that in this configuration are truly unique.

The fact that a Völker hospital bed – in spite of its many functional features and technical refinements – does not look like a piece of sterile institutional equipment undoubtedly made your decision to purchase all the easier.

This user's manual is intended to provide you with information on the technical features of Völker S 960-1 to help you to get the most out of its many functions.



Michael Hüppe

Chairman
Völker AG

Contents

1.	GENERAL REMARKS	6
1.1.	Copyright	6
1.2.	Warranty and liability	6
2.	SAFETY REGULATIONS	7
2.1.	German medical products law (MPG) §22, Section 1	7
2.2.	Intended use	7
2.3.	Incorrect use	7
2.4.	General safety instructions.....	9
2.5.	Electromagnetic/-static interference	10
2.6.	Before using the bed for the first time.....	10
2.7.	Checking the operational safety and condition of the beds	10
2.8.	Position of the hospital bed.....	11
2.9.	Four-castor central braking system.....	11
2.10.	Height adjustment	11
2.11.	Safety frames - Danger of entrapment.....	11
2.12.	Cleaning and disinfection	11
2.13.	Service and maintenance.....	12
3.	DEFINITIONS AND TECHNICAL DESCRIPTION	13
3.1.	Definitions	13
3.2.	Technical description.....	14
4.	EXPLANATORY NOTES FOR CARERS	20
5.	REVIEW: TYPES OF PATIENT POSITIONING.....	21
6.	OPERATIONAL UNITS.....	22
6.1.	General operating instructions.....	22
6.1.1.	Safety class	22
6.1.2.	Operating interval.....	22
6.1.3.	Batteries.....	22
6.1.4.	Built-in safety cut-out	22
6.2.	Review: Bed functions	23
6.3.	Putting bed into service for the first time (initiation)	24
6.3.1.	Location.....	24
6.3.2.	Mechanical initiation	24
6.3.3.	Electrical initiation.....	25
6.4.	Operation with handset	27
6.5.	Operation of electrical functional modes	28
6.5.1.	Adjustment of back section	29
6.5.2.	Adjustment of upper leg section.....	30
6.5.3.	Adjustment of lower leg section (raised lower leg)	30
6.5.4.	Height adjustment of bed	32
6.5.5.	Trendelenburg and reverse trendelenburg positioning	34

6.5.6.	Sitting position (cardiac)	35
6.5.7.	Voltage compensator cable connection.....	36
6.6.	Operation of mechanical functions	37
6.6.1.	Four-castor central braking with total & directional locking facility	37
6.6.2.	Mechanical fast release of back section, CPR function	38
6.6.3.	Use of safety frames	39
6.6.3.1	Operation of safety frames	39
6.6.3.2	General warning on the use of safety frames.....	43
6.6.4.	Removal of headboard and footboard	45
6.6.5.	Wall buffers	45
6.7.	Operation with carers' keyboard	46
6.7.1.	Description of keys	46
6.7.2.	Menu	47
6.7.2.1	Limit of travel.....	48
6.7.2.2	Date.....	49
6.7.2.3	Time	50
6.7.3.	Language.....	50
6.7.4.	RESET	51
6.7.5.	Eco-mode (power-saver).....	51
6.7.6.	Reinstating ground level state (booting)	52
6.7.7.	Error message from control	52
6.7.8.	Battery level indicator	54
6.7.9.	Battery saver	55
6.7.10.	Manual functions.....	56
6.7.11.	Automatic functions	56
6.7.12.	Limitation of current	57
6.7.13.	Deactivating functions.....	57
6.7.13.1	Deactivating motional functions.....	57
6.7.13.2	Deactivating all functions, incl. emergency functions	57
6.7.13.3	Deactivating handset.....	58
6.7.13.4	Deactivating handset comfort key	59
6.7.14.	Miscellaneous	60
6.8.	Automatic functions (from 26 June 2002)	60
6.8.1.	Description of automation functions	61
7.	ACCESSORIES	63
8.	FUNCTIONAL TEST	64
9.	CLEANING AND DISINFECTION	68
10.	MAINTENANCE INSTRUCTIONS	71
11.	TECHNICAL SPECIFICATIONS	72
11.1.	Technical data.....	72
11.2.	Classification	73
11.3.	Meaning of symbols	74
11.4.	Dimensions, S 960-1 hospital bed	77

General remarks

You have purchased a Völker hospital bed developed and manufactured in accordance with the current state of technical knowledge.

Völker hospital beds fully meet all safety and operational requirements. They are tested in accordance with international standards and carry the CE Seal. This confirms that they fulfil the safety requirements relating to medical products.

Please read the basic safety instructions in Chapter 2. Please also note the further instructions given on subsequent pages, particularly with a view to possible warranty claims.



This user's manual is intended to give you and your staff practical information and tips on the safe and correct use of the S 960-1 hospital bed.

Anybody concerned with putting the bed into service for the first time, or with its operation and maintenance, must read and strictly obey this user's manual, paying close attention to the safety requirements.

To avoid faulty handling and to ensure the trouble-free operation of the S 960-1 hospital bed, this documentation must be available to carers and/or patients at all times.

Copyright

This user's manual may only be made available to third parties with the express written agreement of Völker AG. All documentation is subject to copyright. Unless expressly permitted, the transfer and duplication of documentation, either whole or in part, as well as its exploitation and/or publication, are forbidden. Infringements of copyright are punishable in law and oblige transgressors to pay damages. The company reserves the right to exercise all its prerogatives in commercial law.

Warranty and liability

We accept liability for possible errors and omissions within the terms of warranty laid down in the main contract. Claims for damages – from whatever legal ground they may be held to derive – are expressly excluded.

We reserve the right to make technical changes to the hospital beds described in this user's manual in accordance with technical developments.

We accept no liability whatsoever for damage and/or disruption caused by faulty handling and/or a failure to follow the instructions in this user's manual (see also 4).

1. Safety regulations

These regulations must be read and strictly obeyed!

1.1. German medical products law (MPG) §22, Section 1



The hospital bed may only be put into service, operated and used **a)** as intended by the manufacturer, **b)** in accordance with the provisions of the medical products law (MPG) and its enacted statutory instruments, **c)** with due regard to good technical practice and **d)** in accordance with safety and accident-prevention regulations. ***On no account*** may the bed be used in a faulty condition that could endanger patients, carers or others.

The hospital bed may only be operated by those able to guarantee its correct handling by virtue of their professional qualifications, knowledge and/or experience.

1.2. Intended use



Völker S 960-1 hospital beds are intended to be used solely for the care of patients in patients' rooms in hospitals, clinics and/or nursing institutions.

The care of patients under 12 in the S 960-1 hospital bed is permitted only when accompanied by appropriate safety measures, eg the use of protective safety frame covers.

Any use of Völker hospital beds that deviates in any way whatsoever from this intended use is expressly excluded from possible liability claims.

1.3. Incorrect use



The incorrect use of the bed can be a source of danger. Examples of incorrect use are:

- incorrect operation of electrical functions and unsupervised positioning,
- use of hospital bed with children under 12,
- operation of hospital bed by patients without prior instruction,
- simultaneous operation of electrical functions by different people,
- constant operation of keyboard ('piano playing'),
- connecting electrical devices to bed which are not suitable for the purpose intended (subject to management's duty of care),
- moving bed by pulling on cable,
- disconnecting electric plugs by pulling on cable,
- using bed on sloping surfaces with gradients in excess of 10° (bed brakes designed for a maximum gradient of 10°),
- trying to move bed with brakes applied,

-
- transporting patients by towing or pushing bed with a vehicle,
 - using bed with loads in excess of specified maximum safe working load.

1.4. General safety instructions



CAUTION!

Refer to user's manual!
Please read safety instructions!

WARNING! – Serious injury can be caused when moving powered parts of the bed. Make absolutely sure that there are no parts of the body poking through the safety frames during electrical operation. Ensure without fail that there are no people, pets or objects beneath the bed.

WARNING! – Increased safety measures are necessary when the bed is being used ...

1. ... by a child under 12 years of age,
2. ... by a person with reduced mental faculties,
3. ... for psychiatric purposes.

WARNING! – Automatic mode should not be selected when the bed is being used ...

1. ... by a child under 12 years of age,
2. ... by a person with reduced mental faculties,
3. ... for psychiatric purposes.

WARNING! – In order to avoid falls, always return the bed to lowest position after each use of the adjustment functions. Make absolutely sure that
a) the bed is in lowest position before getting into or out of it, and
b) the brakes are applied.

WARNING! – Safety frames only mark the limits of the bed. Other appropriate measures must be used to restrain patients.

WARNING! – Children under 12 and people with reduced mental faculties may only occupy Völker beds when the safety frames are covered by protective covers. Risk of injury. Refer to user's manual.

WARNING! – In order to minimise risk of injury, the following permitted mattress sizes must be strictly observed. If you are not using Völker mattresses, please contact your Völker authorised dealer.

Mattress-size

88 x 210 x 12 cm
88x 200 x 12 cm
88 x 197x 15 cm
88 x 207 x 15 cm

Mattress-frame size

90 x 210 cm
90 x 200 cm
90x 200 cm
90 x 210 cm

WARNING!

Make sure that the cable does not get caught in moving parts.

WARNING!

- > Only use original spare parts for repairs.
- > Only repair bed when it is in lowest position.
- > Pull out power plug before repair or cleaning.

Refer to user's manual and maintenance manual for further safety instructions.

1.5. Electromagnetic/-static interference



To ensure protection against electromagnetic and electrostatic interference (EMV), the S 960-1 hospital bed fulfils all the requirements of the relevant sections of the German medical products law (MPG).

Basis of testing for:

- high-frequency interference: EN 60601-1-2:1993
- limiting values according to: EN 55011 Group 1, Class B:1998
- limiting values according to: EN 55014:1993
- resistance to jamming: EN 60601-1-2:1993

1.6. Before using the bed for the first time



Before the bed is put into service for the first time, this user's manual must be closely read by all those responsible for nursing care.

Before the bed is put into service for the first time, it is absolutely essential to carry out a functional test as described in Chapter 8.

Before first use, carers must receive detailed instructions in the operation of the bed. In addition, carers must be made fully aware of potential dangers that can arise in spite of the correct operation of the bed (see Chapter 4).

1.7. Checking the operational safety and condition of the bed



Before putting the bed into service, it is essential to make absolutely sure that it is in good working condition and safe to use. This test must not only be carried out before first use, but continuously throughout the service life of the bed. If necessary, the bed must be tested daily or after each shift to ensure that its use does not endanger anybody. To reduce maintenance to a necessary minimum, the bed should be cleaned, disinfected and tested as soon as possible after each use so that it can be used again without delay or risk (see Chapter 8, Functional test). Please note that preparation in a cleaning plant offends against this principle (see Chapter 9). In cases of malfunctioning, it may be necessary to transfer the patient to another bed.

1.8. Position of the hospital bed – Danger of falling out of bed



In the case of unsupervised patients, we recommend that the bed is put into its lowest position to minimise the risk of injury due to falling out of bed. In other cases, it should be put at a height proportionate to the size of the patient.

1.9. Four-caster central braking system – Caution! Risk of accident



Unless in transport, the brakes must always be applied so that patients can use the bed as a support when accessing or exiting it. Serious falls can result through an unbraked bed rolling away. After applying the brakes, check that the bed is really immobile, ie that the brakes are fully applied to all four castors.

Height adjustment – Risk of entrapment between bed-frame and chassis



When adjusting the bed, make absolutely sure that no limbs, bedding or other objects are situated between the bed-frame and the chassis.

1.10. Safety frames – Risk of entrapment



In the case of patients whose physical or mental state may be felt to call for the use of safety frames to protect them from falling out of bed, the following safety measures **must be observed at all times**:

1. Safety frames may be operated **only** by carers instructed in their use.
2. Make sure safety frames – or elements of them – are either fully raised and locked or fully lowered.
3. During the electrical adjustment of the mattress-frame, make sure that the patient is not touching the safety frames. Also make absolutely sure that no limbs are poking through the frames.
4. If the safety frames are being used to protect a child or a person whose physical state may make their use appropriate, then make sure that the handset is out of reach. We also recommend the use of safety frame covers.



Failure by carers to obey these safety rules may cause hæmatoma or other injury to hands, knees, fingers, feet, shins and hips through entrapment.

1.11. Cleaning and disinfection



Risks can arise through the incorrect cleaning and/or disinfection of the bed.

1.12. Service and maintenance



The S 960-1 bed requires very little maintenance. All moving parts of the lifting gear, mattress-frame drives and safety frames are permanently lubricated during manufacture. None of these parts need relubrication when the bed is correctly used and cleaned. The manufacturer assumes, however, that beds are regularly inspected and damage such as worn parts, loose screws or fractures are immediately put right. For further information, please see the maintenance section of this user's manual.

2. Definitions and technical description

2.1. Definitions

In the following text, "Völker" means "Völker AG".

In the following text, "Völker bed" or "Völker hospital bed" means the S 960-1 hospital bed.

In the following text, "patient" means a person who is in the bed, or accessing or exiting it.

"Due care" means that all activities involving the bed in any way must guarantee the safety and freedom from harm of patients, carers and others.

In the following pages, the bed and its operation are explained and described with the help of photos and drawings.

Exceptionally important information in the technical description is marked by this symbol:



= **Warning**

This information is to be read and obeyed without fail.

Technical description

Dimensions: Mattress-frame: 90 cm x 210 cm
Height adjustment: 40 cm – 80 cm depending on castors used

Exterior dimensions: Length: 227 cm
Width: 98 cm

Net weight of bed: 146 kg

Safety: Classification according to MDD 93/42/EWG (MPG) Class 1.
Electrical protection: Safety category II/type B (body).
Appliance with internal energy storage device 24V.

Designed and constructed according to the latest definitive guidelines and harmonised standards; with CE Declaration of Conformity; complies with following specification:
European guideline 93/42/EWG, Appendix 1 (MPG) for medical products, with standards conformity according to:

DIN EN 60601-1 (VDE 0750 Teil 1):1996-03 – Electric medical appliances, Part I : General directive on safety (German version EN 60601-1: 1990+A1: 1993+A2: 1995; IEC 601-1:1988+A1:1991+A2:1995);

DIN EN 60601-1-2 (VDE 0750 Part 1-2): 1994-09 – Electromagnetic compatibility (EMV) (German version EN 60601-1-2:1993; IEC 601-1-2:1993)

DIN EN 60601-1-4 (VDE 0750 Part 1-4): 1997-07 – Programmable electric medical systems (German version EN 60601-1-4:1996; IEC 601-1-4:1996);

DIN EN 60601-2-38 (VDE 0750 Part 2-38):1998-01 – Special directive on the safety of electrically-powered hospital beds (German version EN 60601-2-38:1996; IEC 60601-2-38:1996).

Construction: IP X5, optional IP X6. Entire construction low-maintenance; all functions and control encased; chassis corrosion-free aluminium, impact-resistant, burnt-enamel powder-coated according to Völker colour card. All other assemblies aluminium, special plastic or equivalent material; headboard, footboard and castors according to Völker colour card. Frame with sturdy fenders; 4 horizontal wall buffer wheels at each corner, 2 vertical wall buffer wheels at head end. Trapeze pole fixing location; standardised, variable full-length slide-bar for accessories on both sides of bed beneath mattress-frame.

Chassis: The entire lifting gear and carriage is housed in a sealed, distortion-resistant metal casing according to IP X5. Floor-clearance of 40 cm provides

adequate leg room for carers and space for (eg) bed jacks. Smooth, uncluttered surfaces without plastic snap-in covers make for easy and effective cleaning.

Distortion-free aluminium construction;

2 18 V motors, lifting capacity 350 kg;

electrically-powered fourfold telescopic height adjustment from ca. 40 cm to ca. 80 cm, depending on choice of castors;

lateral synchronisation control for automatic correction of deviations in parallel operation of lifting gear and when returning from trendelenburg and/or reverse trendelenburg positioning; horizontal or vertical deviation is also less than 10 mm when carrying out reanimation or ergotherapeutic procedures.

Trendelenburg/reverse trendelenburg to a max. 14°/12°; comfortable sitting position selectable at any height via carers' keyboard.

150 mm single castors with sealed, permanently-lubricated bearings, increased fracture-resistance even under heavy diagonally-exerted loads; streak-free tyres electrically conductive and easily removable for cleaning;

4-castor central braking system operated via brake-bar at foot of bed to block or release castors. Straight-ahead/track setting of one castor at head or foot of bed as required by care services, also via brake bar.

Mattress-frame: Four-section aluminium-profile mattress-frame with removable inlays for easy cleaning and drying (antistatic, chemical-resistant and UV-stable), according to recommendations of German Professional Nursing Association (GPNA). All mattress-frame sections interconnected and electrically conductive, voltage compensator socket on headend cross-member. Fixings for securing mattress on each side of movable sections.

Electrical adjustment of all mattress-frame positions via three separate motors; back section adjustable to 75°; automatic back section length compensation according to recommendations of GPNA; mattress-frame design according to recommendations of GPNA; to protect patients, minimum angle of back and upper leg sections 90°; electrical adjustment of cardiac, comfortable-sitting and horizontal lower leg positions; manually-operated emergency release of back section (CPR), cushioning mechanism for jerk-free descent.

Quick removal of headboard/footboard by means of fast-release fixing; electrical trendelenburg/reverse trendelenburg positioning via carers' keyboard, LED display for optimal adjustment. Four safety frame elements integrated into mattress-frame, horizontally extended also usable as depository for bedding and as support for special therapeutic positions, when raised suitable for use as support when accessing or exiting the bed.

A total of three drives is available for mattress-frame positioning, ie for back, upper leg and lower leg sections. Motors in sealed casings below central bearer. Max. standard preset back rest angle 75°.

Easy access to drives for servicing and safety checks.

Bent-knee position (comfortable sitting position) and horizontal lower leg position selectable via carers' keyboard and patient's handset; during adjustment to horizontal lower leg position, simultaneous automatic

repositioning of leg section. Full horizontal lower leg position possible by putting upper leg section at 75°.

Mattress displacement device according to GPNA:

The mattress displacement device or length compensator automatically shifts the fulcrum of the back section 15 cm backwards when it is being raised. This stops patients sliding down the bed and concertinaing against the footboard, especially when both back and leg sections are being adjusted simultaneously. The compensator creates a kinæsthetic space that stimulates patient mobility.

Fast-release facility:

The back section can be rapidly lowered (CPR) as required simply by releasing the retaining mechanism on the mattress-frame. The facility is fitted with a cushioning device to ensure jerk-free descent. No resetting is needed to reinstate normal back section operation after fast release.

Safety frames:

The S 960-1 is equipped with split safety frames on both sides of the bed that are fully integrated into the mattress-frame. When raised, they both protect the patient and serve as a support when accessing or exiting the bed. When not in use, they are pushed out of sight beneath the mattress-frame. This facilitates the unobstructed fitting of accessories and the use of a bed-jack even when the bed is in lowest position. During mattress-frame adjustment, the safety frames are repositioned automatically. To use, pull the safety frames horizontally out of their locations. To protect the patient, they are then raised either singly or together and locked into position. Complete patient protection is achieved by raising all four safety frame. Thanks to their exceptional stability, they can also be used as a depository for bedding or as support for special therapeutic positioning, eg physiotherapy. This stability also stimulates patient mobility by providing reliable support when sitting up and exiting the bed. As in the case of many S 960-1 functional features, here too the variety of possible configurations pays off. Hence the back section can be used to help the patient sit up, and the telescopic jack to put the bed at the ideal individual height for exiting it. As an option, the height of the safety frames can be increased by 12 cm, eg when using special mattresses. In this way, the minimum required height of 22 cm between mattress and the upper edge of safety frames can always be maintained. During transport, the safety frames – in whatever position – act as robust anti-impact side-fenders. In the case of the S 960-1, this avoids the usual damage to door-frames or to the safety frames themselves.

Lengthening the bed:

An extension piece mounted on telescopic slides enables the bed to be lengthened by 20 cm without removing the footboard (optional). The extension piece is securely fixed to the lower leg section of the mattress-frame and is simply pulled out of its location and folded up, as required.

Fast removal of head- and footboard:

The head- and footboard can be removed as required by means of a fast-release fixing built into the bed-frame. Easy handling at all times is ensured by the use of plastic connectors with an exceptionally long service life. As the connectors are not subject to crevice corrosion, they do not split and hence tend to clamp even after being washed many times.

Fixings for trapeze pole and drip-feed stands:

Push-in sleeves for trapeze poles and drip-feed stands are provided on the outside of the headend of the bed.

Fixings for accessories and therapeutic appliances:

Adapters fitted to the full-length slide bars on each side of the bed accept therapeutic appliances and care accessories. These can be positioned as required simply by pushing them back and forth along the slide bar. Easy positioning is guaranteed independently of bed height and safety frame configuration.

Wall buffer wheels:

In addition to the safety frames acting as side-fenders during transport, there are also horizontal buffer wheels on all corners of the bed and two further vertical buffer wheels at the headend.

Accessories: Völker offers a wide range of accessories for its beds.

You will find the complete range in our hospital accessories brochure.

Electrics and**control:**

Processor control, integrated energy storage device (battery), all functions operable without mains power supply, 230 V mains connection on battery charger, from there and within bed safe low voltage (24 V) – no electrosmog.

Carers' keyboard with all mattress-frame positions and height adjustment, plus trendelenburg/reverse trendelenburg function, activation/deactivation of patient's handset functions, including graphic display. Functions that stimulate the autonomous mobility of patients, ie height adjustment and mattress-frame positioning, can be selected by patients themselves via separate handset (unbreakable; IP X5 as standard or IP X6 for decontamination plants).

Handset for patients with the following functions:

- Back section up/down
- Upper leg section up/down
- Lower leg section up/down
- Height adjustment up/down
- Comfortable sitting position

Handset can be mounted to right or left, as required; an optional handset connection is also available on safety frame.

Operational readiness independently of mains supply is ensured by means of a rechargeable battery. An integrated power-saver (eco-mode) means that the bed remains operational over long periods out of service. In normal operation, the bed can be used for about 2 days with a fully-charged battery. When used as instructed, the service life of the batteries is at least 5 years. Spent batteries are returned to Völker for recycling.

The use of an external 400 mA charger and an internal energy storage device ensures that only safe low voltage current flows from the battery charger (in the socket) onwards. The bed is fitted with an infrared port for maintenance purposes

Cleaning:

If required, a version of the bed can be supplied that is suitable for cleaning in decontamination plants. Follow the recommendations in brochure ZH 1/200 to ensure a long service life and functional efficiency.

Maintenance

and care: Uncluttered surfaces and encased working parts make the S 960-1 exceptionally easy to clean. It is suitable for cleaning by spraying and wiping with commercial disinfectants and cleaning agents. Follow the recommendations in brochure ZH 1/200.
 All sub-assemblies are in stainless steel and hence require little maintenance. Inspection checks are only necessary at 12-month intervals. Bar-code and inventory number for technical inspections can be integrated. We also run training sessions for in-house technical staff, if required.

Warranty: 2 years warranty on construction and working assemblies.

Ecological

data: Fitted with a device (24 V safe low voltage, internal energy storage device) to hinder the formation of electrosmog.
 All packing materials are removed on delivery and taken back free of charge. We also guarantee to take back the bed itself for ecologically-appropriate utilisation/disposal.

Service life of hospital beds:

With the exception of parts subject to wear and tear, eg castors and electronic components, the bed has a service life of about 12 years providing that it is used, cleaned, serviced and repaired as instructed. Cleaning and/or disinfection in mechanical plants can reduce the above service life, depending on frequency.

Methods of cleaning

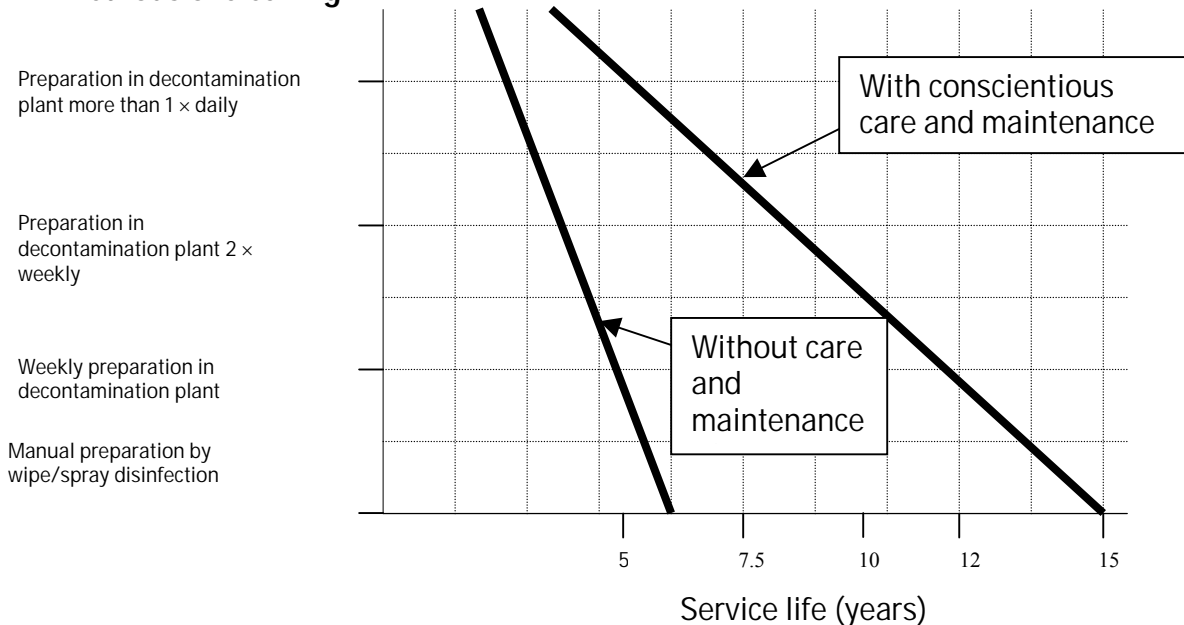

3. Explanatory notes for carers

This documentation contains all information necessary for the normal operation of Völker hospital beds.

Völker accepts no guarantee claims whatsoever for damage, injury or accidents caused by carelessness, inattentiveness or the incorrect use of the Völker hospital bed. In this connection, the question of culpability is irrelevant.

If required by the customer, Völker or its representative is willing to give carers basic training in the operation of the bed.

The participation in such training sessions for carers must be confirmed with name, date and signature on a form specifically intended for this purpose, which must be counter-signed by Völker or its representative.

The safety regulations contained in this documentation – more especially those in Chapter 2 – must be strictly obeyed and adhered to at all times.

The conscientious observance of the safety regulations, modes of behaviour and instructions described in this manual guarantees the safety of carers, patients and others.

Please note that functional features marked as special equipment are only available in beds so equipped.

4. Review: Types of patient positioning

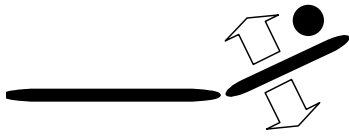

RAISED BACK SECTION

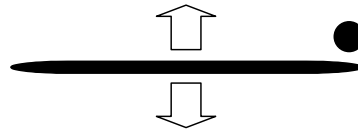

FLAT POSITION, height adjustment



RAISED LOWER LEG SECTION

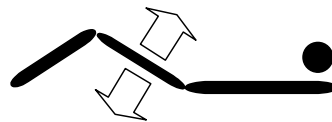

RAISED UPPER LEG SECTION

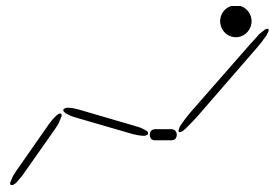

SITTING POSITION



FULLY HORIZONTAL LOWER LEG POSITION



REVERSE TRENDELENBURG POSITIONING
(FOOT RIGHT DOWN)



TRENDELENBURG POSITIONING
(HEAD RIGHT DOWN)

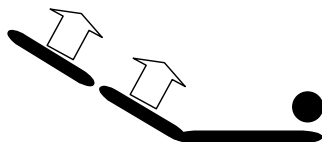

SHOCK POSITIONING

5. Operational units

General operating instructions

5.1.1. Safety class

The bed conforms to Safety Class II and Type B according to DIN EN 60601-1 and VDE 0750, Part 1.

The bed is fitted with a connection for a voltage compensator.

The electricity supply via the charger is safety insulated and is equipped with a fail-safe transformer that charges the battery with electrical energy.

5.1.2. Operating interval

The maximum operating interval of the electrically-powered bed functions is given on the bed (name plate) and/or in the technical data sheet as "Int 2 min / 10 min", ie each bed function may only be continuously operated for a maximum of 2 minutes in any period of 10 minutes.



Automatic safety devices kick in if the maximum operating interval of 2 minutes is repeatedly or markedly exceeded, leading to the power drives cutting out. The bed must then be inspected and tested!

An integrated time-lag device hinders the accidental or brief operation of the keyboard and consequent movement of the mattress-frame. This device requires that users consciously press and hold down the relevant key. Functions then kick in after a time-lag of ca. 0.5 seconds.

5.1.3. Batteries

When fully charged, the bed batteries have a theoretical capacity sufficient to power all bed functions with a working load of 170 kg continuously for ca. 15 minutes. After that, only the emergency functions (trendelenburg/reverse trendelenburg) and booting can be carried out.



**If the bed is put into storage with disconnected charger, then self-discharge through leakage leads to the exhaustion of the battery!
Totally discharged batteries can be so badly damaged as to necessitate their premature replacement!
In order to achieve a long service life, the correct treatment of both the battery and the charger is absolutely essential!**

5.1.4. Built-in safety cut-out

The bed is fitted with a built-in electronic safety cut-out that hinders the overloading of the drives. In the event of overloading, the drives are automatically switched off. For safety reasons, thereafter electrical adjustment is only possible in the opposite direction.



This adjustment in the opposite direction is also required if the drive is already in end-position!

After having been moved in the opposite direction, normal adjustment of the mattress-frame is automatically reinstated.

5.2. Review: Bed functions



Height adjustment



Back section adjustment



Upper leg section adjustment



Lower leg section adjustment

Putting bed into service for the first time (initiation)

Location

The bed is authorised for use solely in dry rooms (Technical data sheet). A mains power supply socket and, if required, a voltage compensator connection must be available in the room in which the bed is to be used.

The bed is mobile without the need for auxiliary transport equipment.

The bed may only be moved on firm surfaces. Moving the bed over obstacles greater than 2 cm in height is prohibited. Gradients may not exceed an angle of 10°.

The bed is supplied complete and can be set up without first having to remove transport equipment.

5.2.1. Mechanical initiation

- Push the head- and footboards supplied into the corner connectors of the bed-frame.
(see 5.3.10)
- Handset connection

There is a socket for the handset on the LH and RH face of the central bearer below the seat section. Pull off the protective cap and insert the handset plug. Make sure that the socket that is not in use always remains sealed with the protective cap!



If the handset is removed from the bed, then the socket must immediately be resealed with the protective cap (maintenance of safety standards IP-X5 or IP X6).

- Apply brakes



It can happen that the brakes are not applied when the bed is put into service for the first time or brought back into service after a period out of use. Press down the foot-operated brake bar to apply the brakes. When brake bar is at an angle of 45° to floor, brakes are fully applied.

- Fit accessories

5.2.2. Electrical initiation



- Connect battery charger to mains power supply (230V ~ / 50 Hz socket).



Risk of injury! Do not place charger above patient's head as plug can be pulled out of socket by exerting tension on spiral cable!

Wall-mounted chargers are to be fixed on to the wall and the cable connected to the mains power supply socket **before** the bed is put into service for the first time.



It is **absolutely essential** to protect the charger against moisture-penetration. This can endanger patients, carers and others.

- Connect charger to bed

Insert the charger plug (spiral cable) into the connecting cable socket on the central bearer of the bed (below seat section).



Make sure the plug is fully inserted by checking that there is no free space between the coupler and the plug. If the connection is faulty, the battery will not charge.

A secure connection and the battery charging process is indicated by the green diode on the charger. The diode must glow as soon as the charger is connected to the bed. The diode goes out when the battery is **fully charged** and no charging is in progress.

- Checking condition of battery

see 6.7.7.

- Activating bed

It is necessary to cancel the deactivation of the functional keys to use the handset and the carers' keyboard after the bed has been switched on.

see 6.7.12.

- Functional test

see 7.

The bed is now ready for use.

5.3. Operation with handset

- If necessary, first cancel deactivation of handset on carers' keyboard (see 6.7.12.).

The following nine functional modes can be selected with the handset:

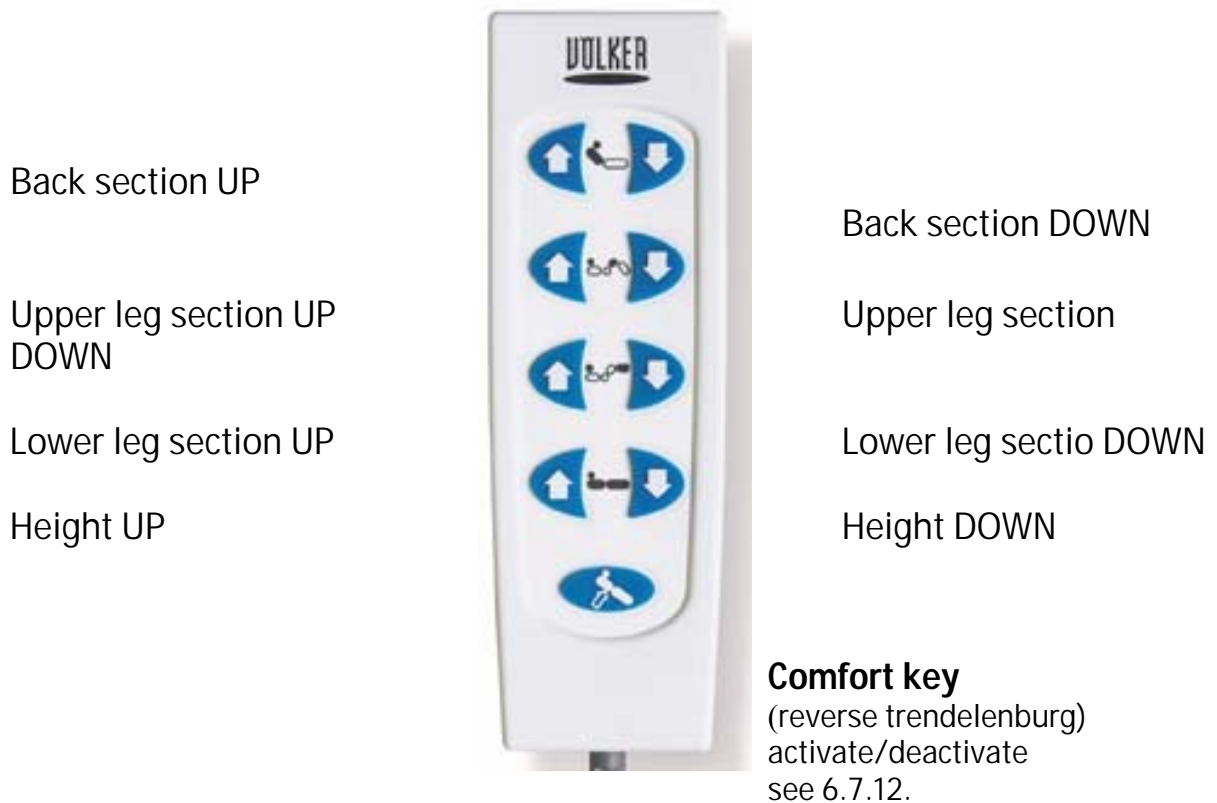

All UP/DOWN modes are selected simply by pressing the appropriate key.

Summary of functional modes:

Back section UP - continuous raising of back section to enable the patient to sit up.

Back section DOWN - continuous lowering of back section to enable patient to lie down.

Upper leg section UP - continuous raising of upper leg section so that knee is bent.

Upper leg section DOWN - continuous lowering of upper leg section so that the mattress-frame is flat again.

Lower leg section UP - continuous raising of lower leg section when the upper leg section is raised so that knee can be stretched out.

Lower leg section DOWN - continuous lowering of lower leg section so that knee can be bent at a more acute angle.

Height UP - raises the whole mattress-frame to the required height.

Height DOWN - lowers the whole mattress-frame to the required level.

Comfort key - tilts the whole mattress-frame by lowering the foot of the bed.

Note: All handset functional modes are clearly marked by pictographs and directional arrows.



A socket for the handset is provided on the LH and RH side of the bed beneath the seat section. It is essential that the socket that is not in use is sealed with the cap. When the handset is disconnected, then both sockets must be sealed. Failure to do this can result in malfunctioning or breakdown.







Important: Certain handset modes can be blocked at the carers' keyboard to prevent their unauthorised use. The deactivation of the handset may only take place after a careful assessment of the patient has shown such a step to be appropriate. If the handset has been installed within the patient's reach, detailed care records must be correctly kept (it is in any case essential to make sure that no dangers can arise).

Operation of electrical functional modes

5.3.1. Adjustment of back section



- If necessary, first cancel deactivation of handset on carers' keyboard.
- **Raise back section** by pressing  - key on handset or key 5  on carers' keyboard until back section is in required position.
- **Lower back section** by pressing  - key on handset or key 6  on carers' keyboard until back section is in required position.

The angle of elevation of the backrest is shown in the display in °:



If the mode is deactivated, a padlock symbol is shown instead of the angle of elevation:



The back section can be raised to a maximum angle of elevation of 75°.

For safety reasons, the movement of the back section is coupled with that of the upper leg section (minimum aperture angle 90°) to prevent the entrapment of patients. In the case of raised or deactivated upper leg sections, the maximum angle of elevation of the back section can be limited.

During raising, the back section shifts towards the headboard by a maximum of 150 mm. This increases patients' comfort by stopping them from sliding down the bed.



When overloaded (≥ 90 kg), the back section is automatically deactivated.

 **Warning:** When lifting the back section with raised safety frames, it is **absolutely essential** to make sure that the limbs of patients or others are not poking through or resting on the safety frames (see also Chapter 1.10 and 0)!

5.3.2. Adjustment of upper leg section



- If necessary, first cancel deactivation of upper leg section on carers' keyboard.

- **Raise upper leg section** by pressing  - key on handset or key 7  on carers' keyboard until upper leg section is in required position.

- **Lower upper leg section** by pressing  - key on handset or key 8  on carers' keyboard until upper leg section is in required position.

The angle of elevation of the upper leg section is shown in the display in °:

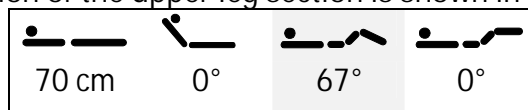

If the mode is deactivated, a padlock symbol is shown instead of the angle of elevation:

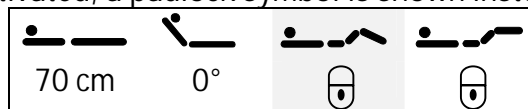





When overloaded (≥ 90 kg), the upper leg section is automatically deactivated.

 **Warning:** When lifting the leg sections with raised safety frames, it is **absolutely essential** to make sure that the limbs of patients or others are not poking through or resting on the safety frames (see also Chapter 1.10 und 0)!

5.3.3. Adjustment of lower leg section (horizontal lower leg)



- If necessary, first cancel deactivation of leg sections on carers' keyboard.
- **Raise lower leg section** by pressing  - key on handset or key 9  on carers' keyboard until lower leg section is in the required position.
- **Lower the lower leg section** by pressing  - key on handset or key 10  on carers' keyboard until lower leg section is in required position.

The angle of elevation of the lower leg section is shown in the display in °:

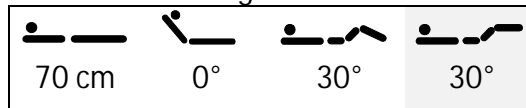

If the mode is deactivated, a padlock symbol is shown instead of the angle of elevation:

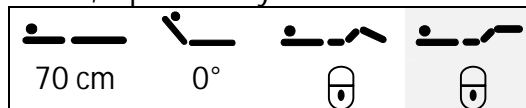

When overloaded (≥ 90 kg), the lower leg section is automatically deactivated.





Maximum position:

upper leg section 66° - lower leg section horizontal = horizontal lower leg position.

 **Warning:** When lifting the leg sections with raised safety frames, it is **absolutely essential** to make sure that the limbs of patients or others are not poking through or resting on the safety frames (see also Chapter 1.10 und 0)!

Height adjustment of bed



- If necessary, first cancel deactivation of height adjustment on carers' keyboard.
- **Lift whole mattress-frame** by pressing  - key on handset or key 3  on carers' keyboard until mattress-frame is at required height.
- **Lower whole mattress-frame** by pressing  - key on handset or key 4  on carers' keyboard until mattress-frame is at required level.

The height of the mattress-frame above the floor is shown in the display in cm:

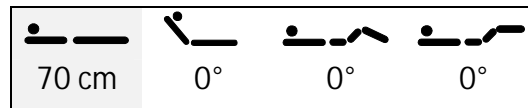

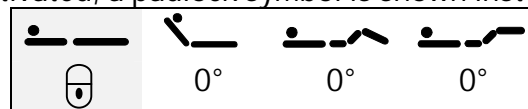

If the mode is deactivated, a padlock symbol is shown instead of the height:



Note: Völker hospital beds are equipped with whispering telescopic jacks that increase the convenience of carers and patients by enabling them to adjust the height of the mattress-frame continuously von ca. 40 cm to ca. 80 cm. In highest position, back problems among carers are avoided and communication with patients improved. The lowest position makes it easier to get out of and into bed. Similarly, the height adjustment mode can be used as an elevator in that patients sit on the edge of the bed and then raise it so that they can easily stand up without having to lift their own weight. The safety frames can be used as further support.

 **Warning:** To avoid the risk of injury to patients by falling, we recommend that the bed is fully lowered when in routine use!

-
-  Warning: Before lowering bed, make sure that the space between mattress-frame and chassis is free of persons, limbs, bedding or other objects. Ensure that brakes are fully applied before patients access or exit bed!
-  Warning: When lifting or lowering the mattress-frame with raised safety frames, it is **absolutely essential** to make sure that the limbs of patients or others are not poking through or resting on the safety frames (see also Chapter 1.10 und 0)!





5.3.4. Trendelenburg and reverse trendelenburg positioning



- If necessary, cancel deactivation of this mode on the carers' keyboard.
- The S 960-1 mattress-frame can be put into the trendelenburg or reverse trendelenburg position required by carers, irrespective of the height of the bed.
- For the trendelenburg position (head downwards), press key  until the required angle of tilt has been reached. The angle of the trendelenburg position is shown in the display. The pre-set maximum angle of tilt amounts to 14°.



The automatic function trendelenburg position cannot be interrupted via the handset, only by operating the carers' keyboard.

- For the reverse trendelenburg position (feet downwards), press key  until the required angle of tilt has been reached.
- To return to ground position, press key  or  until the required position has been reached. If the height adjustment mode is deactivated, then return to ground position by pressing key  or .



If the lifting gear is faulty or the battery is not charged, the trendelenburg facility no longer functions. In this case, the patient may have to be transferred to another bed.



The trendelenburg and/or reverse trendelenburg functions are still operable when the height adjustment function has been deactivated.

5.3.5. Sitting position (cardiac)

with simultaneous operation of reverse trendelenburg function



Only to be carried out by qualified professionals!

Ground position: the mattress-frame is horizontal and all sections are parallel to it.

a. When automatic mode is **deactivated**:

- The simultaneous pressing of keys 14 and 2 causes the reverse trendelenburg symbol to appear in the display and sets relevant movements in train until the keys are released.



+



b. When automatic mode is **activated** (see 6.7.):

- The simultaneous pressing of keys 14 and 2 causes the reverse trendelenburg symbol to appear in the display and sets relevant movements in train automatically until end-position has been reached.



To reinstate ground position, press key 4 until bed height has returned to ground position.

Then press keys 6 + 8 until all mattress-frame sections are parallel to mattress-frame.

5.3.6. Voltage compensator cable connection

The bed is equipped with a voltage compensator cable connection according to DIN 42801. Only use tested cables that meet the requirements of DIN 42801 (see Accessories).

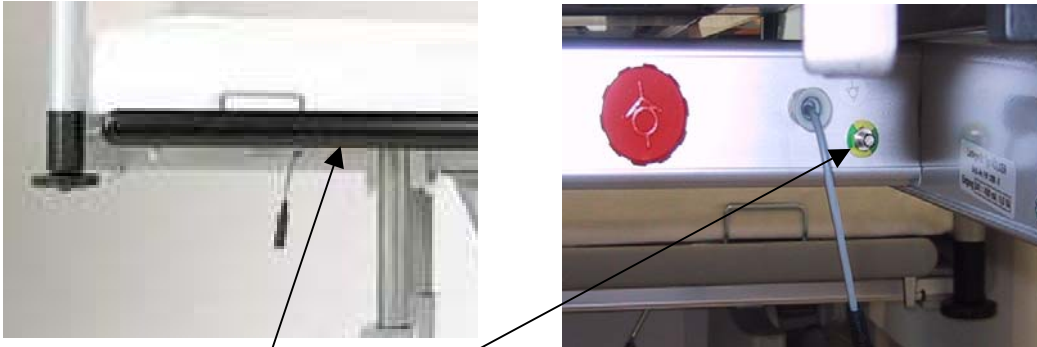

The connecting bolt for the voltage compensator cable is situated on the LH end of the central bearer next to the battery charger socket. It is marked with the voltage compensator symbol.



When using the bed with other electro-medical equipment, the voltage compensator cable **must** be connected to the voltage compensator socket in the hospital.

(See *Regulations for the Use of Electro-Medical Equipment in Intracardiological Operations*, DIN VDE 0753, Part 2 /02.83).

Operation of mechanical functions

5.3.7. Four-caster central braking with total & directional locking facility



**Bed movable only
straight ahead**

**Bed movable in
any direction**

**Bed with
brakes applied**

A brake-bar is fitted to the footend of the chassis for operating the central braking system. The brake-bar has three switch positions:

- horizontal position – bed can be moved in any direction
- pointing downwards towards floor – all brakes fully applied
- pointing upwards towards mattress-frame – bed can be moved only straight ahead. To set straight-ahead tracking, the bed must be moved forwards until the castors are pointing front to back and the locking device audibly engages.



Warning: The brakes must always be applied when patients are accessing or exiting the bed! In point of fact, the brakes must always be applied when the bed is in use, unless it is being moved to another location (see also Chapter 1.9.).

5.3.8. Mechanical fast release of back section, CPR function



Only to be carried out by qualified professionals!



To let down the back section quickly, take hold of it and pull up the red lever on the right or left side of the mattress-frame beneath the seat section. The back section can then be pushed down quickly by applying pressure.

Lowering can be interrupted at any point by releasing the red lever.



Warning: It is essential to hold the back section firmly so that it does not pose a threat to patients by suddenly falling!



Caution: After having operated the CPR function, the back section must always be put into lowest position. Do this either by pressing the  key on the handset or key 5  on the carers' keyboard. Alternatively, the back section can be put into lowest position by operating the red lever beneath the seat section as described above (CPR function).

The full range of back section adjustment of 75° can no longer be used if this instruction is ignored.

5.3.9. Use of safety frames

5.3.9.1 Operation of safety frames

The S 960-1 has split safety frames on both sides. They are fully integrated into the mattress-frame and reposition automatically during mattress-frame adjustment. When not in use, the frames are pushed out of sight beneath the mattress-frame. This gives unobstructed access to the accessories bar and facilitates the use of bed jacks, even when the bed is in lowest position.

When raised, the safety frames:

- protect patients against falling out of bed
- support patients when accessing or exiting the bed



How to raise a safety frame:

- Pull safety frame horizontally out of its location as far as the end-stop. Then fold it upwards until vertical and press it down about 1 cm. Once vertical, the frame locks into position automatically.

**Raising to and lowering from mattress-height to 34 cm.**

Release locking mechanism by pressing release button (according to version) and pull frame up to a height of 34 cm until both ends lock into position. To lower frame, press release button again and push the frame downwards.

**Danger of entrapment**

How to lower a safety frame:

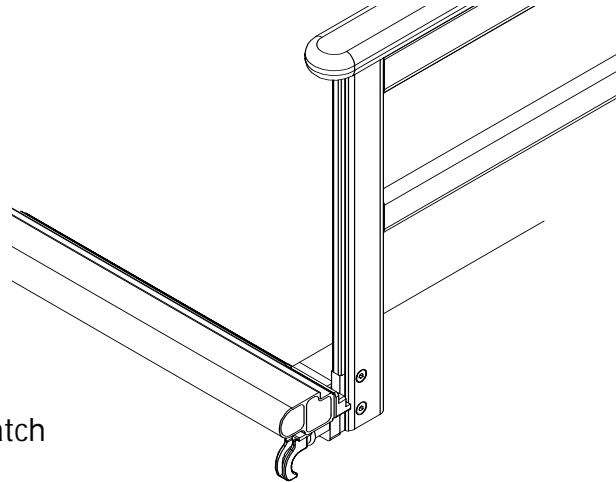

Retaining catch

Pull out retaining catch at end of mattress-frame.

- Lift safety frame as far as end-stop and then fold down sideways until horizontal.
- Push safety frame fully into its location beneath the mattress-frame.

To protect patients, the safety frames can be raised individually or together, as appropriate.

Raising all four frames provides patients with complete protection.

Due to their exceptional stability, the frames can be used as a depository for bedding or to provide additional support during medical procedures, eg physiotherapy.

The stability of the frames also stimulates the patient mobility by providing safe support when sitting up or getting out of bed.

The frames can be used in four possible configurations on each side:

1. Both frames fully lowered.
2. Headend frame raised to top edge of mattress and footend frame lowered allows carers to carry out procedures with raised safety frame.
3. Headend frame fully raised and footend frame fully lowered.
4. Both safety frames fully raised.

These four configurations makes the Völker S 960-1 highly flexible in use:

1. With all frames down, carers have unhindered access to the mattress-frame. The bed looks like a normal bed, hence contributing to a pleasant and unthreatening atmosphere.
2. With headend frames raised to top edge of mattress and footend frames lowered, patients can use the safety frame as an aid to getting into and out of bed. In this position, the frames clearly mark the limits of the mattress-frame, while at the same

time allowing patients to come and go at will. Furthermore, care procedures can be carried out without first having to lower the safety frames.

3. With headend frames raised and footend frames lowered, patients can use the frames as an aid to getting into and out of bed. In this position, the frames clearly mark the limits of the mattress-frame, while at the same time allowing patients to come and go at will.



Caution: Danger of entrapment when footend frames are later raised!

4. When all four safety frames are fully raised, patients enjoy the greatest possible protection against falling or rolling out of bed.

Appropriate use of safety frames as an aid to getting out of bed.



General warning on the use of safety frames



Warning: Anybody whose duties include handling safety frames **must read and obey** the following instructions:



1. When operating the back section, upper leg section, lower leg section, telescopic jack or safety frames, it is essential to make sure that the patient does not come into contact with the frames, and that no part of the body is poking through them.

2. If the safety frames are used with a child or with a patient whose mental state appears to make their use appropriate, ensure the handset is kept out of reach. Should, however, the handset be within reach of such a patient, then detailed care records must be correctly kept (in all cases, it is vital to ensure that no dangers can arise through the use of safety frames).
3. Protective covers are available for the safety frames that offer additional protection against injury caused by contact with the frames. The use of covers is recommended in the case of patients whose physical or mental state makes them particularly susceptible to injury through unavoidable contact with the frames. The use of protective covers does not, however, free carers or patients from exercising due care when operating the bed.
4. When the safety frames are in use, they must **always** be either raised until they lock into position, or lowered to their end-stops.
5. The safety frames should **always** be grasped at the ends with **both** hands and gently guided upwards or downward.

5.3.10. Removal of headboard and footboard

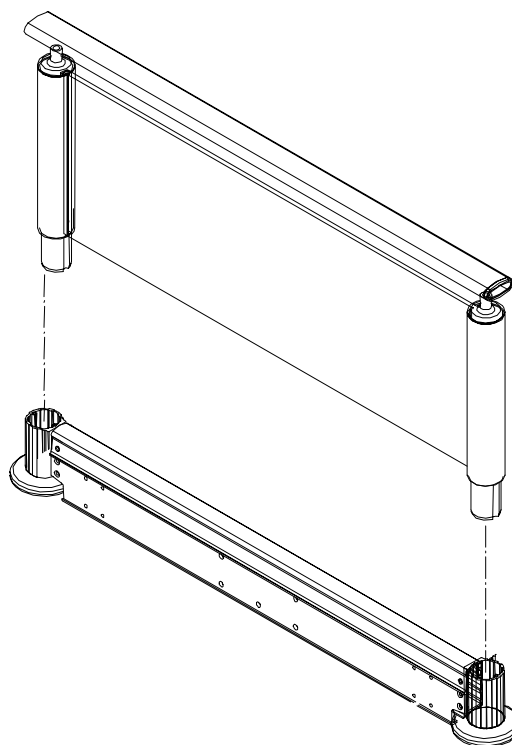

The headboard and footboard can be pulled off or pushed onto their fixing on the headend or footend cross-members without the help of tools.

Wall buffers

The horizontal and vertical wall buffers protect both the bed and walls during transport.

Operation with carers' keyboard

Description of keys

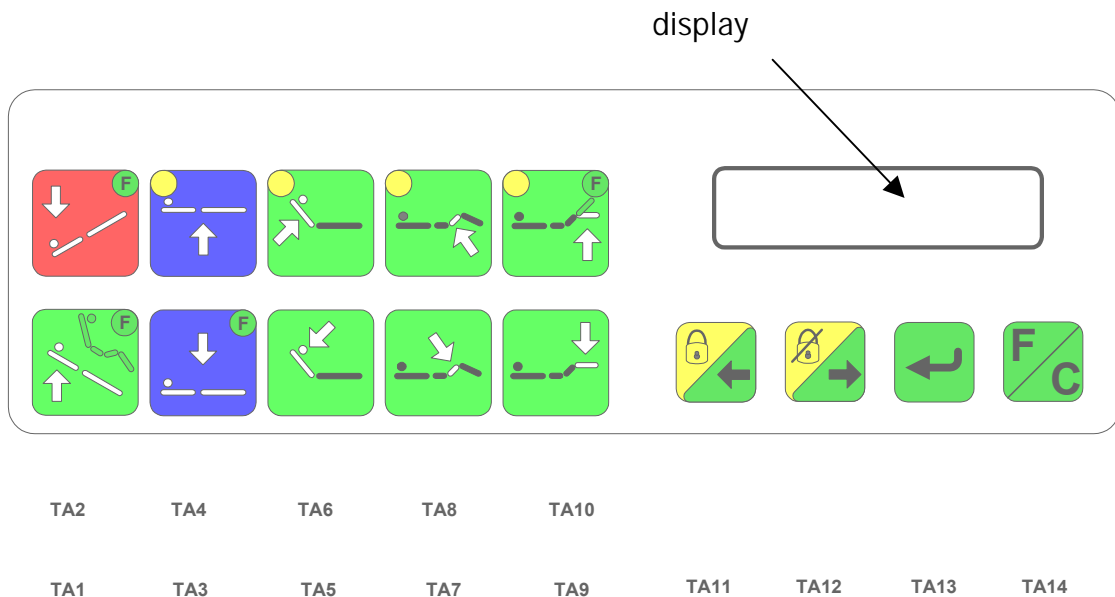

The carers' keyboard is situated at the foot of the bed. It must be pulled out of its location before use.

Motional key 1:	trendelenburg (headend of mattress-frame downwards)
Motional key 2:	reverse trendelenburg (footend of mattress-frame downwards)
Motional keys 3 + 4:	height adjustment UP/DOWN
Motional keys 5 + 6:	back section UP/DOWN
Motional keys 7 + 8:	upper leg section UP/DOWN
Motional keys 9 + 10:	lower leg section UP/DOWN
Menu key 11:	deactivation (padlock); motional keys with yellow dot/back key/cursor to left
Menu key 12:	reactivation (padlock crossed out); motional keys with yellow dot/forward key/cursor to right
Menu key 13:	enter
Menu key 14:	functional key/erase key

General safety information:

After operating the carers' keyboard, carers must remain present until activity "peters out" after about 10 seconds.

Menu

- Call up menu by pressing key 12 (cursor right) and functional key 14 simultaneously until Menu appears in display.

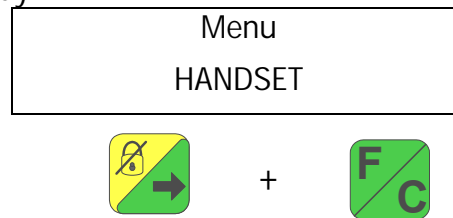

- Menu functions:
Handset ⇒ Bed data ⇒ Limitation of travel ⇒ Limitation of current ⇒ Date ⇒ Time
⇒ Language ⇒ Service functions ⇒ Last technical check ⇒ Last cleaning ⇒
Automatic mode ⇒ Handset (comfort key) ⇒ Back ⇒

- Move around the menu by pressing cursor keys 12 or 11:



forwards



backwards

- Press enter key 13 to select or confirm menu function:



- Press cursor keys as follows to alter values:

right (12)



= increase value

left (11)



= decrease value

This is only possible, however, if the value has been previously selected by pressing enter key (13) and the cursor is positioned beneath the value.

- Press enter key 13 to complete an alteration in value:



- Leaving the menu:

Menu Back

+



or



Information about PIN codes:

Carers' PIN code:

Menu function **Limitation of travel**

Key 1, Key 3, Key 7, Key 9

Technicians' PIN code:

Menu entries **Limitation of current, Automatic mode, Last technical check, Handset comfort key**

Key 8, Key 9, Key 7, Key 10

Limitation of travel



Limitation of travel is only possible in manual mode, not in automatic.

1. Call up menu (see 6.7.2).



2. Select and confirm menu function **Limitation of travel**.



3. Key in carers' PIN code (see 6.7.2):

PIN:****
Limitation of travel

4. Confirm PIN code:



5. Possible selection:



Telescopic jack

	80cm
	40cm

Back section

	70°
	0°

Leg sections

	67°
	0°

Trendelenburg/reverse trendelenburg

	14°
	14°

Back without change

Menu

Back



6. Confirmation of selection:



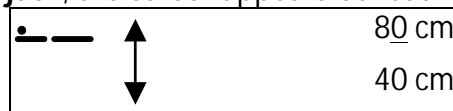

Example: Changing travel of telescopic jack:

- On selecting **Telescopic jack**, the cursor appears beneath the upper value:



- Decrease value with key: 
- Increase value with key: 
- Confirm with enter key: 
- The cursor then appears beneath the lower value:



- Decrease value with key: 
- Increase value with key: 
- Confirm with enter key: 

(Should value remain unchanged, then confirm present value by pressing enter key)

7. Select next function **Limitation of travel** or **Back**.

8. Leave menu (see 6.7.2)
Select and confirm menu function **Back**.

Date

1. Call up menu (see 6.7.2).



2. Select and confirm menu function **Date:**



3. On selection, the cursor appears beneath day of week.
Change day of week with cursor key.

	Menu
Datum	<u>M</u> o16.10.00

4. Confirm by pressing enter key. Cursor appears beneath day of month.
Change number with cursor key.

5. Confirm by pressing enter key. Cursor appears beneath month.
Change number with cursor key.

6. Confirm by pressing enter key. Cursor appears beneath year.
Change number with cursor key.

7. Confirm by pressing enter key.

8. Leave menu (see 6.7.2)
Select and confirm menu function **Back.**

Time

Call up menu (see 6.7.2).



Select and confirm menu function **Time:**



On selection, the cursor appears beneath hour.
Change number with cursor key.

	Menu
	12:3 <u>2</u>

Confirm by pressing enter key. Cursor appears beneath minute.
Change number with cursor key.

Confirm by pressing enter key.

Leave menu (see 6.7.2)
Select and confirm menu function **Back.**

Language

1. Call up menu (see 6.7.2).



2. Select and confirm menu function **Language:**



3. On selection, the active language appears in display:
Change language with cursor key.

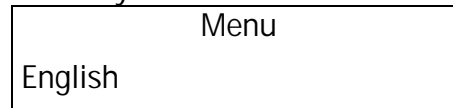

4. Confirm new active language:



5. Leave menu (see 6.7.2)
Select and confirm menu function **Back..**

RESET

If it not be possible to return the bed to ground state after an error message by normal means (see 6.7.5) – because, for example, the patient may not be moved – then a **manual reset** should be carried out as follows:



DO NOT move the bed during RESET procedure!

- Procedure:
Press keys 11, 12, 13 and 14 (keys beneath the display) simultaneously.



A hardware reset is carried out.

The bed is switched off.

Restart the bed by pressing any key.

Error messages are cancelled and the bed is ready for use again.

Active settings at the time of reset are not lost.

Eco-mode

If the battery charger is not connected, the bed goes into eco-mode 15 seconds after the last activation of a key. The control module is switched off and no current flows.

The display is blank and the POWER diode is out.

When the charger is plugged in, the POWER diode glows green and the display remains blank.

The display switches on after the first activation of a key and then remains turned on.

If no key is activated for 15 seconds, only the background illumination of the display switches off to save energy. The illumination switches on again as soon as a key is activated.

5.3.11. Reinstating ground level state (booting)



Caution:

- Depending on their initial position, all mattress-frame sections move simultaneously into lowest position! Make sure the bed has sufficient room for manœuvre during this autonomous process!
- The bed must be unoccupied during booting!
- People around the bed must keep a safe distance!
- Booting can be interrupted by pressing any key on handset or carers' keyboard!

Returning to the ground level state can be initiated when the bed is switched off but only after a reset has been done. (see 6.7.3 Reset or 6.7.4 Eco-mode).

- Press keys 14 (F/C) and 11 simultaneously for about 5 seconds.

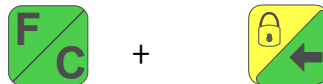

Release keys when message **Booting active** appears in display. All functional sections now return to their ground level state simultaneously.

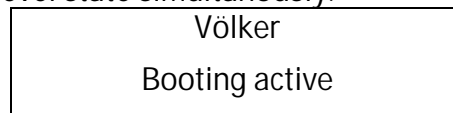

After booting has been interrupted, briefly press key 14 to continue booting until it has been completed.



Caution:

During booting, all program parameters return to their ground level state!
Ex-works settings (**not** automatic mode and handset comfort key) are reinstated!

5.3.12. Error messages from control

Control errors appear in the display.

Examples:

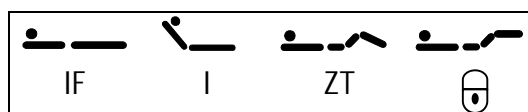

Message	Cause and effect	Corrective measure
<ul style="list-style-type: none"> IF (impulse error) 	<ul style="list-style-type: none"> ◆ As no impulse has been received from the sensor, the relevant motor does not work. 	<ul style="list-style-type: none"> ⇒ Cancel deactivation by carrying out reset (see 6.7.4) ⇒ If the cause of the missing impulse has not been found, the function will automatically deactivate and the display is as described above.
<ul style="list-style-type: none"> I / IF (current limit) 	<ul style="list-style-type: none"> ◆ Cut-out because of overload 	<ul style="list-style-type: none"> ⇒ In case of message I, solve overloading by travelling in opposite direction. In case of IF, call Völker Service
<ul style="list-style-type: none"> ZT (time limit overrun) 	<ul style="list-style-type: none"> ◆ End-stop cut-out not reached when returning to ground level state (booting) 	<ul style="list-style-type: none"> ⇒ Break off booting process and start again (see 6.7.5)
<ul style="list-style-type: none"> Battery saver – charge battery or Battery saver – waiting time < value > min <p>and all functional modes inhibited (display when a key is activated:  links green, POWER diode glows green)</p>	<ul style="list-style-type: none"> ◆ Emergency battery saver has kicked in because battery voltage has sunk to 19.5 V. 	<ul style="list-style-type: none"> ⇒ It is absolutely necessary to recharge battery (see 6.7.8)
<ul style="list-style-type: none"> DZSE < value > < val.> < val.> < val.> < val.> < val.> (HK) (HF) (RT) (OS) (US) 03 04 05 06 07 	<ul style="list-style-type: none"> ◆ Decentral unit inactive 	<ul style="list-style-type: none"> ⇒ Reset
POWER ERROR 1	<ul style="list-style-type: none"> ◆ Monitoring of motor balance 	<ul style="list-style-type: none"> ⇒ Reset (see 6.7.4) and inform after-sales service
POWER ERROR 2	<ul style="list-style-type: none"> ◆ Monitoring of control ◆ Safety cut-out 	<ul style="list-style-type: none"> ⇒ Inform after-sales service

5.3.13. Battery level indicator

The S 960-1 is equipped with a rechargeable battery. In normal use, the battery ensures the operational capability of the bed for about 2 days, even if it is not connected to the charger.

Nonetheless, it is recommended that when the bed is in its usual location it is permanently connected to the charger.

To this end, the charger must be connected to the socket on the central bearer and a mains socket. The jack plug must go fully home, ie there may be no space between the coupler and the plug. If the connection is faulty, the battery cannot charge.

A secure connection and/or the charging process is shown by a green diode on the charger. The green diode must glow as soon as the charger is plugged in.

The green diode on the charger goes out when the battery is full because then no charging can take place.



It is absolutely essential to pay careful attention to the status of the POWER diode on the front face of the carers' keyboard.

This indicates the operational status of the bed, as follows:

- a – POWER diode is **off** = charger not plugged in
- b – POWER diode glows **green** = charger plugged in
- c – POWER diode blinks **green** = charger plugged in + battery saver (see 6.7.8)
- d – POWER diode does **not** glow = charger not plugged in + battery saver (see 6.7.8)

If no key is pressed, the battery level is automatically shown in the display as a bar in % alternating with the date and time.



The operational state of the battery and/or bed must be checked as a matter of course before it is occupied or operated by a patient!



It is essential to pull out the plug-in connection before transporting the bed!



**If the bed is put into storage with disconnected charger, then self-discharge through leakage leads to the exhaustion of the battery!
Totally discharged batteries can be so badly damaged as to necessitate their premature replacement!
In order to achieve a long service life, the correct treatment of both the battery and the charger is absolutely essential!**

When fully charged, the batteries have a capacity sufficient to power all bed functions with a working load of 170 kg continuously for ca. 15 minutes. After that, only the emergency functions and booting can be carried out.

Battery saver

- The battery saver is an emergency cut-out to protect the batteries from damage and to maintain sufficient power reserves for emergency functions.
- The battery saver kicks in when battery voltage falls below 19 V under load



The battery must be charged!

- All functional modes are deactivated.



Exception:
Trendelenburg and reverse trendelenburg safety functions

The following message appears in the display:

Battery saver Charge battery

- When the charger is plugged in or if it is already plugged in, then the POWER diode blinks green and the batteries begin to charge.

The following message appears in the display:

Battery saver Waiting time 150 min

- After an effective charging time (can be interrupted) of 2.5 hours (150 min), the battery saver mode is cancelled. The current waiting time is shown in the display.



Functions that were already deactivated when the battery saver kicked in remain deactivated.

- When replacing the battery, the bed must be rebooted to cancel battery saver mode. At the same time, make sure that all other deactivated modes are also reinstated.

Manual functions

- Motional keys 1 – 10. (see 6.7.1)

Pressing more than one key causes all operations to stop. This makes it impossible to carry out several functions simultaneously.

- An exception is automatic functions (marked F) which can also be carried out manually.
- The current position of the bed is shown in the display during the carrying out of adjustment functions. Limitations of travel can be altered in the menu.
- When a menu key (11 – 14) is operated, the current position of the bed is shown in the display, although no movement is taking place.

Automatic functions

- Automatic functions are marked on the keyboard with an F.
- These keys must be pressed simultaneously with the functional key (F/C) 14 until the symbol of the required function appears in the display:

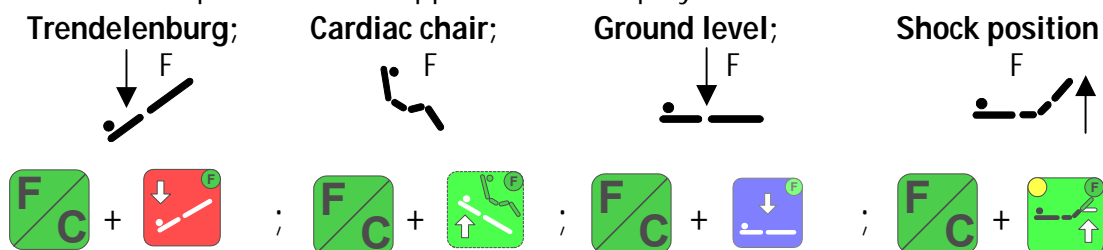

Example:

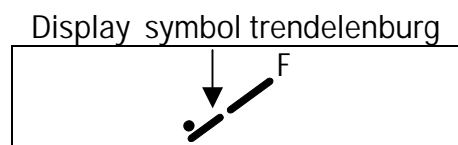

- Release the keys and the bed goes into the required position automatically.
- It is not possible to alter this position.
- If functions are deactivated, then automatic functions are also deactivated.



Exception:

Trendelenburg safety function.



Except for trendelenburg, all functions can be stopped by pressing any key on the carers' keyboard or the (also deactivated) handset. The automatic running of the trendelenburg function cannot be stopped by pressing a handset key.

 When using automatic functions, carers must remain at the bedside to ensure the safety of patients.

Limitation of current

- If limitation of current occurs during movement of the mattress-frame, the process is interrupted and shown in the display.
- The interruption can be automatically cancelled by moving the mattress-frame in the opposite direction.

5.3.14. Deactivating functions

Deactivating motional functions

- The deactivation of functions is achieved via the yellow padlock key 11 and the motional keys marked with a yellow dot. In each case, the whole function is deactivated.

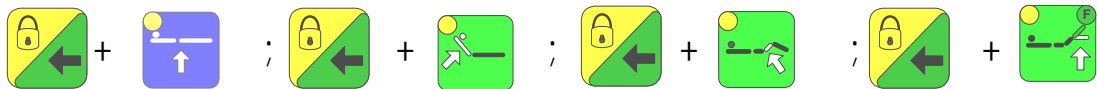

Deactivation of the relevant function is shown in the display by a  :

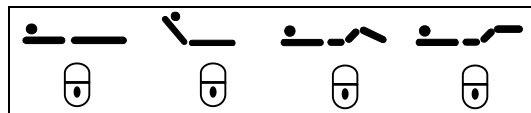

- Reinstatement of deactivated functions is achieved via the crossed-out padlock key 12 and the appropriate motional key. The current position appears in the display.

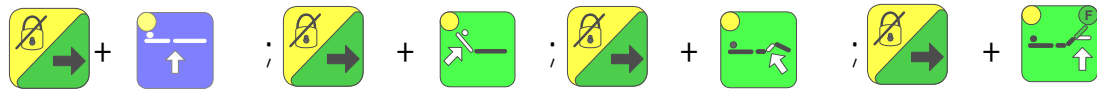

- The simultaneous reinstatement of all deactivated functions is achieved by pressing both padlock keys 11 and 12. This also applies to 6.7.13.2.



- Check if one or more functions has been deactivated by pressing a menu key (11 – 14). The current position or deactivation status of the bed appears in the display without the bed moving.

Deactivating all functions, including emergency functions (since 12/2002)

All functions – including emergency functions such as trendelenburg – must be deactivated if a patient in a critical state is left unsupervised. This is done by simultaneously pressing the padlock key and the functional key:





Danger arising from the unintentional adjustemnt of the bed

Even high quality standards and intensive safety measures cannot completely rule out occasional malfunctioning. The unintentional adjustment of the mattress-frame can also endanger patients. In order to guarantee the greatest possible protection of patients who would be particularly at risk because of the unintentional or faulty adjustment of the mattress-frame, it is **absolutely essential** to deactivate all relevant functions and movements at the carers' keyboard according to IEC safety requirements. The effectiveness of deactivation must then be checked at both the handset and the carers' keyboard.

On change of shift, the new carer responsible for operating the bed must check which bed functions have been deactivated.

Decisions concerning the deactivation of specific electrical functions or of all functions in the interests of maximum patient protection is at the discretion of carers and doctors.



All deactivation orders are cancelled during booting! (see 6.7.5)

Deactivating handset

- Handset deactivation is carried out via the menu (see 6.7.2).

1. Call up menu (see 6.7.2)
2. Select menu function **Handset** (preset)

3. Display shows current status:



Handset ON

4. Change: **OFF** or **ON**



5. Confirm:



6. Select: **OFF** or **ON**:



7. Confirm:



8. Leave menu (see 6.7.2)
Select and confirm menu function **Back**.



All automatic functions can be interrupted by pressing any handset key, also when the handset is deactivated!

Deactivating handset comfort key

a. Deactivation of comfort key via deactivation of height adjustment function

- The comfort key is deactivated when the height adjustment function is deactivated over carers' keyboard:



Deactivation is cancelled after booting!

b. Deactivation of comfort key via menu:

- This procedure to activate or deactivate the comfort key should only be carried out by a technician.

Call up menu (see 6.7.2)

Select **Handset** (2x

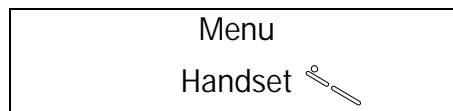

Display shows current status:

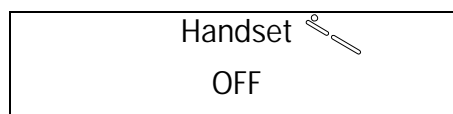

Change:



Confirm:



Key in technician's PIN code (see 6.7.2)

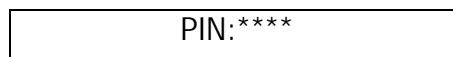

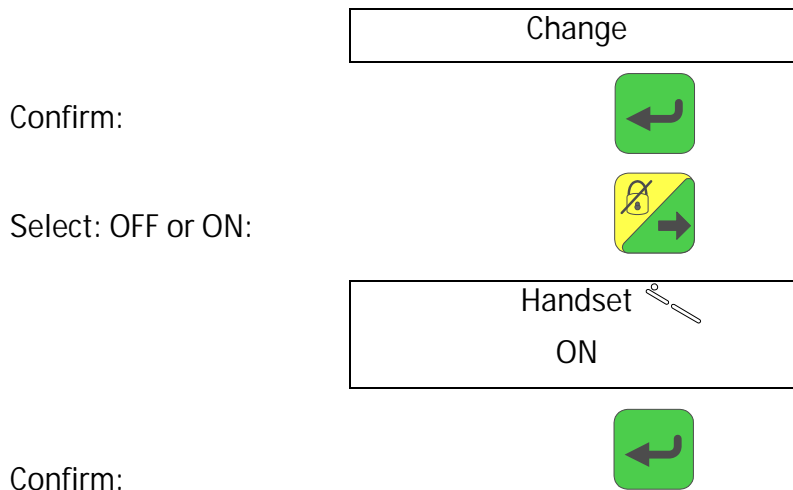

Leave menu (see 6.7.2)

Select and confirm menu function **Back**.



All automatic functions can be interrupted by pressing comfort key, also when it is deactivated!



Deactivation remains active after booting!

Miscellaneous

When the individual mattress-frame sections are returned to ground level state, the relevant impulse counter is set at zero.

All motors have a thermal protection device and a limitation of current facility, which are preset during manufacture.

Although not recommended, preset limitations of current can be altered over a PIN code-protected menu function (see Menu). This setting returns to ground level state during booting.

The limitations of travel of manual functions can be individually set over a PIN code-protected menu function (see Menu). This setting returns to ground level state during booting.

The decentral units (drives) are only live when a motional key (1 – 10) is pressed or when an automatic function is running.

Automatic functions (from 26 June 2002)

From 26 June 2002 onwards, the software offers five automatic functions. On delivery, these functions are deactivated as standard practice. They are activated as follows:

1. Call up menu (see 6.7.2)
2. Select menu function **Automatic med or Automatic Service**

3. Display shows current status:



Automatic med (or service)

ON

4. Change: select OFF or ON



5. Confirm:



6. Select OFF or ON:



7. Confirm:



8. Key in technician's PIN code (see 6.7.2)

PIN:****

Change

9. Confirm:



10. Select OFF or ON:



11. Confirm:



12. Leave menu (see 6.7.2)

Select and confirm menu function **Back**.

Description of automatic functions

Automatic medical functions

1. **Transport position** (jack 70cm, mattress-frame remains unchanged)

Simultaneously press

F key

+

BACK UP key

+

BACK DOWN key



and release F key last.

2. Reanimation position (jack 60cm, mattress-frame flat)

Simultaneously press
F key + JACK UP key



and release F key last.

Automatic service functions:

1. Bed preparation (jack max. height, mattress-frame flat)

Simultaneously press
F key + BACK DOWN key + UPPER LEG DOWN key



and release F key last.

2. MANUAL cleaning (jack max. height, mattress-frame sections max. raised)

Simultaneously press
F-Taste + UPPER LEG UP key + UPPER LEG DOWN key



and release F key last.

3. Cleaning in washing plant (jack min. height, mattress-frame sections max. raised)

Simultaneously press
F key + BACK UP key + UPPER LEG UP key



and release F key last.

Please note that the method of selecting Transport position and MANUAL cleaning may have changed in comparison with previous instructions.

6. Accessories

In order to achieve the greatest possible flexibility in the use of its beds, Völker offers a wide range of easy-to-fit accessories.

Völker S 960-1 hospital beds are equipped with depth-adjustable, end-to-end slide bars for accessories on both sides of the bed.

Please see hospital accessories brochure for details of individual accessories.

 **Warning:** The trapeze is not designed to lift people into or out of bed because of an increased risk of injury through the bed tipping over.

 **Warning:** Do not sit or stand on the bedding depository (optional accessory).

7. Functional test

A functional test **must** be carried out in the following circumstances:

1. When the bed is put into use for the first time.
2. When the bed is to be used by a new patient.
3. When the bed is put back into use after a period in storage.
4. When the bed is put back into use after cleaning and/or disinfection.
5. When it is necessary to identify incidents of malfunctioning or faults.

The test comprises the following testing procedures that **must all** be carried out over the **full range** of adjustment:

1. Back section adjustment
2. Upper leg section adjustment
3. Lower leg section adjustment
4. Height adjustment
5. Trendelenburg/reverse trendelenburg positioning
6. Brakes



Warning: Make sure all functions are working correctly. If a fault is found, the bed must be taken out of use at once and not put back into use until the fault has been corrected!

Functional test

1. Check all visible components for damage, distortion, breakages and broken cables.
2. Check battery level (see % bar on carers' keyboard display) and that the charger is working properly.
3. Check that deactivated functions are correctly displayed (see carers' display). On pressing a menu key, a padlock symbol appears in the display. Check that functions have been correctly deactivated by selecting them on handset. Finally, cancel deactivation and check again for correct display.

4. Raise back section to end-stop with carers' keyboard. Lower it again in short stages.
 The **selected** function must move in the **correct** direction.
5. Check angle limitation by raising back section to end-stop and then raising upper leg section until it switches of automatically. The angle of aperture must exceed 90°.
6. Lower back section to end-stop. Raise upper leg section to end-stop and then lower it to end-stop. Finally, move it briefly in the opposite direction.
 The **selected** function must move in the **correct** direction.
7. Raise lower leg section to end-stop and then lower it to end-stop. Finally, move it briefly in the opposite direction.
 The **selected** function must move in the **correct** direction.
8. Using carers' keyboard, raise and lower jack to upper and lower end-stops. Check for parallel movement of mattress-frame relative to bed frame.
 The **selected** function must move in the **correct** direction.
9. Operate trendelenburg function until it reaches its maximum angle. Return to start position by operating reverse trendelenburg function.
10. Using handset, briefly move back section, upper leg section, jack and lower leg section in both directions.
11. Check brake functions "brakes applied" and "brakes released" by operating brake bar.
12. Check correct functioning of mechanical fast release of back section (CPR).
13. Check correct functioning of safety frame locking mechanism.
14. Reboot bed after longer period out of use or cleaning in a washing plant.
 The bed is always ready for use, ie operational!
In case of malfunctioning or faults, inform the responsible service agency!



Functional test S960

Ident-No.			
Testing procedure		OK	Remarks
Visual checks:			
Functional test:	chassis/telescopic columns		
	mattress-frame		
	emergency lowering		
	trapeze pole fixing		
	mains power cable		
	mains power unit		
	mains power plug		
	internal cabling		
	secure fit of plugged contacts		
	casing of drive assemblies		
	handset cable		
	handset casing		
	safety frames	locking mechanism	
	distortion		
	wear		
head-/footboards	wear		
brakes			
castors	mattress-frame		
drives	chassis		
	synchronisation JACK		
	circuit breakers		
	end cut-out		
Checking accessories (trapeze, safety frame with telescopic slides, ...):			

Functional test result

OK

not OK

Signature:

Date:



Functional test S960 charger and voltage compensator connection

Ident.-No.		
Testing procedure		Measured value
Electrical measurement	device leakage current according to VDE 0751, limit 0.25 mA	
	voltage compensator connection VDE 0751-1, limit 0.20hm	

test result

OK

not OK

Signature:

Date:

8. Cleaning and disinfection

Wipe and spray disinfection

The wipe and spray disinfectant cleaning agents given in the DGHM (Deutsche Gesellschaft für Hygiene und Mikrobiologie = "German Association for Hygiene and Microbiology") list of 1 July 1994 are suitable for cleaning and disinfecting the bed by wiping and spraying. All disinfectants and cleaning agents must be used in the concentrations recommended in the user's manual.

The use of chemical solvents, abrasive cleaning agents of any kind and organic solvents such as halogenated or aromatic hydrocarbons and ketone is **not** permitted.

Follow these instructions when using cleaning agents and/or disinfectants:

- Decontaminants in the prescribed concentrations may not exceed or fall below a pH value of 6-8.
- They may not contain any corrosive or caustic substances.
- They may not contain any substances that alter surface finishes or the adhesive properties of plastics.
- They may not affect the properties of lubricants.
- Water hardness may not exceed 0.9 mmol/l (to 5 degrees d).
Fully desalinated water may not be used.

Chloride	< 100 ppm
Silicate as SiO ₂	< 15 ppm
Iron	< 0,05 ppm
Manganese	< 0.01 ppm
Copper	< 0.05 ppm

This information reflects our current knowledge and experience. It does not exempt users from carrying out their own tests and trials as local conditions, eg water hardness, can vary. A legally binding guarantee of the nature of specific properties cannot be assumed.

The following disinfectant cleaners and rinsing agents have been positively tested by Völker:

Bed frame, Transport trolley, Bedside cabinets Operating theatre shoes Utensils	Products	Function	Active ingredient	Concentrat- ion	Dose
		VDV process			
mattresses	weigosept DF spray	alcoholic spray disinfectant	glyoxal, alcohol	100% 15 min reaction time	dosing plant
beds, bedside cabinets	neoform D plus	disinfection by wiping	QAV, glyoxal	0.5% 4 hours reaction time	dosing aid
	weigosept DF		aldehyde, QAV	0.5% 4 hours reaction time	dosing aid
	neoquat 8		QAV	1% 4 hours reaction time	dosing aid

DR. WEIGERT

Chemische Fabrik Dr. Weigert (GmbH & Co.)

Mühlenhagen 85, D-20539 Hamburg,

phone ++49/(0)40/78960-0 . fax ++49/(0)40/78960-120

We accept no liability for damage caused by the use of unsuitable cleaning agents and/or disinfectants, by the use of incorrect concentrations of such cleaning agents and/or disinfectants or by the incompetent or inappropriate care of beds.

**Danger of electric shock, fire and breakdown**

Always disconnect the bed from the charger before cleaning and disinfecting.

The handset plug and socket are only watertight when connected. As they are not watertight when disconnected, both must be protected from water penetration during cleaning. The plug beneath the seat section must be sealed with the cap. As there is a handset connecting plug on both the left- and right-hand side, it is essential to make sure that the plug that is not in use is always sealed with the cap. Non-observance can lead to malfunctioning and/or breakdown.

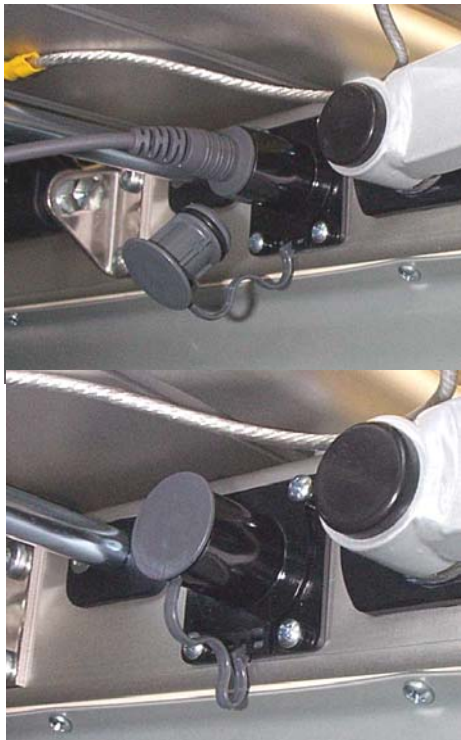
**Charger**

Always disconnect the charger from the mains power supply before cleaning and disinfecting.

The charger may only be used in dry rooms. On no account may moisture penetrate the charger. Should the charger be cleaned or disinfected by (eg) wiping it with a damp cloth, then it must be thoroughly dried before it is reconnected to the power supply.

Spray wands

Cleaning and disinfecting with spray wands attached to high-pressure cleaning appliances is prohibited.

9. Maintenance instructions

In the case of repairs and maintenance work carried out on the bed, Völker only accepts liability for its safety and functional efficiency when

- delivery, maintenance and repair were carried out by a Völker Service technician or by a person authorised to carry out such work by Völker, and
- the bed is used in accordance with the instructions given in the user's manual.

As only maintenance-free motors, electrics and electronics are used in Völker hospital beds, they require very little maintenance. All moving parts of the lifting gear, the compact drives and the safety frames are permanently lubricated during manufacture. As these parts do not need to be relubricated in normal use, the bed has no lubrication points.

Should non-routine maintenance work be necessary, this is to be carried out as laid down in the Völker maintenance manual. Please obtain further information from the S 960-1 hospital bed maintenance manual.

Please refer to the maintenance manual for instructions relating to the technical safety checks laid down by Völker AG in accordance with the regulations governing the operation of medical products.



10. Technical specifications

10.1. Technical data

Length	227 cm
Width	98 cm
Height, top edge head-/footboard	ca. 76,5 cm – ca. 116,5 cm
Castors	4, Ø 150 mm, 120 kg (static) Tente, Intergral single castor
Max. castor load	100 kg (dynamic)
Height adjustment range	ca. 40 cm to 80 cm (dependent on castors)
Lifting range	ca. 40 cm
Mattress displacement	15 cm
Net weight	146 kg
Safe working load	170 kg
Flat fuse 1	Type: C 2A 32V
Flat fuse 2	Type: C 20A 32V
Battery	Type: Cyclon 0809-0012 4x6 V block battery (pure lead) Hawker
Handset	Völker
Linear drive for back + upper leg + lower leg sections	Völker
Lifting gear motor	Bosch
Charger (Schuko-type shaped plug)	Type: FW 1289/15.0888 – Völker
Charger (Euro-plug)	Type: FW 1289/15.0889 – Völker
Charger for wall-mounting (Euro- Stecker)	Type: FW 1289/N/1881781 – Völker Type: FW 1289/N/1819670 – Völker
Manufacturer:	Friemann & Wolf
Mains voltage	AC 230 V~/110 V ~ (US-version)
Nominal current	400 mA
Nominal frequency	50 to 60 Hz
Safety fuse	T 160 mA
Interface	Infrared (only for maintenance carried out by staff authorised by VÖLKER AG)
Temperature range in operation	+ 10°C to + 40°C
Temperature range in storage / transport	- 20°C to + 60°C

Relative humidity	30% to 75%
Atmospheric pressure	700 hPa to 1060 hPa

10.2. Classification

Protection against electric shock	Safety Category II or appliance with internal power source	
Type of protection by encasement according to EN 60259	IP X5 (standard) or IP X6 (optional) suitable for decontamination plants	
Degree of protection of parts handled by users against electric shock according to DIN EN 60 601-1	Type B	
Degree of protection against explosive materials and compounds	The bed is not explosion-protected and may not be used in environments in which there are flammable anaesthetics or cleaning agents (see leaflet ZH 1/200 of professional association)	
MPG category Service cycle	Class I Interval 2 min / 10 min Operational time max. 2 min. Shut-off time 10 min.	
Technical safety check according to regulations on use of medical products	1x per year	

10.3. Meaning of symbols



Degree of protection of parts handled by users according to DIN EN 60 601-1: Type B



Safety Category II (appliance with internal power source)



Caution! – Warning of source of danger, follow user's instructions



Tested for compliance with EMV safety regulations according to DIN EN 60601-1-2



VDE seal of conformity



Symbol for CE seal of conformity



Symbol for UL approval

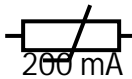

Thermal fuse



Alternating current



Direct current



Only use in dry rooms



Trendelenburg (headend of mattress-frame down)



Reverse trendelenburg (footend of mattress-frame down); automatic mode cardiac chair



Height UP; height adjustment deactivation key



Height DOWN; automatic mode ground level state



Back section UP; back section deactivation key



Back section DOWN



Upper leg section UP; upper leg section deactivation key



Upper leg section DOWN



Lower leg section UP; lower leg section deactivation key; automatic mode shock position



Lower leg section DOWN



Deactivation key in conjunction with respective motional key



Deactivation cancellation key in conjunction with respective motional key



Enter key



Functional key/erase key



- Handset
- Back section UP (left)
- Back section DOWN (right)



- Handset
- Upper leg section UP (left)
- Upper leg section DOWN (right)



- Handset
- Lower leg section UP (left)
- Lower leg section DOWN (right)



- Handset
- Height UP (left);
- Height DOWN (right)



- Handset
- Comfort position

10.4. Dimensions S 960-1 hospital bed

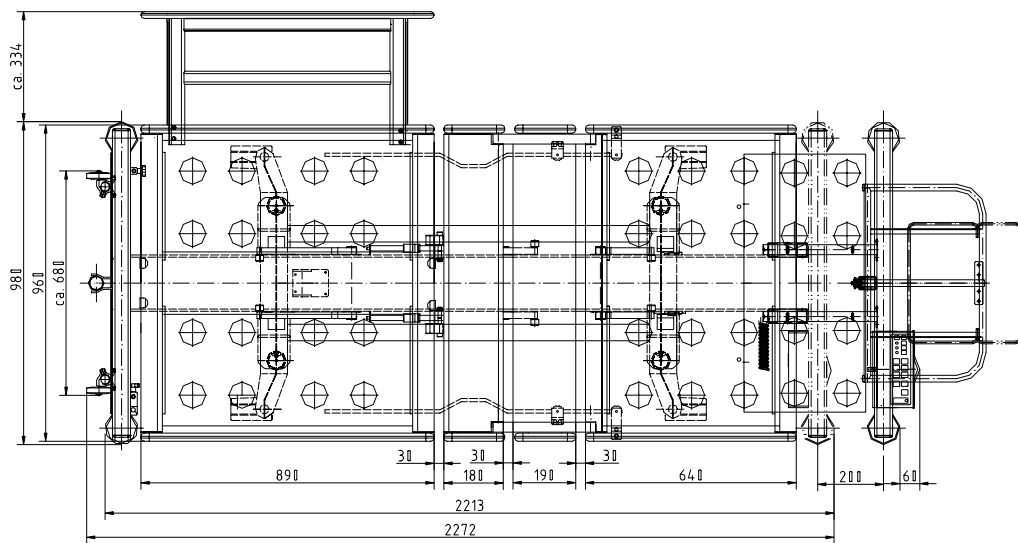
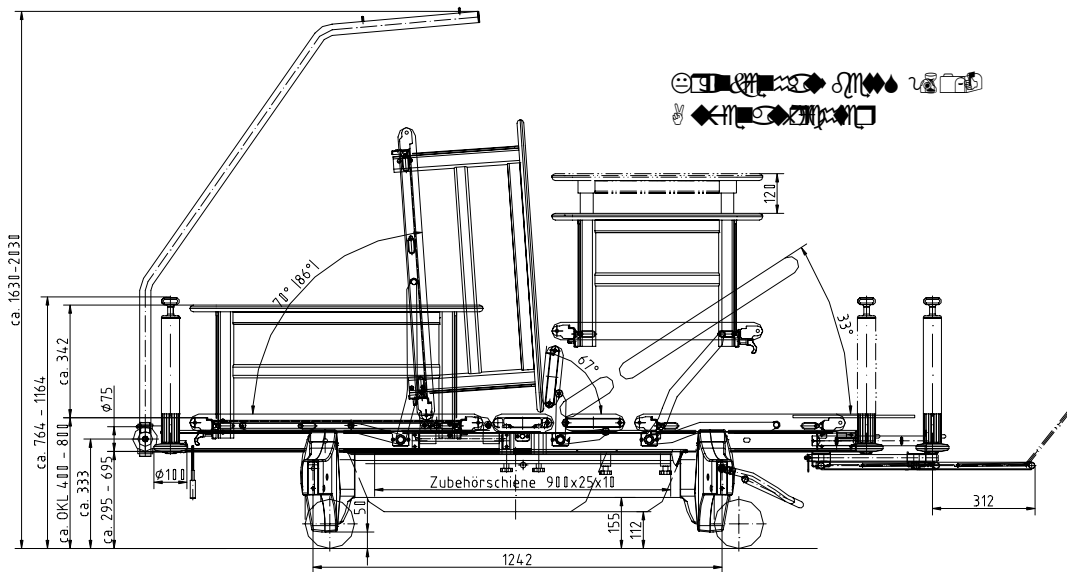

Liegefläche 2100 x 900

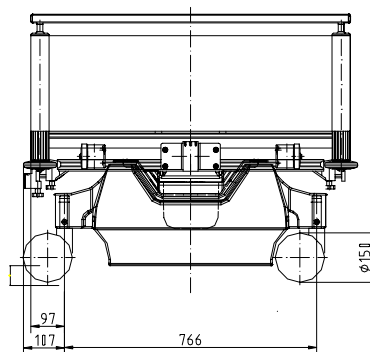
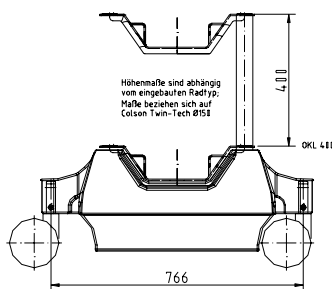



Notes:



Notes:

