

Völker Hospital Bed Instructions for use



Model S 960-2 (B)

© by Völker AG 2002
Völker AG
Wullener Feld 79
58454 Witten
GERMANY

Phone: (02302) 960960
Fax: (02302) 9609616
E-mail: info@voelker.de
Internet: www.voelker.de

All rights reserved. Reprint and duplication – also in parts – is not permitted.
Subject to technical alterations.
The content of this document is subject to changes without notice.
Customers are advised to contact the sales representative in charge before placing an order.

26.07.2005

S 960-2(B)

G26_S960-2B1_Aug2004_E

Introduction

We congratulate you on your decision to buy a Völker hospital bed and we thank you for having confidence in our company and our products.

It is certainly true that you were advised in detail and convinced of the many benefits of our hospital beds before buying. These benefits can actually be found only in this combination of hospital beds.

The fact that a Völker hospital bed, with all the functionality and many benefits, does not look like a hospital bed, has certainly made your purchase much more pleasant.

These instructions for use shall inform you on the technical equipment of the Völker hospital bed and assist you in handling and using all of its functions.



Heinrich Völker

Executive board (chair)

Völker AG

List of Contents

1. General.....	6
1.1 General notes.....	6
1.2 Standard model.....	6
1.3 Copyright protection.....	7
1.4 Warranty and liability	7
2. Safety regulations	8
2.1 Explanation of symbols	8
2.2 Testing the functional safety and condition of the bed	8
2.3 MPG §3, Section 1	8
2.4 Intended use	9
2.5 Misuse	9
2.6 Electromagnetic/electrostatic interferences	9
2.7 Before initial start-up.....	9
2.8 Testing the functional safety and condition of the beds	10
2.9 Position of the hospital bed	10
2.10 Moving the bed	10
2.11 Four castors central braking	10
2.12 Height adjustment.....	10
2.13 Assist rail – “Danger of getting stuck”	11
2.14 Cleaning and disinfection	11
2.15 Mattresses.....	11
2.16 Service/Maintenance	12
3. Technical specifications.....	17
3.1 Technical Data	17
3.2 Classification.....	18
4. Explanations for the nursing service.....	18
5. General operating instructions.....	19
5.1 Power-on time	19
5.2 Batteries	19
5.3 Safety device.....	19
5.4 Putting the bed into operation.....	20
5.5 Mechanical start-up	20
5.6 Connecting the manual control unit	20
5.7 Applying the bed’s brake	20
5.8 Electric start-up.....	21
5.9 Using the battery pack	21
5.10 Operating the assist rails.....	23
5.11 Life expectancy / disposal.....	24
6. Control functions.....	25
6.1 Functional overview of the caregiver’s console.....	25
6.2 Functional overview of the manual control unit	25
6.3 Functional overview of the personel keyboard.....	26

7. Electric functions	27
7.1 Back section adjustment	27
7.2 Leg section adjustment	28
7.3 Bed height adjustment.....	29
7.4 Trendelenburg/Anti-Trendelenburg bearing	30
7.5 Hand control lock.....	31
8. Trouble shooting	32
9. Spare parts	32
10. Cleaning and disinfection	33
10.1 Wipe disinfection	33
10.2 Spray lances	34
11. List of tools	34
12. Service points	34
13. Accessoires	35
14. Forms	35

1. General

1.1 General notes

Thank you for purchasing a Völker hospital bed. This hospital bed was manufactured according to national and international norms and standards and complies with the current state-of-the-art technology.

Völker hospital beds meet the demands on safety and functionality. They were tested against international norms and are designated with the CE seal, confirming that basic requirements for medical products are met.

Please read the basic safety regulations. Please also follow the additional notes given on the following pages (especially with regard to potential warranty claims).

1.2 Standard model

The S960-2 standard model can be delivered in different variants. These variants are as follows:

Variant	Description
Lifting receiver	There are two options available: Single external receiver. The lifting receiver is located in the middle, i.e. outside the lying surface.(standard) Double internal receiver. The lifting receiver is located at the left and right inner side of the head wall.

Description	Variant	
Joint edge	The joint edges come in standard grey.	
Manual control unit	The manual control unit is available with hooks.	
Castors	The castors are in standard design TENTE Integral 150mm, but various customized kinds of castors can be delivered. The designs and the diameters, too, are variable. This might result in a lifting adjustment range varying by 20 mm.	
Head and foot parts	With regard to our different variants of head and foot parts please take note of our brochure.	
Bed extension piece	In order to place a longer mattress, it might become necessary to install a bed extension piece. Using this bed extension piece, you can extend the bed by 200 mm. The bed extension piece comprises a pull-out attachment for moving the foot part and a metal frame for extending the lying surface.	
Lateral grids	The S960-2 bed can be provided in different lateral grid variants:	
	Foot part:	
	Head part:	
	1. Extendible lateral grid 34 cm	Extendible lateral grid, 22 to 34 cm
	2. Extendible lateral grid, 34 to 46 cm	Extendible lateral grid, 34 to 46 cm

* This dimension refers to the top edge of the lateral grid up to the lying surface.
All the possible variants are described in these instructions for use. If you would like to ask for spare parts it is essential that you first determine for which variant you need the spare parts and then determine the corresponding parts list.
In the beds' order specification, you will find an overview of the variants delivered. If it is for a deviation of the standard specification, for example regarding the outer dimensions, it is also recorded here. If the original order specification is not available any more, please contact the Völker customer service.

1.3 Copyright protection

Providing a Third Party with the instructions for use is permissible only after prior written approval by the Völker AG. All the documents are protected by copyright laws.

Unless explicitly granted the right to do so, it is forbidden to pass on or duplicate any documents, also in parts, make use of them or communicate their contents. Violations against these regulations present an offence and oblige to damage compensation. We reserve all rights for exercising commercially protected privileges.

1.4 Warranty and liability

Within the bounds of the warranty obligations undertaken by the main contract, the Völker AG is liable for potential defects or omissions, excluding further claims. Compensation claims, no matter on which legal argument they are based, are excluded.

We reserve the right to technical changes within the bounds of further development of the hospital beds covered in this service manual.

We do not accept responsibility for damages and operational breakdowns which are caused by operating errors and non-compliance with these service instructions.

The accessories drawn do not necessarily correspond to the graphic illustrations.

2. Safety regulations

2.1 Explanation of symbols

Warning notice



Information marked by this symbol must absolutely be read and adhered to!



DC



AC



Device acc. to safety class II
(double protective insulation)



Type B device according to DIN EN
60601-1

These instructions for use shall provide practical information ensuring the safe use and maintenance of the bed in accordance with the regulations.

Everybody who is in charge of starting up, operating or servicing the bed must have these instructions for use to hand. In order to avoid operating errors and to ensure smooth operation of the bed, these notices must always be available to the nursing staff.

2.2 Testing the functional safety and condition of the bed

After carrying out maintenance work or repairs, the bed must be checked for its functional safety. Check whether the bed can be used in accordance with the specifications without any hazards for patients, users or any third party.

Performance control and technical check must be carried out at least once a year.

2.3 MPG §3, Section 1

The hospital bed may only be set up, operated and used according to its intended use to be in compliance with the regulations of the “Law for Medical Products” (MPG) and related statutory orders issued and the recognised rules of engineering as well as the regulations for industrial safety and the prevention for industrial accidents. A hospital bed **must not** be operated if it is defective and might put patients, nursing staff or any third party at risk.

The hospital bed may only be operated by persons who can guarantee workmanlike handling on account of their training or skills and experiences.

2.4 Intended use

Völker's hospital beds, model S 960-2, are intended for laying patients in sick rooms of hospitals, clinics and nursing homes.

Patients below the age of 12 years may only be bedded in the model S 960-2 hospital bed if the necessary safety measures, such as lateral grid protection covers, are used.

Any other use deviating from the intended use of the Völker hospital bed is excluded from potential liability.

2.5 Misuse

Misuse of the hospital bed may lead to potential dangers. These include, for example:

- improper operation of electric functions and uncontrolled positioning,
- using the hospital bed for children below the age of 12 years,
- operating the hospital bed by patients without prior introduction,
- simultaneously operating electric functions by different persons, continuously pressing the buttons,
- using electrical appliances at the bed which are not intended for it (subject to the due diligence of the operator),
- pulling at cords in order to move the bed,
- loosening electric connectors by pulling at the cord,
- using the bed on a sloping surface exceeding an inclination of 10 degrees (the bed's brake is designed for a maximum angle of tilt of 10 degrees),
- trying to move the bed, although the locking function is engaged,
- using the bed for ambulant services using a vehicle,
- overloading the bed beyond the specified safe load-bearing capacity.

2.6 Electromagnetic/electrostatic interferences

The S 960-2 hospital bed fulfils the EMV safety requirements (electromagnetic compatibility) according to the "Law for Medical Products" (MPG). It was tested to comply with the norm EN 60601-1-2.

2.7 Before initial start-up

Before initially putting the hospital bed into operation, these instructions for use must have been read in detail by the persons responsible for the nursing service.

Before the hospital bed is put into operation for the first time, a performance control must have been carried out.

Before the bed is put into operation, the nursing staff must have attended detailed training in the handling of the bed. In addition, it must be pointed to potential hazards which might occur in spite of properly operating of the bed.

2.8 Testing the functional safety and condition of the beds

Before the bed is used, the operator must satisfy himself/herself that the hospital bed is in proper condition and a safe use is guaranteed. This check is not only to be carried out prior to the first use but also during the current use of the bed. If necessary, the hospital bed has to be checked daily or with any change of shift in order to ensure that no one can be put at risk by its use. In order to reduce the maintenance of the bed to the necessary minimum level, the hospital bed should be cleaned, disinfected and tested as soon as possible after each use so that it can be used again immediately without any risk.

Please note that processing the bed in automatic treatment plants is contrary to this principle :

In case of a defective bed it may become necessary to provide the patient with an other hospital bed.

2.9 Position of the hospital bed



“Danger of falling out”

With unsupervised patients it is recommended to put the bed into its lowest position in order to minimize the risk of injury in case of the patient falling out of the bed. Otherwise it is a good idea to adjust the height of the bed in relation to the height of the patient.

2.10 Moving the bed



When moving the bed ensure that the mattress frame is in the lowest position and that back and leg section of the mattress frame are completely lowered. Also ensure that the mains power cable and power cut off unit is not dragged along the ground or run over.

2.11 Four castors central braking



“Attention! Risk of accidents”

Unless the bed is used for transport purposes, the castors must always be in parked condition, because the bed might be used by patients as a support when getting up or lying down. When the bed is not in parked condition, thus moving away, it may lead to the patient having a bad fall. After operating the central locking brake it must be checked whether the bed is actually fixed, that is whether the castors' brake is sufficiently engaged.

2.12 Height adjustment



“Danger of getting stuck between undercarriage and frame when the bed is lowered”

When the bed is adjusted it has to be ensured that no persons, limbs, bed linen or other objects are between the frame and undercarriage.

2.13 Assist rail – “Danger of getting stuck”

With patients whose physical or mental condition seems to make it necessary to use the assist rail in order to protect them against falling out of the bed, the following safety measures must be adhered to:

The assist rail may be used only by trained nursing staff.

Make sure that the assist rails – or parts thereof – are either completely folded up and locked or completely folded down.

It has to be ensured that the patient is not getting into touch with the assist rail elements when operating the electric lying surface adjustment. It is likewise important that no part of the body projects from the assist rail.

If assist rails are used for a child or a person whose mental condition appears to make it necessary to use such a device, it has to be ensured that the manual control unit is put out of their reach. In addition, it is recommended to use lateral grid protection covers.

If the above mentioned safety measures are ignored by the nursing staff, haematomas or other injuries might occur if patients get their hands, knees, fingers, feet, shins and hips caught.

2.14 Cleaning and disinfection

Dangers might occur by improper cleaning/disinfections of the bed.

2.15 Mattresses

To minimize risk of injury do not use bed with mattresses of any other size than the following. If you do not use a Völker mattress contact a dealer of your confidence.

Size of mattress	Size of mattress frame
88.5 x 200 x 12 cm	90 x 200 cm
88.5 x 220 x 12 cm	90 x 220 cm
98 x 200 x 12 cm	100 x 200 cm
98 x 220 x 12 cm	100 x 220 cm

2.16 Service/Maintenance

The S 960-2 only requires little maintenance. All flexible parts of the height adjustment unit, the lying surface drives and assist rail parts are provided with lifetime lubrication by the factory. When these parts are commonly used and cleaned, they will not have to be lubricated again. However, the manufacturer assumes that the hospital beds will be examined in regular intervals, at least once per year and detected damages like signs of wear and tear, loose bolts or breaks will be immediately removed. For further information please see the service manual.

Every person who is in charge of carrying out maintenance as well as services, must at least have read

the Safety Regulations

and

the Service Manual

and be qualified according to the requirements set out in MPBetreibV § 4 and 6.

In order to avoid errors und to ensure trouble-free operation of our hospital beds, these papers must always be available to the service staff.

Before starting maintenance work, the service manual and the instructions for use must be read in detail by the persons in charge for these services.

Every time the bed has not been used for a while a function control have to be done.

During the maintenance and technical control the following guidelines have to be strictly followed.

The electrical installation of the room must accord to the actual state of technology and the hospital bed have to be used as intended.

The brakes must be fully applied.

The hospital beds are not flameproof which is why they may be serviced only in an environment that is free of combustible substances.

Main points of the functional control :

- Visual inspection of all important components on damage, abnormal wear, forming and contamination.
- Function control of all adjustable functions before start-up, after longer disuse and relocation of the bed.

- Function control of the brakes (safety, arrest, freewheel)
- Function control of all drives (checking the whole adjustable range, limit switch)
- Check of all jacks, connectors and LED-covers (before cleaning) on damages, which may cause an intrusion of wetness.
- Check all cables (electric supply and internal cabling) on damages, correct cable route and correct connection of all contacts.



Always secede the battery from the bed during maintenance !



After maintenance (repair) it is absolute required to check the bed for functional safety. You have to check if the bed can be used without causing damages to the patients and employees.

Execution of the technical control :

1. Visual inspection

Check the parts of the frame on plastically deformations and/or wear. (e.g. all elements of the mattress frame (back-, sitting-, upper leg- and lower leg section), hub, lifting receiver, castors) .

2. Functional check of the safety frames

Check if the locking mechanism of the safety frame is working faultless and if deformations or wear are observable.

Check if the mandatory distances are adhered while the safety frame is under load.

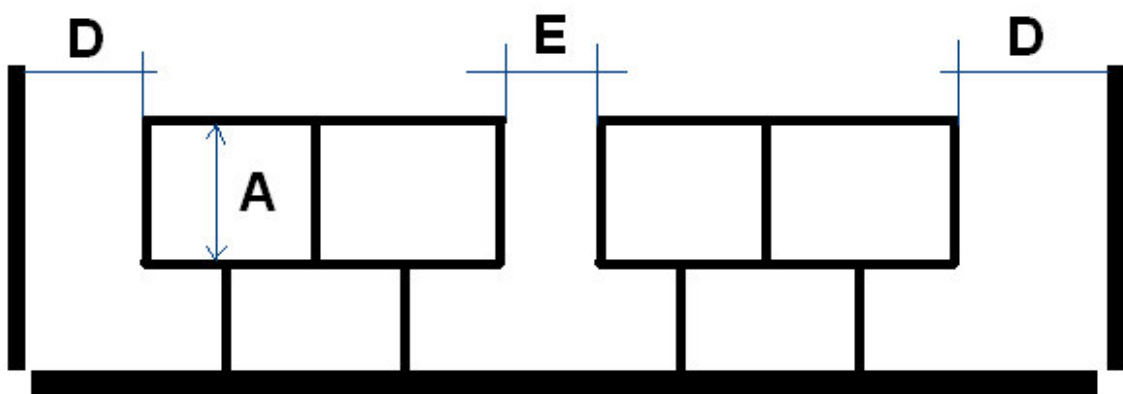

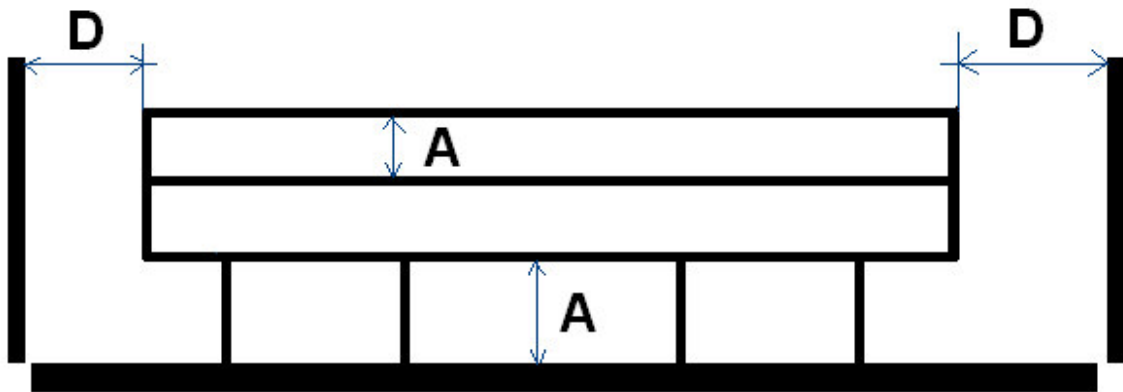

A* - The smallest dimension between elements inside of the perimeter of side rail in its raised/locked positions or perimeters created between the siderail and fixed parts of the bed

D* - Distance between head panel or foot panel and side rail

E* - Distance between segmented side rails with the mattress support platform in the flat position $\leq 60\text{mm}$ or $\geq 235\text{mm}$

During this checkup possible accessories like the middle disk for the safety frames have to be accounted.

3. Functional check brakes

Check the functional efficiency of the brakes (safety, arrest, freewheel).

4. functional check of the drives

Check the whole adjustable range of each drive. Pay attention to abnormal noises, the speed, smooth running etc. and that the selected function drives in the right direction. Especially pay attention to the fact that the drives stops singly when reaching its end position*.

*(The respective end position may vary dependant on the model of the bed. For further information pay attention to our technical technical specifications. If you have any questions please contact our service department.)

5. Electric supply

Check

- the electric supply cable including the grommet
- the cord grip including the bend protection mantle
- the main supply connector

on damages.

6. Cabling

Check the cable routing and the correct connection of the wrap connections on damages. Check the cables on damages.

7. Casing

Check all casings on damages. All screws have to be tightened. The seals must not show any signs of visible damage.

8. Mechanical inspection

Check the functional efficiency of the raster and (if existing) the pneumatic spring, by bringing the foot section manual in its different positions.

9. Battery (only S 960-2)

Change the 9V battery in a frequency of two years. Only use brands and dispose the old batteries in an environment-friendly way.

10. Measurement according to VDE 0751

The electrical inspection of the bed has to be carried out according to DIN VDE 0751-1 agreeable to the accident prevention regulation. You have to measure the leakage current. The legal limit amounts 0,5 mA.

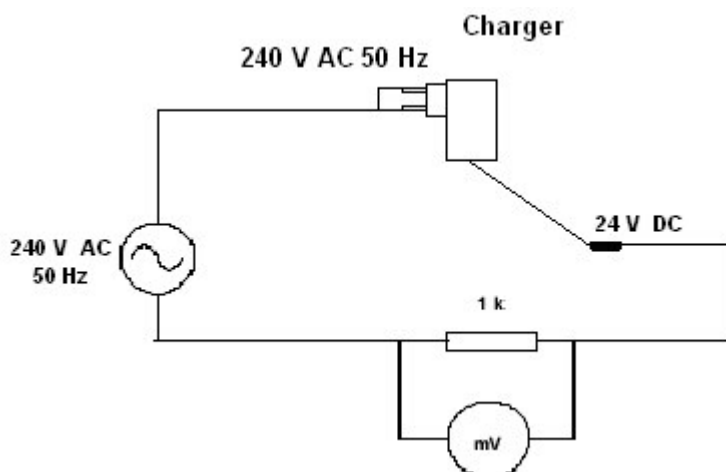

Furthermore you have to measure the impedance between the back-, sitting-, upper leg- and lower leg section and the potential equalisation connection. The impedance must be lesser than $0,3 \Omega$. ($I=5...25$ A, $R=U / I < 0,3 \text{ Ohm}$).

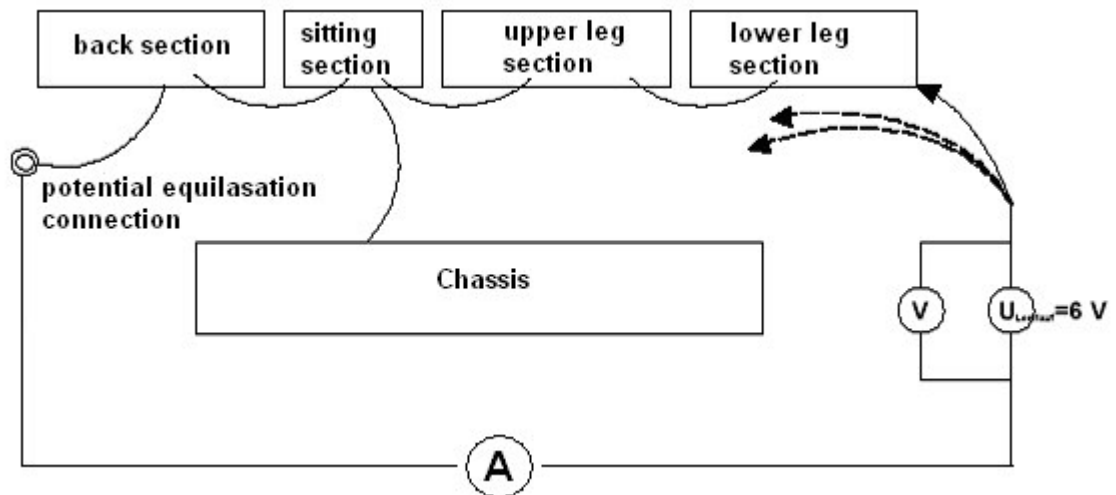



3. Technical specifications

3.1 Technical Data

Length	217 cm
Width	98 cm
Height, top edge head-/foot board	76.5 cm up to about 116.5 cm
Castors	4 , Ø 150 mm, 120 kg Tente, integral castors
Max. castor load	100 kg (dynamic)
Height adjustment range (dependent on the type of castor)	approx. 40 cm to 80 cm
Lifting range	40 cm
Mattress displacement	12 cm
Dead weight	142 kg
Safe working load	210 kg
Safe working load lifting receiver	75 kg
Safe working load infusion pillar	2 kg per clamp
Battery	Type 4x6 V Block battery (lead-gel), 1,2 Ah
Manual control unit	Völker
Double drive unit Okimat 480 for back section + upper leg +	Okin
lower leg section	Okin, single drive
Lifting gear motor	Okin
Mains voltage	AC 230, 110 V
Nominal current	0,8 A
Nominal frequency	50 to 60 Hz
Fuse	2,0 A
Temperature range, in operation	+ 10°C to + 40°C
Temperature range, in transport/storage	-20°C to +60°C
Relative humidity	30% to 75 %
Atmospheric pressure range	700 hPa to 1060 hPa

3.2 Classification

Protection against electric shock	Safety Category II or appliance with internal power source.	
Type of protection by encasement according to EN 60259	IP X4, unsuitable for mechanical decontamination	
Degree of protection of parts handled by users against electric shock according to DIN EN 60 601-1	Type B	
Degree of protection against explosive materials and compounds	The bed is not explosion-protected and may not be used in environments in which there are flammable anaesthetics or cleaning agents (see leaflet ZH 1/200 of professional association.	
MPG category	Class I	
Service cycle	Interval 1 min / 10 min Operational time max. 1 min. Shut-off time 10 min.	
Technical safety check	Once a year	

4. Explanations for the nursing service

This documentation contains information that is required for the normal use of Völker hospital beds.

Völker does not accept any warranty claims for damages, injuries or accidents which are based on negligence, carelessness or improper use. Culpability is of no importance here.

A basic introduction of the nursing staff into the operation of the bed takes place by Völker or their representatives as required by the customer.

Participation in such a training by the nursing staff can be certified using a form designed for this purpose, including the participant's name, date and signature which are confirmed by Völker.

The safety regulations contained in this documentation (especially in chapter 2) must be adhered to.

Following the described behaviour patterns will ensure the safety of staff and patient.

Functions designated as optional extras are available only with the correspondingly equipped beds.

5. General operating instructions

5.1 Power-on time

Maximum power-on time of the electromotive bed function is indicated on the bed (identification plate) or the technical data sheet with Int 1 min/10 min, meaning that each bed function can be operated uninterruptedly within 10 minutes / 1 minute.



If the maximum power-on time of 1 minute is exceeded several times or for a longer time period, this may lead to a failure of the electromotive drive due to safety advices being released. The bed is then to be shut down for 10 minutes!

A time delay function is integrated into the bed in order to prevent continuously changing button operations and movement operations by unintentionally touching a button for a short time. The operator must intentionally press and hold the function button. The bed function is then carried out with a time delay of 0.5 seconds.

5.2 Batteries

The batteries in the bed have an electric charge capacity which is equivalent to an operation of 4 lift and lying space adjustments with a work load of 210 kg. After that, the emergency functions (Trendelenburg/Antitrendelenburg) can still be carried out.



If the bed is positioned at its location without connecting the battery charger to it, energy consumption and self-discharge will lead to the discharge of the battery!

If batteries are totally discharged, they may be damaged to such a degree that early replacement becomes necessary!

In order to achieve a long battery life, proper handling of batteries and battery charger is absolutely necessary!

5.3 Safety device

The bed is provided with an electronic safety device preventing the drives from being overloaded. In case of an overload occurring, the bed will be automatically switched off.

5.4 Putting the bed into operation

Installation conditions

The bed is approved for the operation in dry rooms only (Technical Data Sheet). In order for the bed to be operated, a power supply and potential outlet, if necessary, is required in the location where the bed is installed.

The bed is mobile without auxiliary transport facilities.

The bed can be moved on solid grounds only. It is not permissible to drive the bed on uneven surfaces greater than 2 cm. The maximum carriageway's angle of inclination may be 10°.

The bed is delivered in complete condition and installed without dismantling transport devices.

5.5 Mechanical start-up

The provided head and foot parts have to be inserted into the corner joints of the bed frame.

5.6 Connecting the manual control unit

The manual control units have to be inserted into the provided jacks and to be screwed on.



In case of improper connection, wash plant capability cannot be guaranteed.



If the manual control unit is removed from the bed, the connection socket must be closed using the protective cap.

5.7 Applying the bed's brake



After each initial start-up or renewed start-up, the bed may be in a condition where the brake is not applied.

Operate the brake bow in order to apply the brake:

45° downward position to the bed's end – fully applied brake.

5.8 Electric start-up



Take care for the correct connection between the main power cut-off and the okin drive.



Be aware that improper use of the main power cut off can cause damage to the unit, resulting in the batteries being unable to receive charge.

Do not drop the main power cut off unit. Do not pull or exert excessive strain on any electrical cables or connections. Take care not to run over the mains power cable when moving the bed.

1. Connect the main power cut-off with a grounding receptacle.
2. Unlock the bed.
3. To put the hand control unit and the caregiver's console into operation, take care that the functions of the bed are not locked by the caregiver's console.
4. Check the state of charge of the battery.
(Press any key on the hand control unit, so that the charging of the battery will be activated)
5. Check all functions.
6. → **The bed is now ready for use.**

5.9 Using the battery pack

The battery pack (optional extra) enables mains-free operation of the bed for at least 10 switch-on cycles.

The LED lights up in three colours:

Green: Battery pack is connected to the mains. Charging cycle is on.

Orange: Battery pack is currently being charged. Bed should not be operated mains-free.

Red: HAZARDOUS RANGE. Battery pack must be charged. Bed cannot be operated mains-free.

All LEDs are off Battery pack is fully charged. Mains circuit breaker is activated. No current flows in standby mode.

If a beep sound is heard, the battery pack must be recharged. The beep sound becomes more forceful the more the battery pack has been discharged. The battery pack will be switched off shortly before total discharge. After the bed has been connected to the mains, press any button at the manual control unit in order to make it fully functioning again. The battery pack is charged when it is connected to the mains after each use or when the charge has dropped too far.



If the bed is not connected to the mains for a longer period, the battery pack can become discharged. The level of discharge is dependent on the ambient conditions.



During the charge cycles the battery pack is connected to the mains, thus being supplied with electricity. The LED shows the charge state of the battery pack during the charge cycle. The circuit breaker is disabled, with electric current flowing to the bed.



If electromagnetic disturbances occur in the bed's environment, please refrain from operating these appliances.

In case of transport, the device must always be treated carefully and protected against humidity.



The device is specified for an ambient temperature of 10°C to 40°C, for a relative air humidity of 30% to 40% and for a barometric pressure of 700 to 1,060 hPa.



There is no maintenance required for the battery pack. Replacement of the battery pack may only be carried out by trained personnel of the Völker AG.

If the battery pack is faulty, this may lead to gas emissions of the same. This can be recognized by deformations of the battery pack case. In this case, please immediately put the bed out of operation and contact customer service at once!



The battery pack must be disposed of at suitable facilities to be compatible with the environment, or you are welcome to return it to the Völker AG.

In order to put the manual control unit and the personnel keyboard into operation after switching on the bed, the locking of the function keys must be released.

- performance control

→ Bed is now ready for use.

5.10 Operating the assist rails

In order to set up an assist rail part, pull the assist rail horizontally to the side as far as it will go and fold it up.

In order to adjust the height of the assist rail, pull the telescopic part upward as far as it will go.

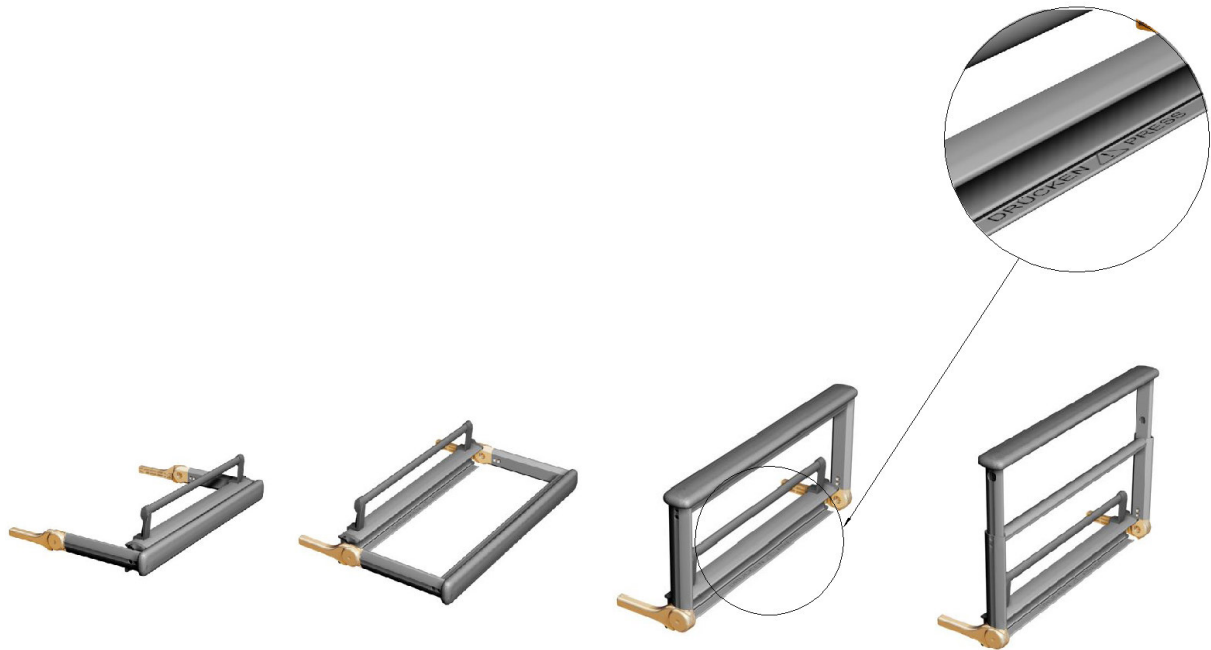

In order to completely fold down an assist rail part, press both buttons on the exterior surface of the frame, right above the cross bar, so that the height-adjustable guard part can be put into its lowest position.

Operate the release button labelled "Push" at the bottom of the assist rail part and tilt it horizontally to the side so that it runs parallel to the floor.

Push the assist rail completely under the lying surface.

One or more assist rail parts can be inserted as required in order to safeguard the bed user.

Folding up all the four assist rails provides the user of the bed with maximum protection.



Because of their exceptional stability, the assist rail parts can also be used to deposit bed linen (maximum 15 kg) or as an additional support surface for clinically desired bearings as, for example, carrying out physiotherapeutic treatment.



Warning: All people who are responsible for handling the assist rails must read and comply with the following information:

When operating the back, upper leg or lower leg adjustment, the lift or assist rails, it is vital to ensure that the patient neither gets into contact with the assist rail nor any part of the body is jutting out the assist rail.

If assist rails are used for a child or a person whose mental condition appears to make it necessary to use such a device, it has to be ensured that the manual control unit is stored beyond their reach. If the manual control unit is installed in a place where the patient can reach it, an exact healthcare documentation must be kept according to the rules (it must always be taken care of that no health hazards may occur).

Protection covers for the assist rails are available as an accessory, providing additional protection against injuries through the contact with assist rails. It is recommended to use these protection covers with all persons where there is a high risk of injuries caused by unavoidable contacts with the assist rails. This, however, does not relieve the caregiver or patient from exercising reasonable care when operating the bed.

When using assist rails, they must either be always led completely upward, so they will click into place, or be put into bottom location as far as they will go.

The assist rails should always be held at the respective section ends using both hands and guided to the top/bottom.

5.11 Life expectancy / disposal

The average life expectancy of the hospital bed is approx. 10 years. To guarantee an environment-friendly disposal after putting the bed out of service, please contact your representative-in-charge.

6. Control functions

6.1 Functional overview of the caregiver`s console

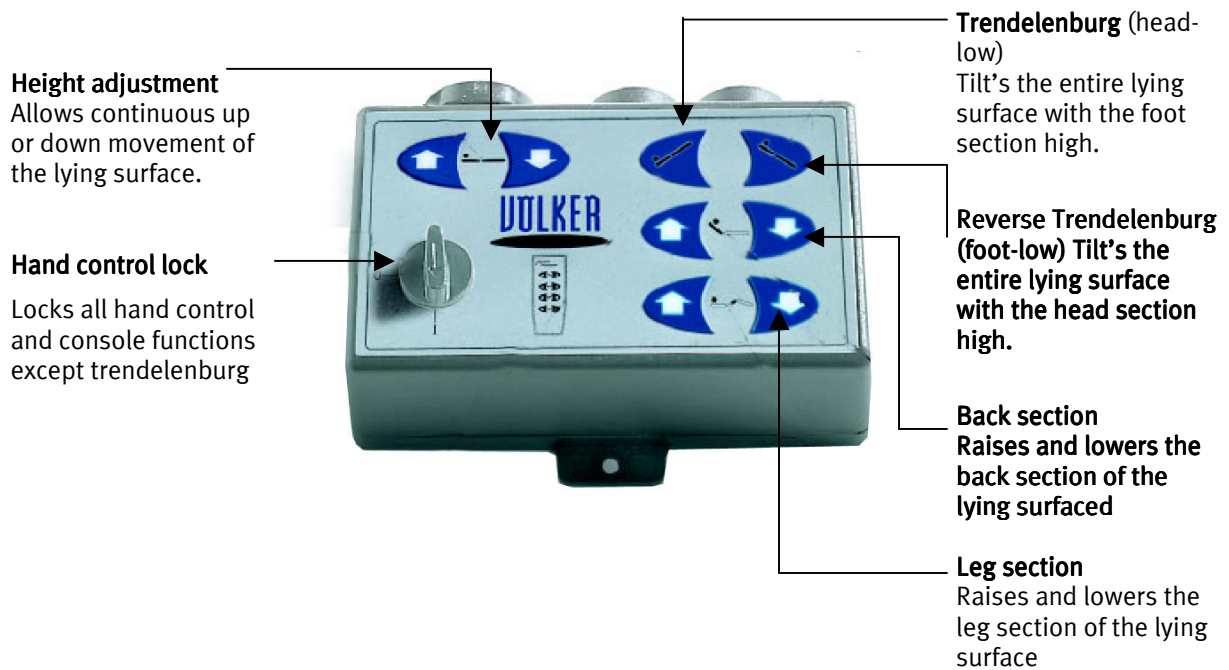

6.2 Functional overview of the manual control unit

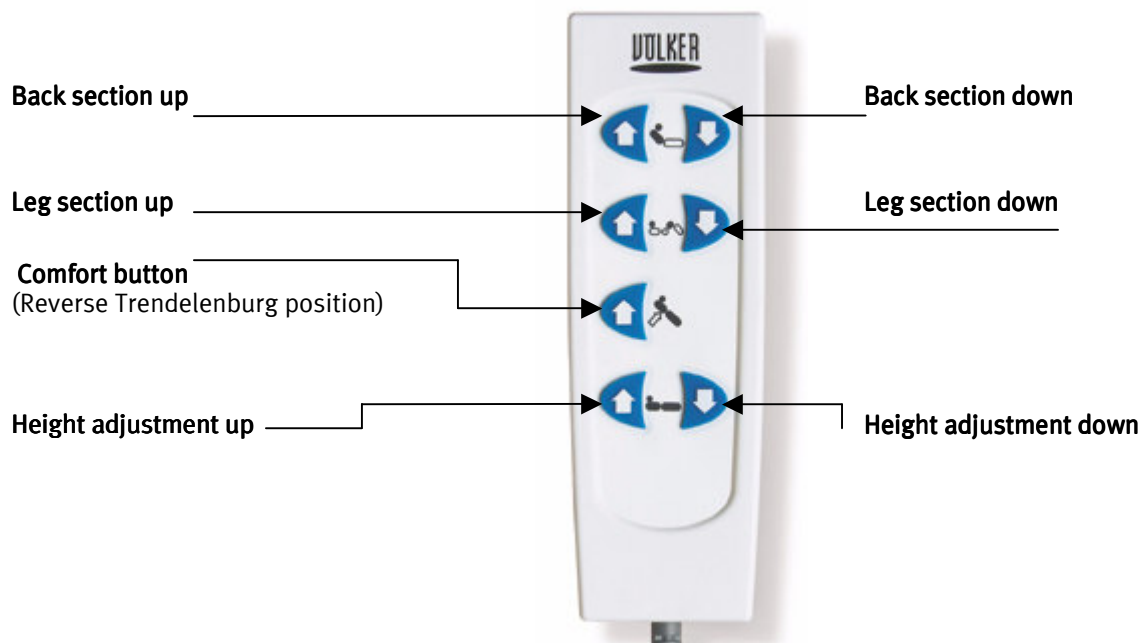

6.3 Functional overview of the personel keyboard

Optional the S 960-2 hospital bed can be delivered with a personel keyboard which is integrated in the foot section.

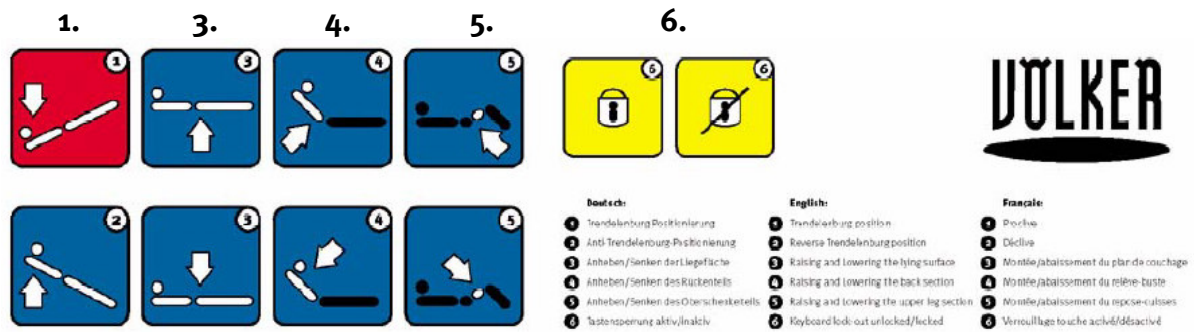

1. **Trendelenburg** - (head-low) Tilt's the entire lying surface with the foot section high.
2. **Reverse Trendelenburg** – (foot-low) Tilt's the entire lying surface with the head section high.
3. **Height adjustment** – Allows continuous up or down movement of the lying surface.
4. **Back section** - Raises and lowers the back section of the lying surfaced
5. **Leg section** - Raises and lowers the leg section of the lying surface
6. **Hand control lock** - Locks all hand control and console functions except trendelenburg

7. Electric functions

7.1 Back section adjustment

The back section can be adjusted by means of the manual control unit or the caregiver's console.

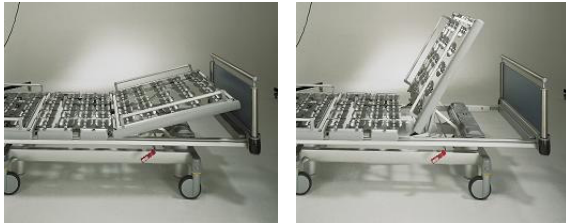

The corresponding buttons are as follows:

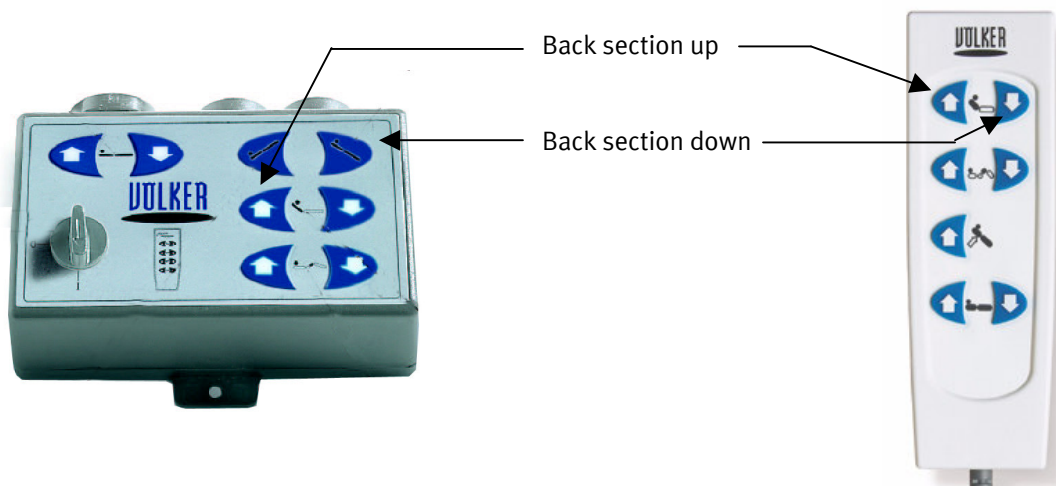

If necessary, unlock the back section using the caregiver's console.

The back section of the lying surface can be set up to an angle of tilt of up to 70 degrees.

When the back section is raised, it will be displaced by a maximum of 150 mm towards the bed-head. This way, the lying comfort is increased, since the patient is stopped from sliding down the bed.



Warning: When the back section is raised, with the assist rails being folded up, it has to be ensured that neither parts of the patient's nor any other person's body protect from or lie on the assist rail!

7.2 Leg section adjustment



The leg section can be adjusted by means of the manual control unit or the caregiver`s console. The corresponding buttons are as follows:

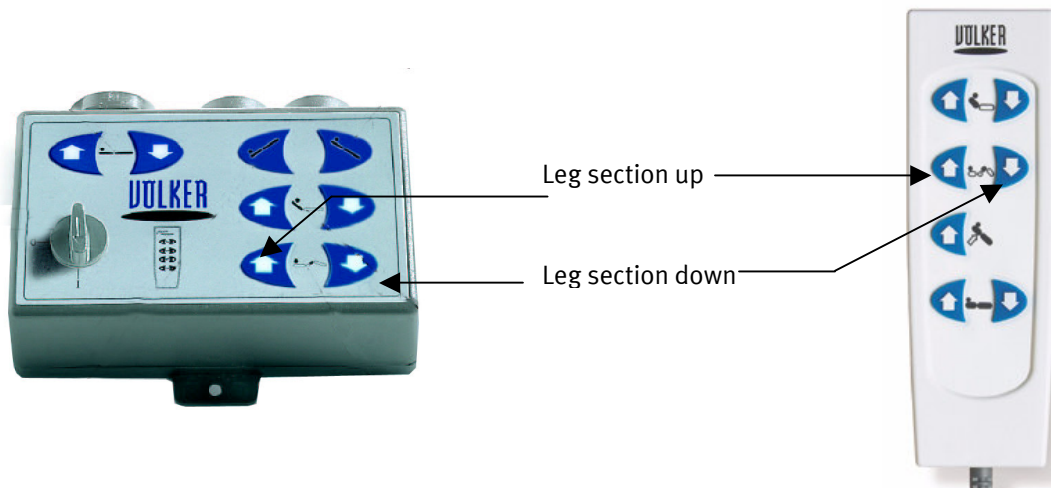

If necessary, unlock the leg section using the supervisor control box.

The leg section of the lying surface can be set up to an angle of tilt of up to 62 degrees.



Warning: When the leg section is raised, with the assist rails being folded up, it has to be ensured that neither parts of the patient`s nor any other person`s body protect from or lie on the assist rail!

7.3 Bed height adjustment



The entire lying surface can be adjusted by means of the manual control unit or the supervisor control box. The corresponding buttons are as follows:

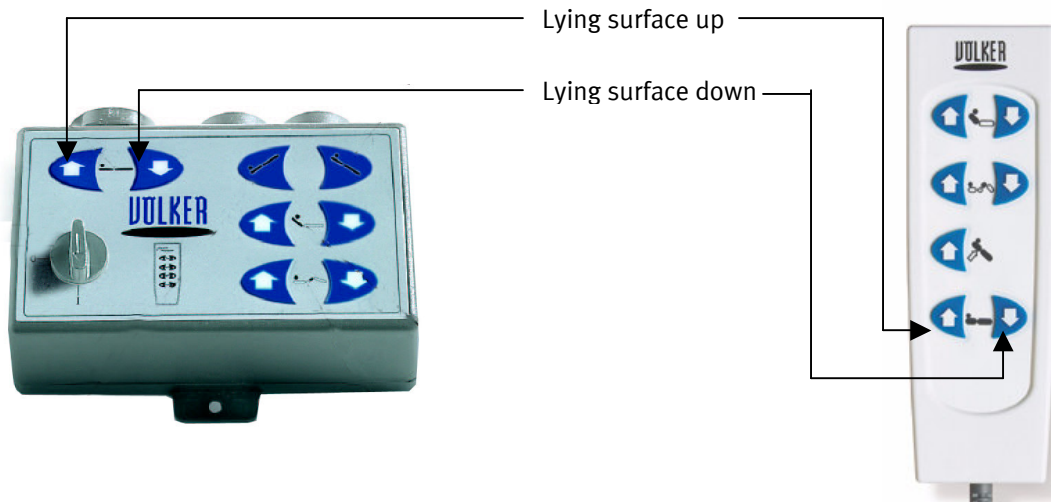

If necessary, unlock the height adjustment using the supervisor control box.



Warning: We recommend to lower the bed as far as it will go in order to prevent the patient from any danger caused by falling out of the bed!



Warning: Before lowering the bed, it must be ensured that no persons, limbs or bed linen are between the lying surface and the undercarriage. Before any one gets into and out of the bed, it has to be ensured that the bed stands firmly on the ground (castors in parked position)!



Warning: When the height adjustment is operated, with the assist rail being folded up, it has to be ensured that the patient neither gets into contact with the assist rails nor his or any other person's parts of the body project from the assist rail!

7.4 Trendelenburg/Anti-Trendelenburg bearing



The Trendelenburg/Anti-Trendelenburg bearing functions can only be adjusted by means of the caregiver's console.

The corresponding buttons are as follows:

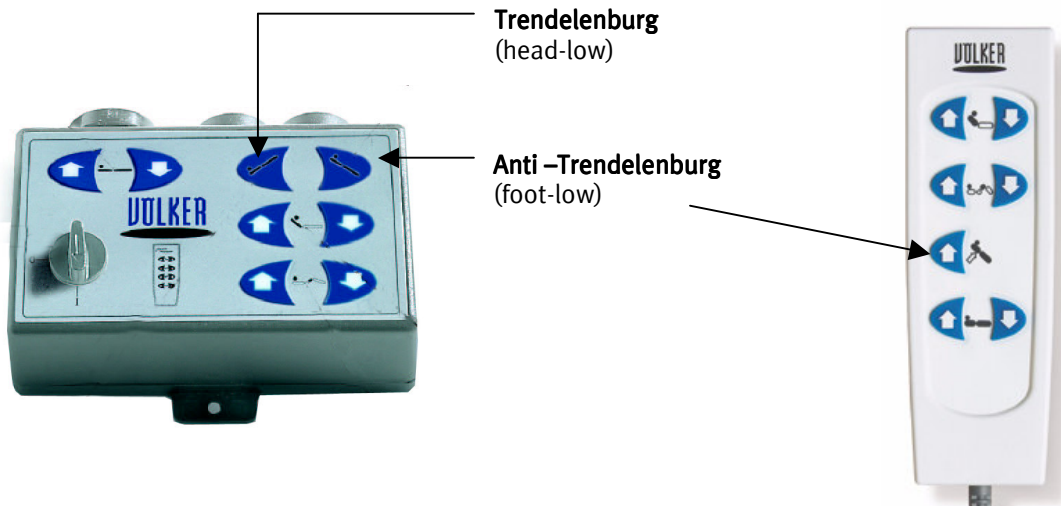

NOTE: Only the lying surface inclination is adjusted – the lying surface remains in the set position!



In case an error occurs with the lifting function or there is no connection to the mains supply or the battery is completely dead, the Trendelenburg function cannot be executed any more. If necessary, the patient must then be moved to another bed!

As long as the batteries have a residual voltage, the function will still be available.



After locking the lifting function, the Trendelenburg/Anti-Trendelenburg function will not be locked!

7.5 Hand control lock

By activating the hand control lock, you lock all functions on the hand control and the caregiver's console, excepted the keys for Trendelenburg and Anti-trendelenburg.

If you can not use a function of the bed, please check if the keys are locked by the caregiver's console.



Activating / deactivating the hand control lock



Warning :

When the height adjustment is operated, with the assist rail being folded up, it has to ensured that the patient neither gets into contact with the assist rails nor his or any other person's parts of the body project from the assist rail!



Warning :

Please note that it is absolutely necessary to lock all functions of the bed by the caregivers, when the patient is endangered strongly in a physical or psychological way.

8. Trouble shooting

The following table contains notes on potential malfunctions. The causes for such failures may be improper use or wear and tear. These malfunctions may lead to injuries of patients and staff.



Before carrying out any trouble shooting ensure that the battery is charged (during the charging process, the yellow LED is flashing in intervals according to the charge state) and the bed is connected to the mains supply (power plug inserted to an outlet which is live).

Before starting any repair work make sure to disconnect the bed from the mains supply and to separate the battery pack from the circuit, if necessary.

Diagnosis	Possible cause	Trouble shooting
Bed does not function at all	<ul style="list-style-type: none"> - Plug not inserted or outlet is not live - Battery is not connected or dead - Mains connection relay got stuck - Entire drive unit is faulty - Power cable is damaged 	<ol style="list-style-type: none"> (1) Insert plug or check outlet (2) Press green button of the mains connection while simultaneously operating any function of the manual control unit (3) Check battery and replace it, if necessary (4) If there is no fixed cable link to the motor, replace the power cable
Lifting/lowering function of the lying surface is faulty	<ul style="list-style-type: none"> - Lying surface motor is faulty - Manual control unit is defective - Mattress retraction lever is faulty - Slider for mattress compensation is defective - Bearing support for slider/bolt is faulty 	<ol style="list-style-type: none"> (1) Replace the respective drive (2) Replace manual control unit (3) Replace mattress retraction lever (4) Replace slider for mattress compensation (5) Replace bearing support for slider/bolt
Height adjustment is faulty – bed height cannot be adjusted	<ul style="list-style-type: none"> - Manual control unit is defective - Lift is locked / drive is faulty - supervisor is defective 	<ol style="list-style-type: none"> (1) Replace manual control unit (2) Replace the respective drive (3) Replace supervisor /unlock lift
Height adjustment is faulty – bed can be adjusted on one side only	<ul style="list-style-type: none"> - Drive is defective - Cable harness running to functioning motor is faulty - Signal transmitter at the functioning side is defective - Limit switch is maladjusted (at the functioning side) 	<ol style="list-style-type: none"> (1) Replace the drive (2) Replace the cable harness (3) Replace control motor (4) Adjust limit switch
Bed can hardly be moved	<ul style="list-style-type: none"> - Castor is faulty - Directional roll is defective 	<ol style="list-style-type: none"> (1) Replace castor (2) Replace directional roll

9. Spare parts

Please take the name as well as the order number of the required component from the chapter “Presentation of Assemblies” in your service manual.

10. Cleaning and disinfection

10.1 Wipe disinfection

The wipe disinfectants listed in the DGHM List of 01.07.1994 (Deutsche Gesellschaft für Hygiene und Mikrobiologie = “German Society for Hygiene and Microbiology”) can be used in the concentrations recommended in the relevant manufacturer’s instructions.

- **Wooden parts** may **not** get into contact with the relevant cleaning agent.
- The use of solvents is **not** permitted.
- **Do not use** abrasive cleaners, scouring pads or similar cleaning aids.
- **Do not use** organic solvents such as halogenated/aromatic hydrocarbons and ketone.

Depending on the degree of contamination we advise that the bed is cleaned with a damp cloth or similar.

Follow these instructions when using cleaning agents and/or disinfectants:

- Decontamination solutions in the prescribed concentrations may **not** exceed or fall below a pH-value of 6- 8.
- They may **not** contain any corrosive or caustic substances.
- They may **not** contain substances that alter the characteristics of surface or the properties of plastic or synthetic materials.
- They may **not** affect the properties of lubricants.
- Water hardness may **not** exceed 0.9 mmol/l (to 5° d).
- (Fully desalinated water may **not** be used.)

Chloride	< 100 ppm
Silicate as SiO ₂	< 15 ppm
Iron	< 0.05 ppm
Manganese	< 0.01 ppm
Copper	< 0.05 ppm

This information reflects the current state of our knowledge and experience. It does not exonerate users from carrying out their own tests and trials as conditions (e.g. water hardness) differ locally. No legally binding guarantee of any kind is granted or can be assumed.

We accept **no liability** for possible damage to surfaces arising from the use of unsuitable cleaning agents or disinfectants, from the use of incorrect concentrations or from the unsatisfactory care of the bed.

**Electric shock / fire hazards and functional deficiency**

Generally, the bed has to be cleaned and disinfected, with the battery charger disconnected from the bed.

The plug and socket of the manual control unit are waterproof only if they are in plugged-in condition. If the plug is taken off, both units are not waterproof so that the plug has to be protected against penetrating water. The socket must be closed using the cap.

10.2 Spray lances

Cleaning and disinfecting the bed using spray lances of high-pressure cleaning apparatuses is not permitted.

11. List of tools

Ring spanner WS 17, WS 13

Open-end spanner WS 13, WS 10

Set of angled screw drivers

Set of Torx Bits

Set of cross recess Bits

12. Service points

If required, please contact the responsible person in your sales organisation. You will then immediately receive all necessary information on the comprehensive service.

13. Accessoires

Völker supplies an extensive range of easy-to-fit accessories to achieve the greatest possible flexibility. The hospital beds are equipped with holding fixtures for accessories like drip-feed holders, grab-handles or bed lamps so that you can extend the functional scope of your bed.

In addition mattresses, lamps as well as an extensive programme of bedside cabinets and servers, tables, chairs, easy chairs and cupboards are available to match Völker hospital beds. Please ask for our information brochures.

13.1. Usage of fixation systems

The use of fixation systems like belts is only allowed in observance of the regulations of the producer.

When using fixation systems the safety frames must be completely raised.



It is not allowed to move the mattress frame during a fixation.

The mattress frame have to be in the lowest possible position.

Deactivate all functions of the mattress frame during a fixation and keep the manual control unit out of range of the patient

14. Forms

This is an example for ordering spare parts for your hospital bed:

The identification plate and the model name of your bed are located at the inner side of the head part.

Please note down the data on the order form.

By using the “Bed Data” menu item, the following information is shown in the display:

ID number

Hardware version

Software version

Please note down the data on the purchase order form.

Please locate the desired spare parts in the respective illustration.

Please enter the order numbers according to the indications given in the tables:

Quantity

Item number

Part designations

Völker AG

Wullener Feld 79

58454 Witten

GERMANY

Fax: +49-(0)2302-96096-66

Place and date

Company/stamp of the hospital

Signature

ID number:	
See identification plate	
See display (bed data)	
Model	
Hardware version: See display (bed data)	
Software version: See display (bed data)	

1. Contact person: _____

2. Phone number: _____

Purchase order:

	Number of pieces	Order number	Name
1			
2			
3			
4			
5			
6			
7			
8			
9			
10			
11			
12			
13			
14			
15			
16			

Technische Überprüfung S960-2

Identifikations-Nr.			
Prüfung		In Ordnung	Kommentar
Sichtprüfungen:			
Funktionsprüfung:	Untergestell/ Teleskopsäule		
	Liegefläche		
	Notabsenkung CPR-Funktion		
	Aufrichteraufnahme		
	Netzanschlussleitung Bett		
	Netzteil		
	Netzanschlusstecker		
	Kabelverlegung innerhalb des Bettes		
	Sitz der Verschraubungen		
	Gehäuse der Antriebseinheit / Akku- Box		
	Handschalterkabel		
	Handschaltergehäuse		
Seitengitter	Verriegelung		
	Verformung		
	Verschleiß		
Kopf-und Fußteile	Verschleiß		
Bremse			
Rollen Antriebe	Liegeflächenmotoren		
	Untergestell-Motoren		
	Gleichlauf HUB		
	Endschalter		

Überprüfung des Zubehörs (Aufrichter, Seitensicherung mit Teleskop, Mittelsicherung...):

Ergebnis der Funktionsprüfung :

In Ordnung

Nicht in Ordnung

Unterschrift:

Datum:

Konformitätserklärung /

Declaration of Conformity / Déclaration de conformité

Konformitätserklärung Anhang VII EU-Richtlinie 93/42/EWG

Der Unterzeichnende
Völker AG
Wullener Feld 79
58454 Witten

bestätigt, dass die nachfolgend bezeichneten Produkte in der von uns in Verkehr gebrachten Ausführung die grundlegenden Anforderungen des Anhangs I der EU-Richtlinie 93/42/EWG erfüllen. Es wurden die folgenden Normen angewendet :
DIN EN 60601-1,
DIN EN 60601-1-2,
DIN EN 60601-1-4,
DIN EN 60601-2-38.

Damit sind die Anforderungen des Medizinproduktegesetzes zur Anbringung einer CE Kennzeichnung erfüllt.

Bei einer nicht mit dem Hersteller abgestimmten Änderung des Produktes verliert diese Konformitätserklärung ihre Gültigkeit.

Bezeichnung der Produkte :
Klinikbetten S 960-1 und S 960-2.

EG-Richtlinien :
Richtlinie 93/42/EWG vom 14.06.1993 über Medizinprodukte (Anhang I „Grundlegende Anforderungen“). Die Produkte sind Produkte der Klasse I gemäß Anhang VII des Medizinproduktegesetzes MPG vom 02.08.1994

Declaration of conformity Appendix VII EU Directive 93/42/EEC

The signatory
Völker AG
Wullener Feld 79
58454 Witten/Germany

confirms that the products described below and in the form distributed by ourselves meet the basic requirements of Appendix I of EU Directive 93/42/EEC.
The following standards are applied :
DIN EN 60601-1,
DIN EN 60601-1-2,
DIN EN 60601-1-4,
DIN EN 60601-2-38.

The requirements of the medical products law pertaining to the display of a CE seal of approval are thereby fulfilled.

This declaration of conformity becomes invalid if the products are altered without the agreement of the manufacturer.

Description of products Type/Article No.:
Hospital beds S 960-1 and S 960-2.

EU Directives :
Directive 93/42/EEC of 14.06.1993 concerning medical products (Appendix I, Basic requirements). The design and construction of this product conforms to Class I (Appendix VII) Medical products law (MPG) of 02.08.1994.

Déclaration de conformité Annexe VII Directive EU 93/42/CEE

La soussignée
Völker AG
Wullener Feld 79
58454 Witten/Allemagne

confirme que les produits spécifiés ci-dessous sont conformes, dans le modèle mis en circulation, aux exigences fondamentales de L'annexe L de la directive européenne 93/42/CEE.
Les standards suivants sont appliqués :
DIN EN 60601-1,
DIN EN 60601-1-2,
DIN EN 60601-1-4,
DIN EN 60601-2-38.

Les exigences de la loi sur les produits médicaux concernant le port de la marque CE sont ainsi satisfaites.

Cette déclaration de conformité est invalidée en cas de modification des produits, non autorisée par le fabricant.

Désignation des produits
Modèle/Référence :
Lits hospitaliers S 960-1 et S 960-2.

Directives européennes :
Directive 93/42/CEE du 14.06.1993 sur les produits médicaux (annexe I « Exigences fondamentales »). La conception du produit est conforme à la classe I (annexe VII). Loi sur les produits médicaux (MPG) du 02.08.1994.

Witten 23.06.03



ppa. Heinrich Völker

Vorstandsvorsitzender / Executive board (chair) / Directoire (Président)

Guidance and manufacturer’s declaration – electromagnetic emission for all equipment AND systems (see 6.8.3.201 a) 3))		
The S960-2 is intended for use in the electromagnetic environment specified below. The customer or the user of the S960-2 should assure that it is used in such an environment.		
Emissions test	Compliance	Electromagnetic environment - guidance
Harmonic emissions IEC 61000-3-2	Class A	The S960-2 is suitable for use in all establishments, including domestic establishments and those directly connected to the public low-voltage power supply network that supplies buildings used for domestic purposes.
Voltage fluctuations / flicker emissions IEC 61000-3-3	Complies	
RF emissions CISPR 14 – 1	Complies	The S960-2 is not suitable for interconnection with other equipment.

Guidance and manufacturer's declaration – electromagnetic immunity for all equipment and systems (see 6.8.3.201 a) 6))

The S960-2 is intended for use in the electromagnetic environment specified below. The customer or the user of the S960-2 should assure that it is used in such an environment.

Immunity test	IEC 60601 test level	Compliance level	Electromagnetic environment - guidance
Electrostatic discharge (ESD) IEC 61000-4-2	± 6 kV contact ± 8 kV air	± 6 kV contact ± 8 kV air	Floors should be wood, concrete or ceramic tile. If floors are covered with synthetic material, the relative humidity should be at least 30 %.
Electrostatic transient / burst IEC 61000-4-4	± 2 kV for power supply lines ± 1 kV for input/output lines	± 2 kV for power supply lines Not applicable!	Mains power quality should be that of a typical commercial or hospital environment.
Surge IEC 61000-4-5	± 1 kV differential mode ± 2 kV common mode	± 1 kV differential mode Not applicable!	Mains power quality should be that of a typical commercial or hospital environment.
Voltage dips, short interruptions and voltage variations on power supply input lines IEC 61000-4-11	< 5 % U_T (→95 % dip in U_T) for 0,5 cycle 40 % U_T (60 % dip in U_T) for 5 cycles 70 % U_T (30 % dip in U_T) for 25 cycles < 5 % U_T (→95 % dip in U_T) for 5 sec	< 5 % U_T (→95 % dip in U_T) for 0,5 cycle 40 % U_T (60 % dip in U_T) for 5 cycles 70 % U_T (30 % dip in U_T) for 25 cycles < 5 % U_T (→95 % dip in U_T) for 5 sec	Mains power quality should be that of a typical commercial or hospital environment. If the user of the S960-2 requires continued operation during power mains interruptions, it is recommended that the S960-2 be powered from an uninterruptible power supply or a battery.
Power frequency (50/60 Hz) magnetic field IEC 61000-4-8	3 A/m	3 A/m	Power frequency magnetic fields should be at levels characteristic of a typical location in a typical commercial or hospital environment.

NOTE U_T is the a. c. mains voltage prior to application of the test level.

**Guidance and manufacturer’s declaration – electromagnetic immunity
for EQUIPMENT and SYSTEM that are not LIFE-SUPPORTING (see 6.8.3.201 b))**

The S960-2 is intended for use in the electromagnetic environment specified below. The customer or the user of the S960-2 should assure that it is used in such an environment.

Immunity test	IEC 60601 test level	Compliance level	Electromagnetic environment - guidance
Conducted RF IEC 61000-4-6	3 Vrms 150 kHz to 80 MHz	3 V	Portable and mobile RF communications equipment should be used no closer to any part of the S960-2, including cables, than the recommended separation distance calculated from the equation applicable to the frequency of the transmitter. Recommended separation distance $d = 1,17\sqrt{P}$
Conducted RF IEC 61000-4-3	3 V/m 80 MHz to 2,5 GHz	3 V/m	$d = 1,17\sqrt{P}$ 80 MHz to 800 MHz $d = 2,33\sqrt{P}$ 800 MHz to 2,5 GHz where P is the maximum output power rating of the transmitter in watts (W) according to the transmitter manufacturer and d is the recommended separation distance in metres (m). ^b Field strengths from fixed RF transmitters, as determined by an electromagnetic site survey, ^a should be less than the compliance level in each frequency range. ^b Interference may occur in the vicinity of equipment marked with the following symbol: 

NOTE 1 At 80 MHz and 800 MHz, the higher frequency range applies.

NOTE 2 These guidelines may not apply in all situations. Electromagnetic is affected by absorption and reflection from structures, objects and people.

^a Field strengths from fixed transmitters, such as base stations for radio (cellular/cordless) telephones and land mobile radios, amateur radio, AM and FM radio broadcast and TV broadcast cannot be predicted theoretically with accuracy. To assess the electromagnetic environment due to fixed RF transmitters, an electromagnetic site survey should be considered. If the measured field strength in the location in which the S960-2 is used exceeds the applicable RF compliance level above, the S960-2 should be observed to verify normal operation. If abnormal performance is observed, additional measures may be necessary, such as reorienting or relocating the S960-2.

^b Over the frequency range 150 kHz to 80 MHz, field strengths should be less than 3 V/m.

Recommended separation distances between portable and mobile RF communications equipment and the equipment or systems - for equipment and systems that are not life-supporting (see 6.8.3.201 b))

The S960-2 is intended for use in an electromagnetic environment in which radiated RF disturbances are controlled. The customer or the user of the S960-2 can help prevent electromagnetic interference by maintaining a minimum distance between portable and mobile RF communications equipment (transmitters) and the S960-2 as recommended below, according to the maximum output power of the communications equipment.

Rated maximum output of transmitter W	Separation distance according to frequency of transmitter m		
	150 kHz to 80 MHz $d = 1,17\sqrt{P}$	80 MHz to 800 MHz $d = 1,17\sqrt{P}$	800 MHz to 2,5 GHz $d = 2,33\sqrt{P}$
0,01	0,12	0,12	0,23
0,1	0,37	0,37	0,74
1	1,17	1,17	2,33
10	3,69	3,69	7,38
100	11,67	11,67	23,33

For transmitters rated at a maximum output power not listed above the recommended separation distance d in metres (m) can be estimated using the equation applicable to the frequency of the transmitter, where P is the maximum output power rating of the transmitter in watts (W) according to the transmitter manufacturer.

NOTE 1 At 80 MHz and 800 MHz, the separation distance for the higher frequency range applies.

NOTE 2 These guidelines may not apply in all situations. Electromagnetic propagation is affected by absorption and reflection from structures, objects and people.

