

# VÖLKER



Instructions for use  
5384



# Version, Imprint

**Instructions for use G155  
HB-RD-000055 Rev.3**

**Völker Bed 5384**

**from year of construction 03/2016**

**These instructions for use are  
valid from 05/2021**

© by Völker GmbH

Manufacturer:

Völker GmbH

Wullener Feld 79, 58454 Witten

GERMANY

Tel.: +49 2302 96096-0

Fax: +49 2302 96096-16

e-Mail: [info@voelker.de](mailto:info@voelker.de)

Internet: [www.voelker.de](http://www.voelker.de)



All rights reserved.

Reprinting - whether in full or in part - is not permitted.

We reserve the right to make changes due to technical developments.

The contents of this document are subject to change without prior notice.

Customers are advised to contact the relevant person before placing an order.

Technical documentation can be made available on request.

For the electronic version of these instructions for use in PDF format, visit [www.voelker.de](http://www.voelker.de).

# Table of contents 1/2

Version, Imprint	3	Activation	Operation   Hand control	
Table of contents	4	General operating instructions	Adjusting the back section	44
Notes   General information	6	Activation   Preparation	Operation   Hand control	
Notes   Designated purpose	7	Activation   Electrical activation	Adjusting the lying surface height	45
Notes   General regulations, user training / instruction, further requirements	9	Activation   Use of the battery	Operation   Hand control	
Notes   General safety notes	10	Activation   Functional check	Setting the aid for getting out of bed	46
Functional description   Overview of Style model	15	Operation   Guide castors	Operation   Hand control   Saving the lying surface height position	47
Functional description   Overview of Select model	16	Operation   Side rails   General safety notes	Operation   Hand control	
Functional description   Manoeuvrable version	17	Operation   Continuous side rails - Style model	Setting the Anti-Trendelenburg position	48
Functional description   Hand control E2486	18	Operation   Divided side rails - Select model	Operation   Hand control	
Functional description   Accessories	19	Operation   Hand control	Setting the Trendelenburg position	49
Securing systems	24	Hand control lock   Keeping safe	Operation   Hand control	
Functional description   Versions and Options	25	Operation   Hand control	Setting the position "Easy chair"	50
		Adjusting the upper leg section	Operation   Hand control	
		Operation   Hand control	Setting the position "Flat and horizontal"	51
		Adjusting the lower leg section (manually)	Operation   Hand control	
			Under-bed light	52
			Operation   Hand control	
			Functions of the enable button	53

## Table of contents 2/2

Operation   Rapid lowering of the back section / CPR function	54	Information on electromagnetic compatibility (EMC)	79
Operation   Dynamic bed extension	55	Forms	80
Cleaning and disinfection	56	Available accessories	82
Maintenance   Staff training, safety notes	58		
Maintenance   Maintenance schedule	59		
Technical checks	60		
Troubleshooting   Table of faults	62		
Symbols used	65		
Technical data (standard design)	67		
Classification	69		
Type labels	70		
Service life / disposal	72		
Dimension sheet for divided side rails	72		
Dimension sheet for continuous rails	74		
Manufacturer's declarations	75		

## General information

You have purchased a bed from Völker GmbH. This bed has been built in accordance with the applicable national and international standards and regulations reflecting the current state of technology.

Völker beds satisfy requirements in terms of safety and functionality. They are tested in accordance with international standards and bear the CE mark, which documents the beds' compliance with essential requirements for medical products (DIN EN 60601-1 and DIN EN 60601-2-52).

Please read the general safety notes. Please observe (with particular attention to any warranty claims) the further instructions on the following pages.

## Variants

The bed can be designed in different variants. A description of these variants can be found in the "Versions" section.

You can also find information on different operating variants or different technical data for the models at various points in these instructions for use. You can recognise the variant of your bed based on the type label.

## Standard design

The standard design of the bed can be supplied with various options. A description of these options can be found in the "Versions and Options" section.

## Copyright protection

These instructions for use may only be transferred to third parties with the written consent of Völker GmbH. All documents are protected under the Copyright Act.

## Guarantee and liability

Völker beds are supplied with a comprehensive guarantee that is described in detail in the order confirmation. For more extensive information please contact Völker.

We reserve the right to make technical modifications without notice as part of the further development of the beds which form the subject of these instructions for use.

All specifications are non binding. Printing errors are reserved.

We accept no liability for damage and operational faults caused as a result of misuse and/or non-observance of these instructions for use.

The portrayal of the accessories does not necessarily match the actual product.

# Notes | Designated purpose 1/2

## Intended use

The Völker beds 5384 are beds for medical use and are intended for the laying down and care of adult occupants/patients in care institutions and retirement homes (Application environment 3\* as per DIN EN 60601-2-52).

The operator shall consider the patient's mental and physical condition and the resulting risks to the operation of this medical device before using the bed.

The application environment 3 involves long-term care in a medical sector in which medical surveillance is required and supervision is provided if necessary. This includes retirement and nursing homes, rehabilitation facilities and geriatric facilities.

The bed may only be operated under the conditions described in these instructions for use. Any other use is considered improper.

The safe working load of the bed is 230 kg. To calculate the maximum patient weight, DIN EN 60601-2-52:2010 stipulates subtracting from the safe

working load, when using the bed in application environment 3, 20 kg for the weight of the mattress and 15 kg for accessories as well as the load that is borne by the accessories.

The safe working load and the maximum patient weight can be taken from the following table:

Model	Safe working load of the bed	Maximum patient weight
5384	230 kg	195 kg

Any use of the Völker bed extending beyond this intended use is excluded from a potential liability.

## Contraindications

This bed is only suitable for patients whose body size and weight are above the following minimum requirements:

Height: 146 cm

Body weight: 40 kg

Body Mass

Index (BMI): 17

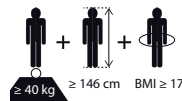

The Body Mass Index is an index value derived from body weight and height.

The BMI is calculated from the formula:

$$\text{BMI} = \frac{\text{Body weight}}{\text{Height}^2} \quad \left[ \frac{\text{kg}}{\text{m}^2} \right]$$

## Side effects

If the patient lies down for a longer period of time, pressure ulcers can occur without appropriate countermeasures.

\* Except in the vicinity of high-frequency surgical equipment and in rooms containing magnetic resonance imaging (MRI) equipment.

## Notes | Designated purpose 2/2

### Inappropriate use

Inappropriate use can be dangerous.

This includes, but is not limited to:

- Incorrect actuation of electrical functions and uncontrolled positioning
- Operation of the bed by the occupant/patient without having received prior instruction in how to do so
- Use of other electrical equipment on the bed
- Pulling on cables to move the bed
- Removing electrical plug connections by pulling on the cable
- Use of the bed on a slope of more than six degrees of inclination (the bed's brakes are designed for an angle of inclination of no more than ten degrees)

- Any attempt to move the bed while it is in braked position
- Use of the bed to transport people
- Use of the bed for transport within a vehicle
- Overloading of the bed beyond the specified safe working load

 **CAUTION** If it is impossible to avoid accommodating persons under 146 cm in height in the beds, the protective covers for the side rails must be used. This also applies when the bed is used by weak or confused persons.

 **WARNING** The bed may not be placed right next to or stacked up with other equipment. Should the operation be near to or stacked up with other equipment be necessary, then it must be ensured that the operation of the bed is observed, and correct use in this arrangement is checked.



# Notes | General regulations, user training / instruction, further requirements

## General Requirements

The bed must only be operated and used in accordance with its designated purpose, in line with the applicable conditions, the generally acknowledged rules of technology and the occupational safety and accident prevention guidelines. The bed must not be operated in a faulty state that could endanger its occupant/patient, care personnel or third parties.

## User training

The bed may only be operated by individuals whose training or understanding and experience offer surety for correct handling.

## User instruction

The thorough induction of care personnel in the operation of the bed can be provided by Völker or its representatives at the customer's request. Attendance of such training can be certified and confirmed by Völker using the

form provided for this purpose, specifying the name, date and signature. Occupants/patients must be instructed in the use of the bed before care personnel can hand over control to them.

## Other requirements

Whoever is in charge of the activation, operation or preparation of the bed must have been given a copy of these instructions for use (in printed or electronic form) and have read them.

To avoid operating errors and to safeguard the smooth operation of the bed, care personnel must always have access to the safety notes below.

## Flooring requirements

Increasingly overweight patients and occupants have caused a consistent increase in demands on hospital and healthcare beds in recent years. Völker has addressed this topic by increasing the "safe working load" for the beds. The higher strain requirements are not

limited to beds only, they apply also to static and floor requirements.

For this reason, we recommend that flooring designed for these loads is used in areas where the beds are situated. This means flooring that is classified in accordance with DIN EN ISO 10874 and that has been laid by professionals (flooring for public or commercial areas that are subject to medium or heavy traffic).

## Notes | General safety notes 1/5



**Warning symbols**  
Information marked with this symbol must always be read and strictly observed.



**CAUTION** represents potentially dangerous situations that can cause slight physical injuries.



**DANGER** represents an immediate threat of danger that will cause serious physical injury or death.



**WARNING** represents potentially dangerous situations that can lead to serious physical injury or death.



**NOTE** warns of potential damage to objects or property.

### Before first activation

Care personnel must read these instructions for use carefully and in full before the bed is activated for the first time.

Before the bed is activated, care personnel must be instructed in the handling of the bed using the instructions for use. In addition, the potential risks which may arise despite the proper operation of the bed must also be pointed out in full.

### Before and during use

Before each use of the bed, the user must be sure that the bed is in a proper condition and that safe use is ensured.



**WARNING** To avoid injury from falls, we recommend always moving the bed to its lowest position with the castors fixed when the patient is sleeping in the bed (except when undertaking care measures).



**WARNING** If other devices are operated on the bed, which are provided with cables, air hoses or similar, make sure that these lines are routed so that they cannot become jammed in the moving parts of the bed or be damaged.

### Position of the bed





**CAUTION** To avoid injury from falls, we recommend always moving the bed to its lowest position with the castors fixed when the patient is sleeping in the bed (except when undertaking care measures).

### Transporting the bed

-  **CAUTION** The bed is not designed for transporting people. When moving the bed, it must always be ensured that the main connection cable does not touch the ground and that the lying surface height is at least 35 cm.
- The bed should only be moved over a solid surface.
- Never attempt to push it over obstacles of over 1 cm in height.
- The maximum angle of inclination of the floor must not exceed 6°.

### Securing the bed

-  **CAUTION "Risk of accident"**
- If the bed is not moved, the guide castors must always be fixed and latched into place, if necessary, since the bed may be required as a support for when the occupant/patient stands up or lies down. If the bed rolls away without the castors being braked, this can lead to a serious fall.
- Once the castors have been applied, check that the bed is actually properly parked.
- The bed sometimes finds itself in an unbraked position after each activation or reactivation and must therefore be checked subsequently to ensure the castors are fixed properly.
-  **NOTE** Please note that the brakes are most effective only on dry, clean and slip-resistant flooring.

### One-sided load on the bed

-  **NOTE** In order to prevent one-sided loads on the bed, it must not be used as a seat for persons other than the occupant/patient (i.e. visitors must not sit on the edge of the bed).

### Side rails

-  **WARNING "Risk of entrapment"**
- In the case of occupants/patients whose physical or mental condition makes it necessary to use side rails to protect them from falling out of bed, the following safety measures must be observed:
- The legal permissibility of using side rails must be ascertained.
  - The side rails may only be operated by trained care personnel.
  - It must be ensured that the occupant/patient does not come into contact with the side rail

## Notes | General safety notes 3/5

elements upon activation of the electrical lying surface adjustment. It is also important to ensure that no part of the body is sticking out through the side rails.

- Ensure that the side rails (or parts thereof) are either fully raised and locked in position or completely lowered.
- If the side rails are used with a person whose psychological condition makes their use necessary, then it must be ensured that the hand control is kept out of his/her reach or its functions are locked. It is also strongly recommended that side rail protection covers are used.

 **DANGER** If these safety measures are not observed by care personnel, injuries can be caused to hands, knees, fingers, feet, legs and hips, along with haematomas and other injuries as a result of entrapment.

With children or people who are less than 146 cm tall, non-observance of these guidelines can lead to death!

### Height adjustment

 **DANGER "Risk of entrapment between the lower frame and/or floor and the bed frame when the bed is lowered"**

It must be ensured that no people, limbs, pets, bed linen or other objects are caught between the bed frame and the lower frame and/or floor during adjustment.

 **DANGER "Danger of movement"** If any movement of the bed could represent a danger to the occupant /patient, all functions must be locked.

### Accessories

 **WARNING "Risk of injury"**

Only original Völker accessories should be used! Third-party accessories must undergo testing by the operator before use.

### Use of lifting devices

The lifting devices specified are appliances that can be attached to the bed for transport purposes. Patient lifters can be used.

 **WARNING "Risk of injury"** No lifting device must be fastened directly to the bed (patient transport, repair).

## Notes | General safety notes 4/5

### Use of oxygen equipment



#### **DANGER "Risk of fire"**

Never use the bed in an oxygen tent or in potentially explosive atmospheres (where flammable gases or vapours are present).

Provided it has been excluded (e.g. based on information in the instructions for use of the equipment being used) that the use of the equipment or a fault may cause the O<sub>2</sub> concentration to rise to such a degree that there is an explosion risk, then the equipment can be used.

### Rail infill panels

When using the rail infill panel, please read the separate instructions for use for this accessory. During technical checks, the rail infill panels should also be checked to ensure they are suitable for the size of side rail used.

### Cleaning and disinfection

In order to maintain consistent functioning, the bed should be cleaned, disin-

fectured and tested as soon as possible following each use, so that it can be reused immediately without risk.

Incorrect cleaning/disinfection of the bed can cause danger.

### Maintenance and repair

Anyone responsible for carrying out maintenance and repair work must at least have received instruction from Völker in the service tools, have read the safety notes and the service manual and be qualified in accordance with the law on medical products § 4.

After maintenance work or repairs have been carried out, a technical check must be carried out on the affected parts and/or functions  71.

During this check, it must be determined whether the bed can be used in accordance with the specifications without risk to the occupant/patient, user or a third party.

A technical check must be carried out at least once a year and after every lengthy period of non-use.

Any discernible damage, such as signs of wear and tear, loose screws or breaks/fractures must be eliminated immediately.

### Electromagnetic and electrostatic interferences

The beds in model series 5384 satisfy the EMC\* requirements in accordance with the law on medical products (MPG). The basis for testing is standard EN 60601-1-2.

\* Law concerning the Electromagnetic Compatibility of Operating Equipment

## Notes | General safety notes 5/5

### Serious incidents

Any serious incidents that occur in conjunction with operation of the bed must be reported immediately to the appropriate authorities in the relevant country and to Völker GmbH.

### Applied parts

Applied parts are parts of a medical electrical device (ME device) that necessarily come into physical contact with the patient under normal conditions of use so that the ME device or an ME system can fulfil its function (DIN EN 60601-1).

For the S 966 hospital bed, these are:

- Hand control unit
- Side rails
- Head/foot ends
- Lying surfaces
- Frame

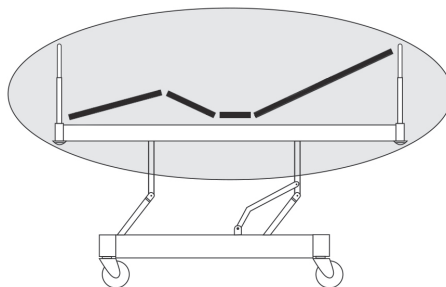

Schematic representation of the application area.

## Functional description | Overview of Style model

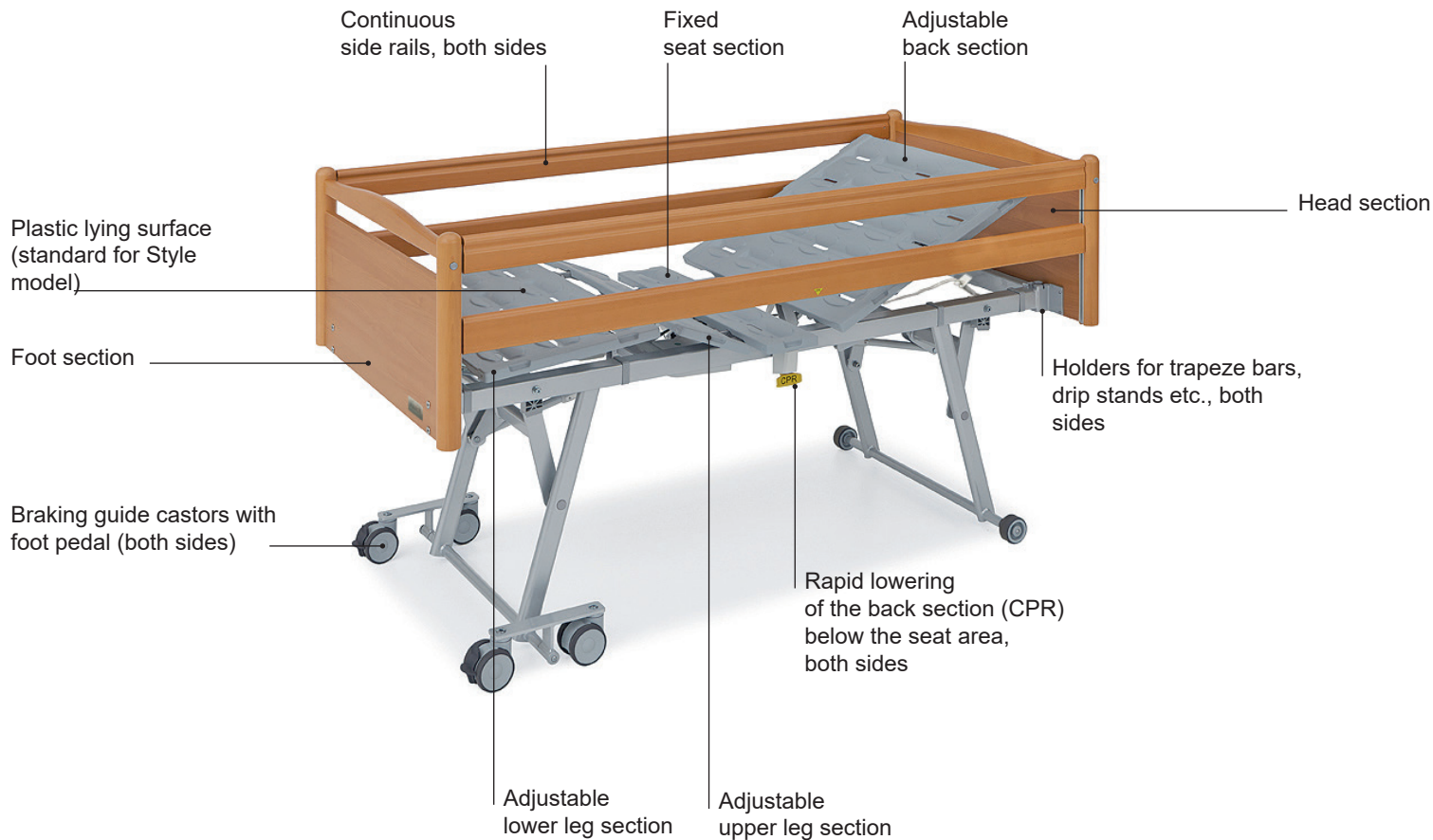

## Functional description | Overview of Select model

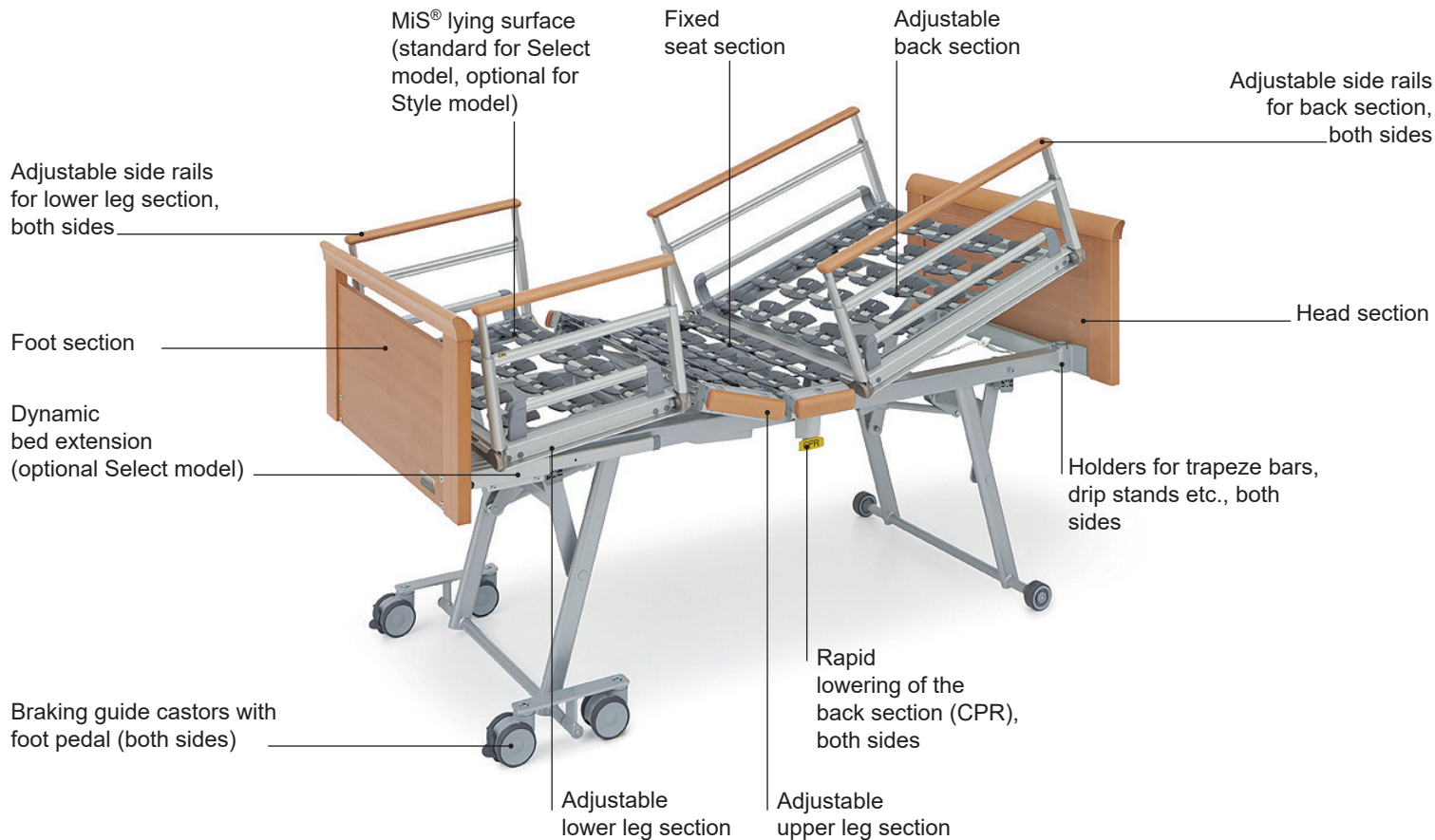



## Functional description | Manoeuvrable version

The manoeuvrable version of both models is fitted with two steering castors at both the head and foot ends.

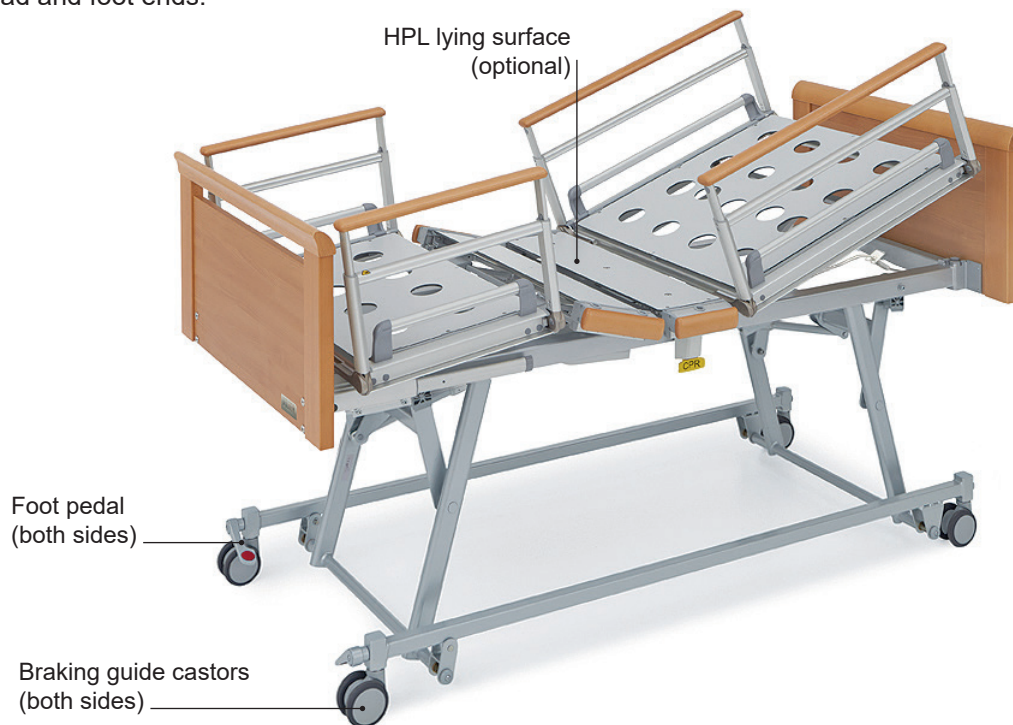

## Functional description | Hand control E2486

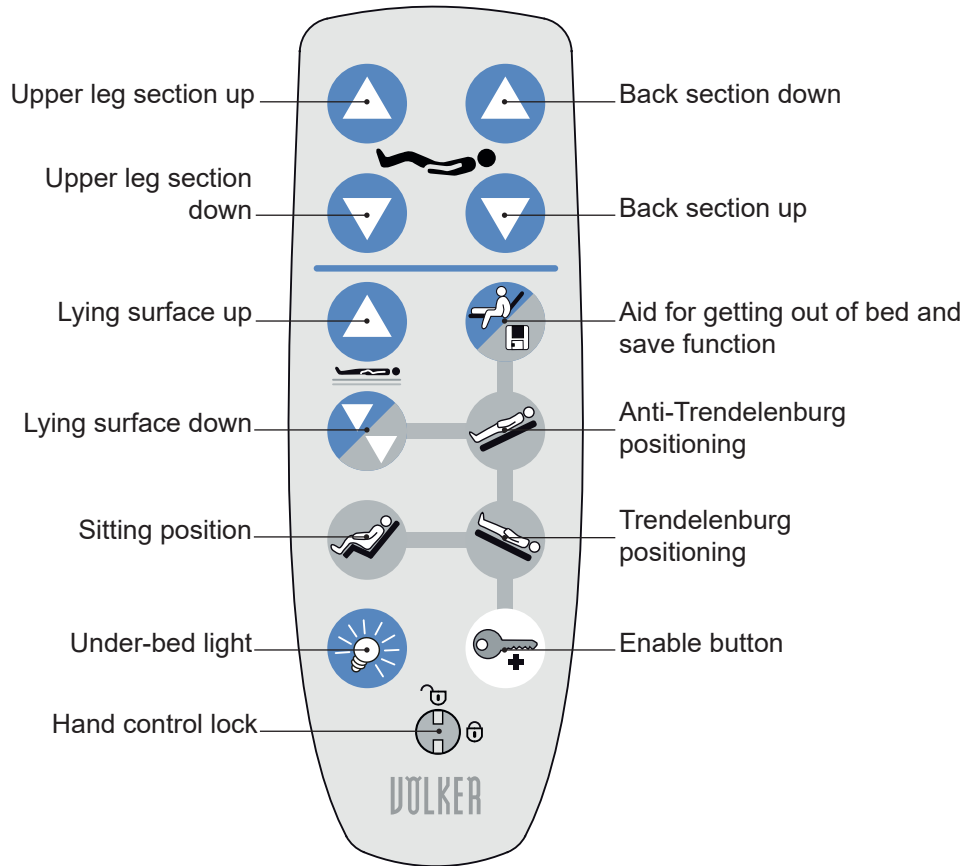

**⚠ WARNING** When actuating motorised adjustments with the side rails raised, ensure that the occupant/patient does not have any contact with the side rails. Ensure that no parts of his or her body, or those of other people, are sticking through the side rails or are trapped between the lying surface and the lower frame and/or floor!

## Functional description | Accessories 1/6 Mattresses

### Mattresses

To offer the greatest degree of flexibility, Völker offers a wide range of easy-to-attach accessories. The beds are equipped as standard with holder devices for accessories, such as drip stands and trapeze bars.

You can find further information regarding the accessories in our current information brochures or on the Internet at [www.voelker.de](http://www.voelker.de). Our staff will happily inform you about available accessories for your bed model.

To minimise the risk of injury, please only use Völker mattresses with dimensions that match the Völker lying surfaces.

**⚠ WARNING** Only original Völker accessories may be used!

**⚠ DANGER** If mattresses are used that do not match these specifications, there is a risk of suffocation!

Please read the relevant instructions for use before using the mattresses.

**💡 NOTE** Air-filled mattresses are **not** compatible with dynamic bed extension!

Ensure that the mattresses are placed on the bed, aligned with the lying surface and securely attached as specified in the regulations.

The tubes and cables of the air-filled mattress must be positioned in such a way that they are not kinked, squashed or otherwise damaged by the moving parts of the bed.

To reduce the length of the power cable, the mattress system should be connected to the nearest possible socket so that the cable does not lie on the floor.

Before transporting the beds, the cables and tubes of the air-filled mattresses must be secured to the bed so that they are not damaged during transport, e.g. by rolling over.

Cables and tubes of the air-filled mat-

tresses must be checked regularly for damage.

Mattresses with damaged cables and/or tubes may not be used!



Typical representation for Völker mattress NP50 Monodensity.

## Functional description | Accessories 2/6 Mattresses

**⚠ DANGER** The height of the raised side rail above the foam mattress must always be greater than or equal to 220 mm; otherwise the occupant/patient may accidentally fall out of bed. Please note that the height of the mattress has a direct influence on this.

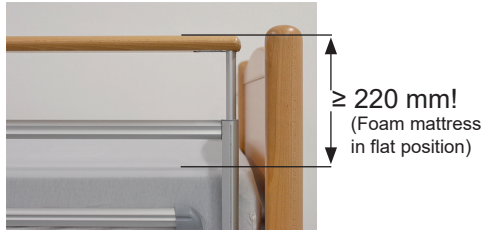

## Functional description | Accessories 3/6 Trapeze bar and accessory holders

Holders for the trapeze bar and accessories are located on the inside of the head panel. The trapeze bar and other accessories must slide into the holders until you hear them click into place.



Trapeze bar holders  $\varnothing$  34.2 mm



The trapeze bar is inserted into the holder and latched into place.

**⚠ WARNING** Only use the the trapeze bars listed in the accessories list!

**⚠ WARNING "Risk of Injury"**  
Ensure that the trapeze bar is completely slotted into the holder and securely seated. Please note: The safe working load of the trapeze bar is maximum 75 kg.

**⚠ WARNING "Risk of falling"**  
The trapeze bar must not be used by the occupant/patient as a means for climbing into or out of the bed. The trapeze bar must never jut out beyond the outer edge of the bed and then be used as an aid to pull oneself up (e.g. when getting out of a wheelchair).

**⚠ WARNING "Risk of injury"**  
The trapeze bar may not be used by the patient/occupant without supervision.



Similar pictures

## Functional description | Accessories 4/6 Trapeze bar and accessory holders

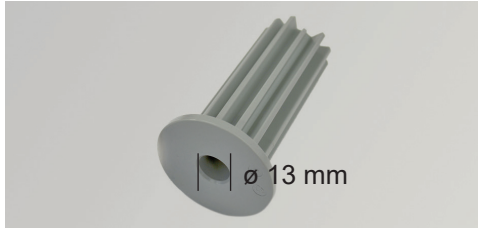

The trapeze bar holders can be provided with an adapter (ø 13 mm) for a drip stand or for other accessories.



The adapter is inserted into one of the trapeze bar holders.



The drip stand or the accessory is fastened from below with a sleeve nut.

**⚠ WARNING** The drip stand must always be aligned towards the bed, as shown below, and may not point outwards.

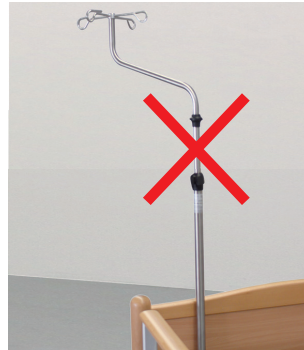

**⚠ WARNING** Should the bed be moved or adjusted, the infusion tubing or cables must be closely monitored by the care personnel.

Please also note that drainage devices are able to touch the floor when lowering the bed. This also applies for the Anti-Trendelenburg and Trendelenburg position.

## Functional description | Accessories 5/6 Securing systems - Rail infill panels

The rail infill panels close the middle gap between the divided side rails on Völker beds so as to enable a continuous side rail solution.



**⚠ WARNING** Make sure that the side rails are fully set up and latched into place. When activating the electric lying surface adjustment or side rails, it must be ensured that the patient/occupant has neither contact with the side rails, nor any part of the body protrudes through the side rails. We strongly recommend that you lock the functions of the hand control.

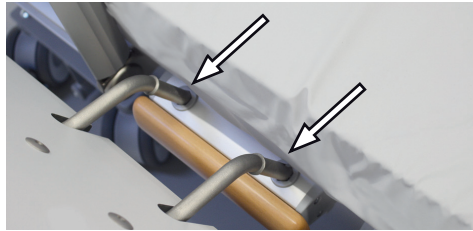

The rail infill panels are inserted in the insertion sleeves of the upper leg section.

Check whether the pendulum locking is completely latched into place by attempting to pull out the rail infill panel upwards. If you succeed in doing this, press the rail infill panel fully down again and adjust the pendulum until the rail infill panel can no longer be pulled out.



To remove the rail infill panel from the holder, move the pendulum into a vertical position and pull the rail infill panel up and out at the same time.

**⚠ NOTE** Please observe the detailed instructions for use for the rail infill panels.

## Functional description | Accessories 6/6 Securing systems

### Use of securing systems

Securing systems such as belts should only be used exactly as specified by the manufacturer.

If securing systems in the form of abdominal belts are used, then it must be ensured that the side rails are completely raised. The gap in the middle of the rails must always be closed using a rail infill panel with the Select model.

Devices for safeguarding patients may not be regarded as a substitute for the requisite supervision of the patient/occupant by the care personnel.

Even if fastened correctly, means of safeguarding patients can become tangled and injure the patient/occupant or even cause the death of the patient/occupant if the latter is agitated and confused.

When using safeguarding devices, the patient/occupant must be supervised corresponding to the statutory regulations and the applicable protocol of the facility. Failure to observe this note can lead to personal injury or material damage.

**⚠ DANGER** When using securing systems and rail infill panels, please note the separate instructions for use pertaining to these accessories.

If the patient is restrained with the help of restraint holders (optional for both models), the lying surfaces must never be adjusted while the patient is restrained and must always be in the lowest position!

The lying surface adjustment functions must be locked when a patient is restrained, and the hand control must be kept out of the reach of the occupant/patient!

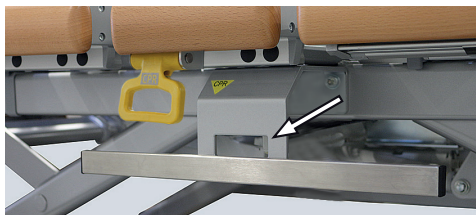

Restraint holder



## Functional description | Versions and Options 1/3

These instructions for use cover all of the versions and options listed. Precise information on the bed versions supplied can be found in the order specifications for your bed.

If the original bed specification is no longer available, please contact the Völker Customer Services.

Please make a note of the serial number (ID No.) on the type label before you call.

### Wall protector wheels

Vertical wall protector wheels are optionally available for both models.



### Linen holder

A pull-out linen holder at the foot of the bed is optionally available for both models.



The linen holder should always be pushed in to avoid causing damage when not in use.

**⚠ WARNING** The linen holder may not be used as a seat or step! The safe working load of the linen holder is 20 kg.

### Accessories rail

An accessories rail is readily available for both models as an extra option.

**💡 NOTE** If the lying surface is lowered below 35 cm, any object that has been attached on the accessories rail must be removed!

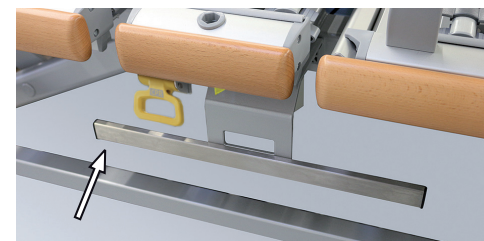

### Under-bed light

A under-bed light is available as an option for Style model.



## Functional description | Versions and Options 2/3

### MiS® lying surface

Völker MiS® is a support system where the different elements register and promote the occupant's/patient's own movement.

Thanks to the large number of contact points, the occupant/patient is supported in an anatomically correct manner, which also has a positive influence on sleeping behavior.



### HPL lying surface

The four-part HPL lying surface (HPL = high-pressure laminate) consists of moisture-resistant high-pressure laminate.

The four elements are well ventilated via the round cut-outs, are individually removable and fulfil the highest hygienic requirements.

The HPL lying surfaces can be easily removed and can therefore be cleaned quickly and thoroughly. They also facilitate the use of therapy mattresses.



### Dynamic bed extension

The Select model can be equipped with a telescopic bed extension. Extension: approx. 28 cm.

An additional mattress extension (PA2215) must be used when using the dynamic bed extension.



### Battery

A battery is available for both bed models as an option.

The battery allows the bed to be operated independent of the power supply for at least two adjustment cycles under full load.

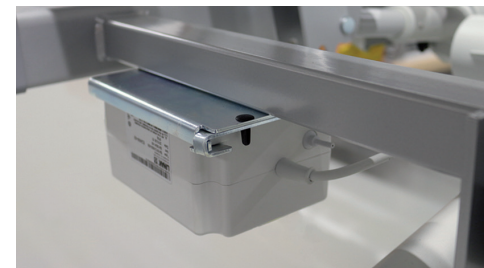

### Variants divided sidesails

Select model is available with the following siderail variants:



Extendable 34 - 35,5\* cm (standard)

Extendable 43,5 - 45\* cm (option)

\* Dimensions are from the upper edge of the siderail to the lying surface (without mattress). The different extension heights are dependent on the lying surface (HPL or MiS®), see also p. 86 - 87.

# Functional description | Versions and Options 3/3

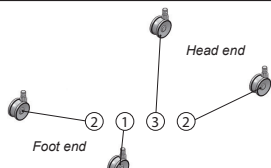
## Optional castors

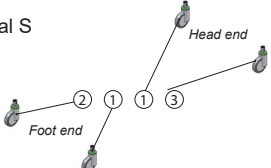
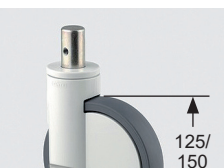
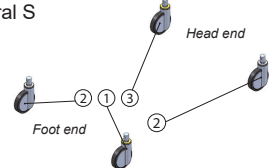
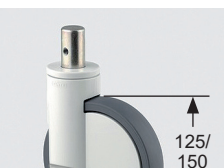
Item no.	Assembly	Components	Castor diameter	Height of bed surface increased to	
<b>BG6081</b>	Linea 	① 1 x R2095 - Directional device - Electrically conductive ② 2 x R2071 - Locking devices ③ 1 x R2070 - Locking device - Electrically conductive	125.0 mm	278.0 - 830.0 mm (Construction height: 130.0 mm)	
<b>BG6291</b>	Integral S 	① 2 x R2125 - Locking device ② 1 x R2126 - Locking device - Electrically conductive ③ 1 x R2127 - Directional device - Electrically conductive	125.0 mm	306.0 - 858.0 mm (Construction height: 158.0 mm)	
<b>BG5264</b>	Integral S 	① 1 x R2064 - Locking device - Electrically conductive ② 2 x R2065 Locking devices ③ 1 x R2107 - Directional device - Electrically conductive	150.0 mm	331.0 - 883.0 mm (Construction height: 183.0 mm)	

Item no.	Assembly	Components	Castor diameter	Construction height	Height of bed surface increased to
<b>R2071</b>	Linea	4 x R2071	125.0 mm	130.0 mm	284.0 - 834.0 mm
<b>R2125</b>	Integral S	4 x R2125	125.0 mm	158.0 mm	312.0 - 862.0 mm
<b>R2065</b>	Integral S	4 x R2065	150.0 mm	183.0 mm	337.0 - 887.0 mm
<b>R2115</b>	Steinco (manoeuvrable, standard model Select)	4 x R2115	100.0 mm	115.8 mm	---

These sets of castors each consist of four identical castors!

# Activation | General operating instructions

## Operating time

The maximum operating time of the electric motor-driven bed functions is specified on the bed or in the technical data.

2 min/18 min means that each electro-motive adjustment may be operated for a maximum of 2 minutes, after which a pause of 18 minutes is necessary (protection against overheating).

- ⚠ **NOTE** Should the maximum operating time of 2 minutes be exceeded repeatedly or for longer periods, protection devices on the bed may cause the electromechanical motor system to shut down. The bed must not be manoeuvred using the motors until it has cooled down sufficiently!

## Battery (optional)

The optional battery in the bed has a charging capacity that permits the theoretical continuous operation of at least two adjustment cycles.

- ⚠ **NOTE** If the bed is parked at its location and the power plug is not connected, this will cause the battery to discharge due to the buffering of the electronic components!

Exhaustively discharged batteries can become damaged to such an extent that premature replacement may be required!

Appropriate and correct use of the battery is essential for achieving a long battery life!

In order to guarantee electrical functionality at all times, the bed should be connected to the power plug as often as possible.

When storing the bed for a longer period, the battery must be recharged every 6 months if the storage temperature is approx. 25 °C.

At higher storage temperatures the time intervals are less frequent.

## Safety cut-out device

The bed is equipped with an electrical, self-resetting safety cut-out device that prevents the drives from overloading. In the event of very severe overloading, the bed is automatically switched off.

## Installation conditions

The bed is only approved for use in dry rooms (technical data sheet). A power supply is required for the operation of the bed in any suitable room.

Please note that the mains power socket for the bed must be freely accessible and must not be obstructed, e.g. by an item of furniture.

## Activation | Preparation 1/2

**Standard wiring of the control box (without using the under-bed light - standard for Select, and the distribution box)**

Each time before putting into operation or restarting, the correct order of the motor cabling at the control box must be checked:

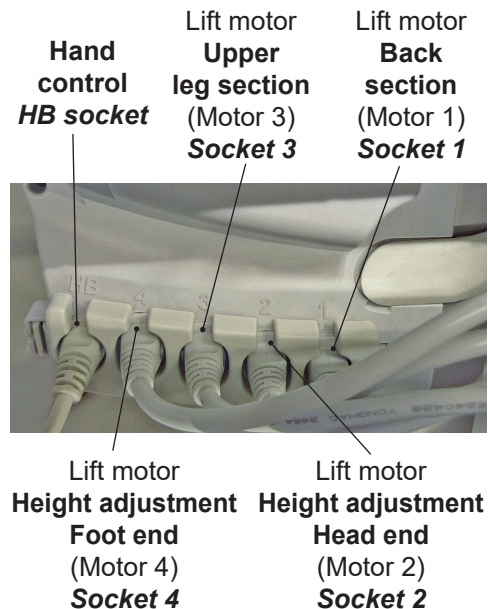

**Wiring with under-bed light and distribution box**

The distribution box must also be used when using the under-bed light. This is wired as shown below:



Under-bed light  
Free socket, e.g. for hand control  
Hand control

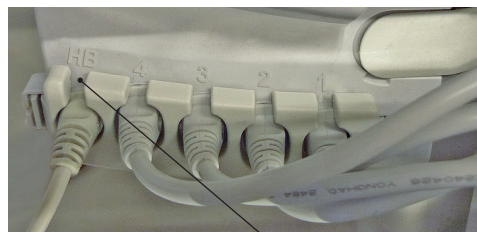

In this case, the HB socket of the control box is occupied by the under-bed light connecting cable.

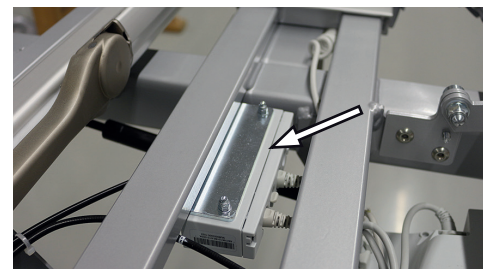

The distribution box is mounted under the fixed seat section.

When completely lowering the bed in the optional manoeuvrable version, it must be ensured that the hand control cable is not trapped between the lying surface and the roller carriage.

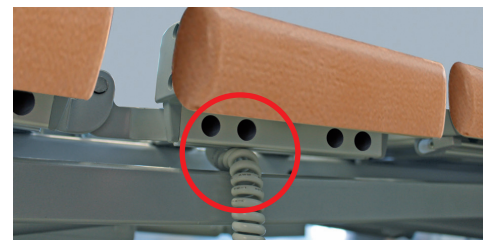

## Activation | Preparation 2/2

### Transporting the bed

The bed can be moved without auxiliary transportation equipment. For this, move the bed into the movement position (lying surface at a minimum height of 35 cm and release castor fixing).

The power cable must be secured for transporting the bed so that it cannot be rolled over or be damaged in any other way. The cable hook provided is to be used for this reason.



⚠ **NOTE** The standard version of the bed can only be controlled from the foot end.

⚠ **CAUTION** The bed is not designed for transporting people. If a patient is lying in the bed, it must only be pushed within the room. The bed should only be moved over a solid surface. Do not attempt to push the bed over obstacles of over 1 cm in height. The maximum angle of inclination of the floor must not exceed 6°.

⚠ **NOTE** The bed must be transported by at least two people, taking hold of the bed at the head and foot board.

⚠ **NOTE** Please be aware that incorrect handling can lead to the battery no longer charging. Incorrect handling includes actions such as pulling the cable of the power plug to remove it from the socket, clamping the power cable between the lying surface and lying surface frame as well as running over the cable when transporting the bed.

## Activation | Electrical activation

For activating the bed, it is only necessary to connect the power plug to the live power socket. The power cable must be set up so that it is not under tension.



Power cable with cable hook



Strain relief of the power cable at the head panel.

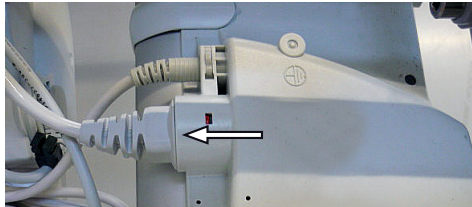

Connection of the power cable to the control box.



In order to avoid damage to the power cable by crushing, the cable must **not** be directed sideways across the head end, e.g. in order to reach a socket that is further away.

**⚠ WARNING** Check the power cable regularly for any damage. If the cable is damaged, the bed must not be used and must be taken out of service immediately!

After replacing the power cable (only by qualified personnel), the cable must be reattached with the cable harness. For this, the cable clips must be fixed to the points shown below.

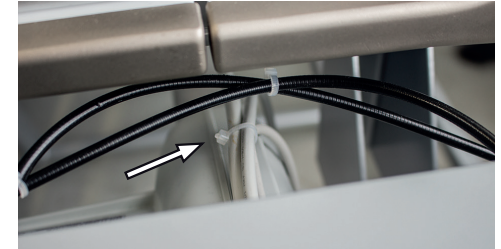

Position of the cable clip over the lying surface motor at the **head end**.



Position of the cable clip over the lying surface motor at the **foot end**.

## Activation | Use of the battery (optional) 1/2

A battery is optionally available for both bed models as an option.

The battery allows the bed to be operated independent of the power supply for at least two adjustment cycles under full load.

If the bed is connected to the power supply, the battery begins to charge automatically.

Upon initial start-up, the bed must be connected to the power supply for approximately 24 hours in order to fully charge the battery.

When storing the bed for a longer period, the battery must be charged regularly (every 3 months). The maximum charge time takes approx. 12 hours.

If an acoustic signal sounds, the battery must be recharged. The battery is deactivated just before total discharge. Once the bed is connected to the power supply, press any button on the hand control to render it fully functional again. The battery is charged when connected to the power supply after every use

or when there has been an excessive discharge.

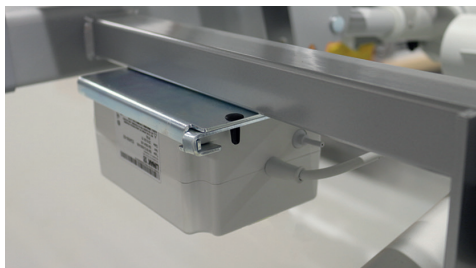

### Battery life

The battery must be replaced after four years at the latest, or earlier depending on the intensity of use. Frequent and rapid discharging will reduce the service life of the battery. To achieve optimum service life, the battery should be connected to the power supply as often as possible. The battery must be charged at least every three months to avoid damage due to self-discharge.

**NOTE** If the bed is stored for a longer period without being connected to the power supply, the battery can discharge. The degree of discharge depends on environmental conditions.

**NOTE** During the charging cycle, the battery is connected to the mains supply and is therefore supplied with electricity. The current cut-off is deactivated and current flows to the bed.

**WARNING** If electromagnetic interference occurs with other equipment in the area around the bed, please refrain from using these devices. When the bed is being transported, it must always be handled carefully and protected from moisture.



## Activation | Using the battery (optional) 2/2 and taking out of service

**NOTE** The bed is designed for use in an ambient temperature range from 5 °C to 40 °C, with a relative humidity of 30 % to 85 % and an air pressure of 700 to 1060 hPa.

**WARNING** The battery may only be replaced by personnel trained by Völker.

**WARNING** If the battery is faulty, degassing can occur. In rare cases, this can cause deformation of the battery housing. If this occurs, the bed must be taken out of service immediately and placed in a sufficiently ventilated room with no spark sources (away from electricity or fire). In this case, please contact Customer Service immediately!

### Taking out of service

The bed is taken out of service by disconnecting it from the power supply. The power plug is disconnected from the power socket for this.

Before carrying out repair work, or if the bed is put out of service for a longer time, the optional battery must be disconnected from the control box. To do this, the locking ring is raised and the plug pulled out of the connecting socket for this using a suitable tool (e.g. screwdriver).

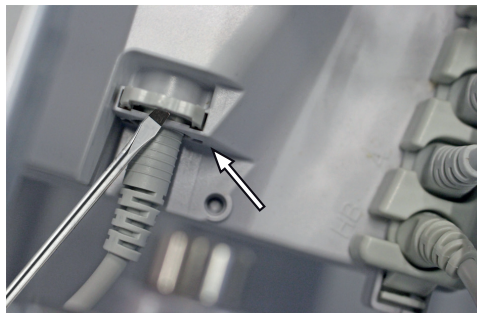

**WARNING** The battery must be disposed of in an environmentally friendly manner at the appropriate facilities. Alternatively, you can return it to Völker.

# Activation | Functional check

## Visual inspection

Before each new occupancy of the bed, the following checks must be carried out:

1. Ensure the bed exhibits no visible signs of damage.
2. Ensure that the insulation of the electrical lines is in order.
3. Ensure that the motor cables are plugged into corresponding sockets of the control box according to the numbering.
4. Ensure that the next testing date has not been missed.
5. The power cable must be checked regularly for damage.

## Functional test

A functional test must be carried out before each new occupancy:

1. All electrical functions must be actuated to their terminal positions once.
2. The function of all side rails must be checked.
3. The secure position of the bed must be checked.

Once a fault-free functional check has been carried out, the bed is ready for use.

 **WARNING** Only undamaged beds that are still within their testing interval periods may be used!

## Operation | Guide castors 1/2 - Roller carriage 4+2

The bed has two castors at the head end and four guide castors at the foot end, two of which can be braked. To move the bed, the castor fixing must be released by operating the foot pedals. When moving the bed, the lying surface must be at a height of at least 35 cm.



### **CAUTION "Risk of accident"**

If the bed is not moved, the guide castors must always be fixed and latched into place since the bed may be required as a support for when the occupant/patient stands up or lies down. If the bed rolls away without the castors being braked, this can lead to a serious fall.



**NOTE** The bed is not suitable for transporting the occupant/patient.

Once the castors have been applied, check that the bed is actually properly parked.

### **A. Apply guide castors**

To apply the castors, tread on the foot pedals of the guide castors at the foot end until they latch into place.



Foot pedal in **braked** position.

### **B. Release guide castors**

Press the foot pedal of the guide castors upwards with your foot to release the fixed guide castors.

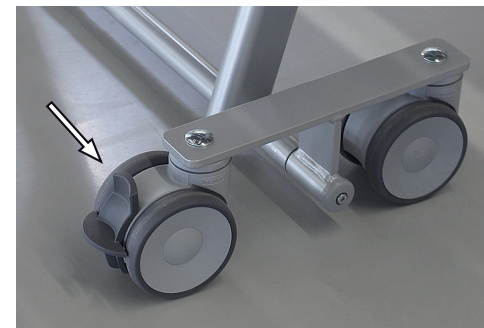

Foot pedal in **unbraked** position.

# Operation | Guide castors 2/2 - manoeuvrable version, runner carriage 2+2 (optional)

## A. Applying the brakes

Move the foot pedal downwards on each side to secure the bed. This brakes both castors on the relevant side at the head and foot end.



Foot pedal of the optional manoeuvrable version in **braked** position.

## B. Releasing the brakes

Move the foot pedal upwards on each side with your foot in order to release the brakes of both castors on the corresponding side.



Foot pedal of the optional manoeuvrable version in **unbraked** position.

## C. Automatic brake function

The manoeuvrable version of the bed has an automatic brake function if the lying surface is moved to the lowest position using the hand control. In this case, both foot pedals of the bed frame are pressed downwards. To release the brakes, the lying surface must be raised and the brakes released as shown opposite.

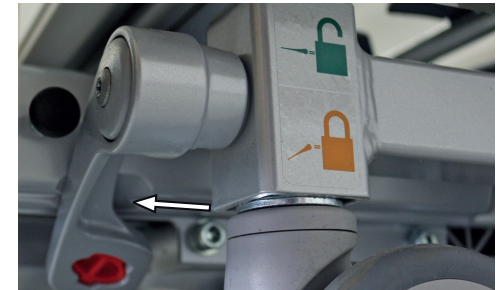

Automatic brake function

**⚠ WARNING** In order to extensively prevent the bed from accidentally moving out of place, all castors must be kept clean and dry.

## Operation | Side rails | General safety notes



**WARNING** All people whose duties involve manoeuvring of the side rails must have read and understood the following information:

- During actuation of the back, upper leg or lower leg section adjustment, of the lift or of the side rails, it must always be ensured that the occupant-/patient is not touching the siderails, and that no part of his/her body is sticking out through the side rails.
- If the side rails are used for an individual whose psychological condition necessitates their use, it must be ensured that the hand control is kept completely out of his/her reach or its functions are completely locked. In all cases, care must be taken to ensure that risks are minimised.
- Protective covers (cot side pads) are available as an accessory for the side rails. These provide additional protection against injury from

contact with the side rails. The use of these protective covers is recommended for all persons for whom the risk of injury from unavoidable contact with the side rails is very high. Even with the covers, the care personnel or occupant/patient must still take the necessary care when operating the bed.

- All types of side rails must always be either completely raised and securely engaged, or completely lowered to the end stop. Because of the risk of entrapment, they must **never** be left in a position where they are not completely engaged.
- If the side rails are damaged, there is a risk that the patient will fall out of bed.
- The side rails must only be operated by trained care staff.

- Ensure that no body parts are protruding through the side rails when the electrical lying surface adjustment function is activated.
- Ensure that the side rails (or parts thereof) are either fully raised and locked or fully lowered.



**DANGER** Failure on the part of care staff to observe the above safety measures may result in injury.

All types of Völker side rails can only be replaced with tools. Only side rails approved by Völker GmbH may be used for the bed.

## Operation | Continuous side rails - Style model

### A. Raising the side rails

To raise the side rails, take hold of the grip recess and lift them first at the head end and then at the foot end until the rail audibly engages.



### B. Lowering the side rails

Starting at the foot end, take hold of the recess grip and lift the top rail slightly. Press the button on the side and lower the side rail first at the foot end by hand. Repeat at the head end.



For safety reasons, the continuous side rails cannot be released when pressure is exerted on them from above.

#### All side rails down:

The bed is accessible without restriction from both sides.

#### All side rails up:

The occupant/patient enjoys maximum protection from rolling out of bed.

To prevent the patient from falling out of bed, the continuous side rails must always be raised at the head end first and always lowered again first at the foot end!

 **WARNING** If other devices are operated on the bed, which are provided with cables, air hoses or similar, make sure that these lines are routed so that they cannot become jammed in the moving parts of the bed or be damaged.

# Operation | Divided side rails - Select model 1/2

## A. Setting up the side rails



1. Pull the side rail out horizontally until the end stop, and raise it upwards.

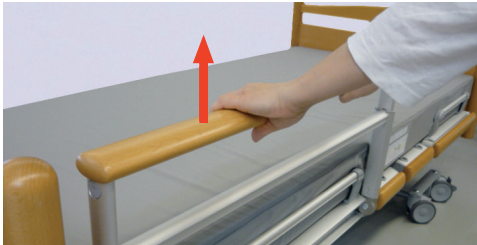

2. To adjust the height of the side rail, pull the telescopic section upwards until it reaches its end stop.

## B. Lowering the side rails

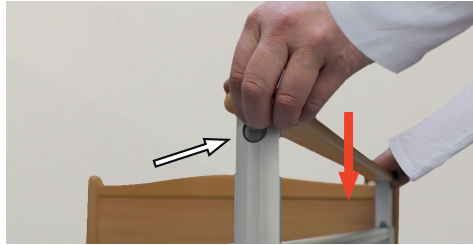

1. Press both buttons on the outside of the frame to bring the height-adjustable side rail to its lowest position.



2. Press the "Drücken / Press" trigger at the lower edge of the side rail and tilt it sideways into a horizontal position, so that it lies parallel to the floor.



3. Push the side rail completely underneath the lying surface.

The side rails can be used individually or together as required to protect the occupant/patient. Raising all four side rails offers the occupant/patient maximum protection.

## Operation | Divided side rails - Select model 2/2



⚠ **NOTE** The side rails should always be gripped with two hands at the ends of the element in question and guided upwards or downwards.

⚠ **CAUTION** Any weight on side rail elements that are pulled out horizontally must not exceed 15 kg!

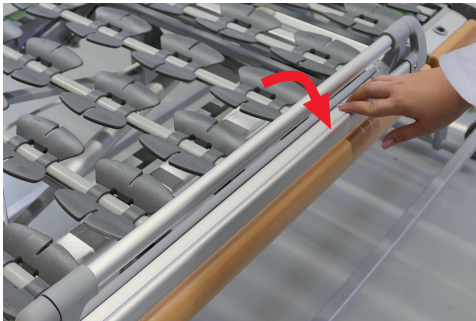

⚠ **NOTE** Due to their exceptional stability, the side rail elements can also be used as a surface for storing bed linen (max. 15 kg) or as an additional supporting surface for care-related positions, such as Bobath treatments, or for the delivery of physiotherapy-related treatments.

When using the raised side rails 43.5 - 45 cm, the mattress holder must be folded in or out.



## Operation | Hand control | Hand control lock | Keeping safe

Activating the hand control lock disables all of the functions of the hand control.

If the bed functions cannot be actuated, check whether the hand control lock is activated.

The lock switch is located on the front of the hand control.

It is unlocked (lock open) or locked (locked closed) using a key.

The lock switch must only be operated by the care personnel.



Lock switch socket key

Lock switch

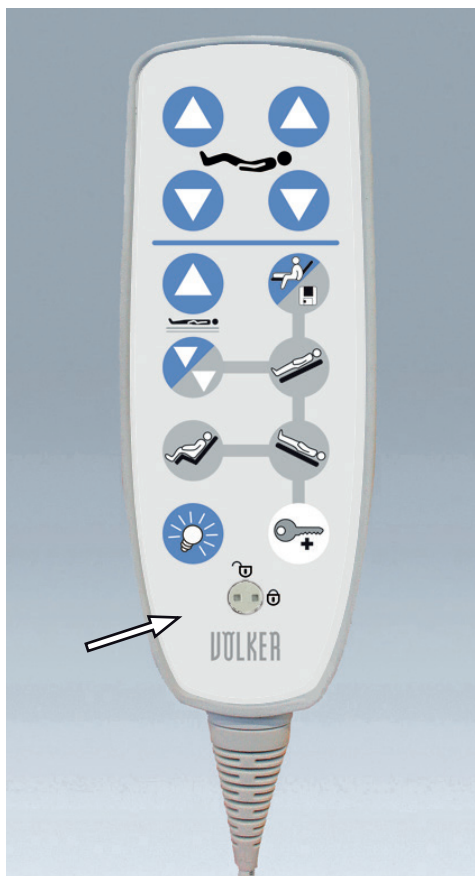

The hand controls have a hook on the rear and can be hung on the side rails, for example.

## Operation | Hand control | Adjusting the upper leg section

The upper leg section can be adjusted using the hand control.

If necessary, disable the hand control lock via the lock switch.

The upper leg section can be raised up to an angle of 45°.

**⚠ WARNING** When the upper or lower leg section is being raised with the side rails up, it must be ensured that none of the occupant's/patient's or any other person's body parts are sticking out through the assembled side rails or are on top of them!

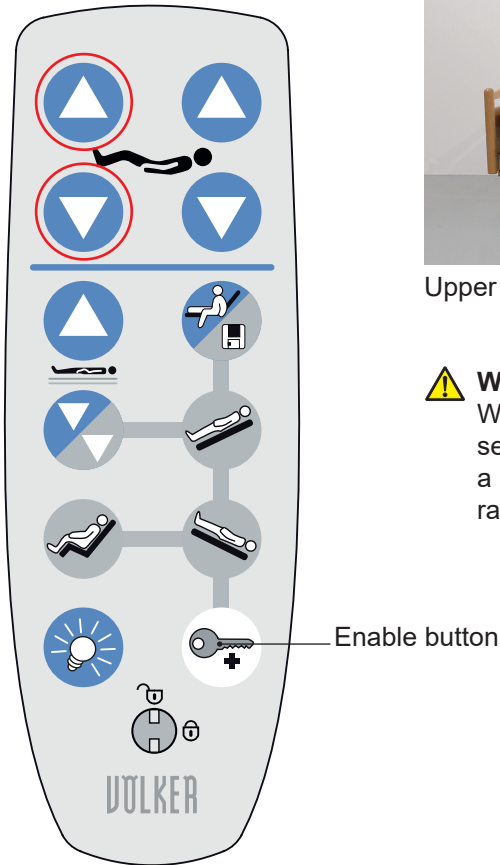

Upper leg section up

**⚠ WARNING "Risk of entrapment"** When the position of the upper leg section is being adjusted, there is a risk of entrapment between the raised side rail and the foot board.

## Operation | Hand control | Adjusting the lower leg section (manually)

The lower leg section can be moved manually to any position of maximum 45° by pulling on the mattress holder. The Style model features a handle that allows the lower leg section to be moved up and down.

To lower the lower leg section, the mattress holder or handle is pulled and the section lifted to the end stop and then lowered. The locking mechanism is disengaged automatically.



Lower leg section up

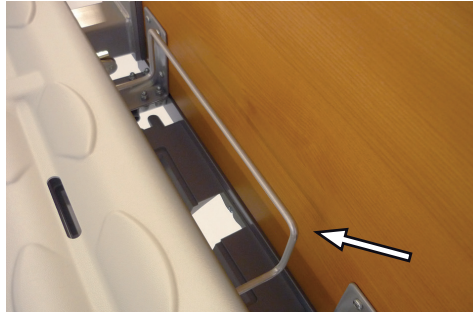

Handle on the lower leg section of the Style model.



Mechanism for adjusting the height of the upper leg section.

**⚠ WARNING** When the upper or lower leg section is being raised with the side rails up, it must be ensured that none of the occupant's/patient's or any other person's body parts are sticking out through the assembled side rails or are on top of them!

## Operation | Hand control | Adjusting the back section

The back section can be adjusted with the hand control.

If necessary, disable the hand control lock via the lock switch.

The back section of the lying surface can be raised up to an angle of 70°.

The back section and upper leg section can be adjusted simultaneously by pressing both switches at the same time:

- Back section up + Upper leg section up  
or
- Back section down + Upper leg section down

If one of the two buttons is released during this adjustment process, the movement of the other lying surface is continued.

Operation of the switches "crosswise" is not possible (e.g. back section up + upper leg section down).

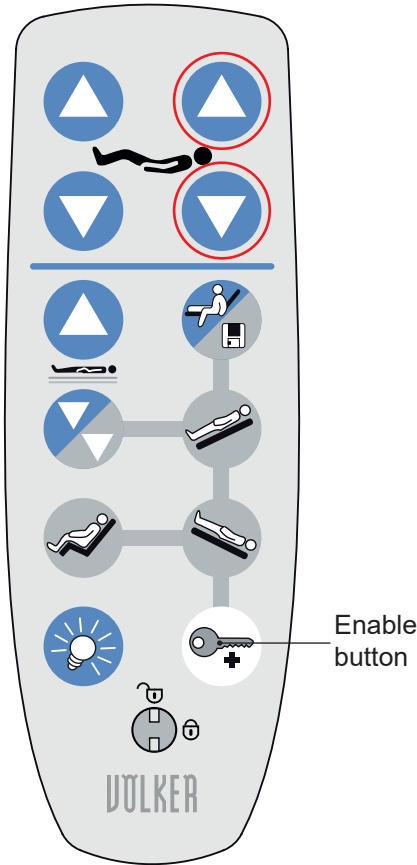

Back section up

**⚠ WARNING** When the back section is being raised with the side rails up, it must be ensured that none of the occupant's/patient's or any other person's body parts are sticking out through the side rails or are on top of them!

## Operation | Hand control | Adjusting the lying surface height

The lying surface height can be adjusted using the hand control.

If necessary, disable the hand control lock via the lock switch.

The lying surface height for both models with MiS® lying surfaces can be adjusted between approx. 20 cm and approx. 80 cm.

The lying surface can only be moved down by the occupant/patient to a height of approx. 35 cm.

The button sequence below must be followed to move the lying surface below 35 cm:

- Press the enable button briefly and release again
- After this (within one second), press the "Lying surface" button until the desired position is reached.

The operation of the enable button is only reserved for care personnel.

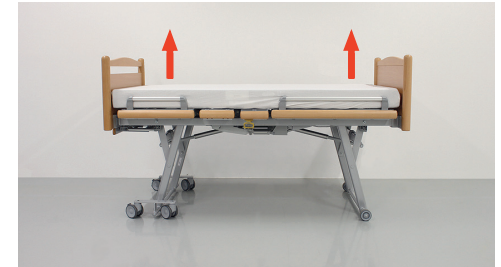
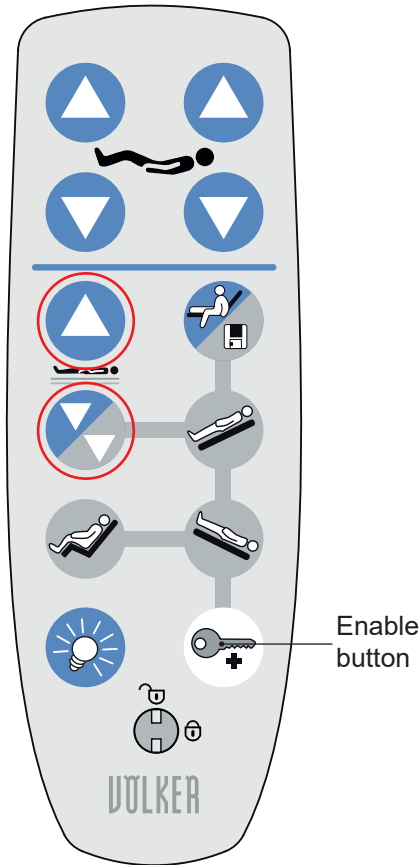

Lying surface up

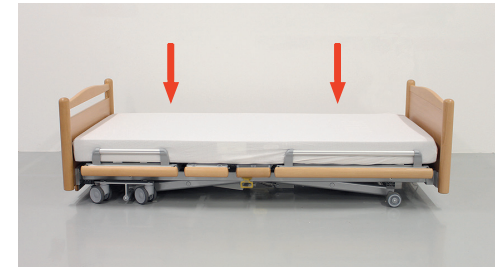

Lying surface down

Enable button



**DANGER** Before lowering or raising the lying surface, it must be ensured that no people, limbs, pets, bed linen or other objects are trapped between the lying surface and the lower frame or floor.

## Operation | Hand control | Setting the aid for getting out of bed

The "Aid for getting out of bed" button can be used to move the bed into a position with the press of a button, which enables the occupant/patient to leave the bed from the side.

If necessary, disable the hand control lock via the lock switch.

If no height position is saved, the lying surface moves to a height of approx. 35 cm.

It is advisable to save a height position which enables the occupant/patient to leave the bed safely and comfortably from the side.

When getting onto and off the bed, it must be ensured that it is stable (fix guide castors)!

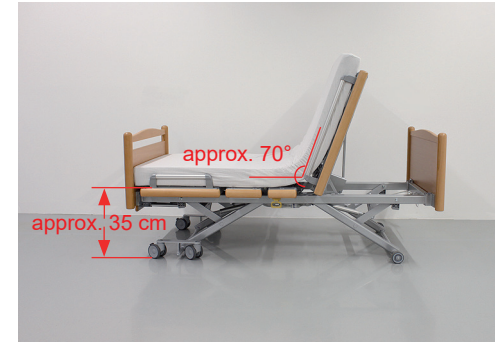
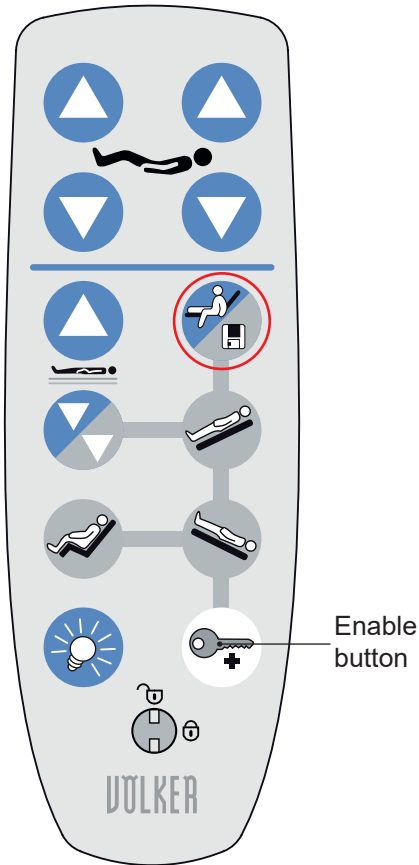

Aid for getting out of bed

An individual height of the getting out of bed position can be stored between 38 cm and 58 cm height for MiS® lying surfaces. With HPL lying surfaces, this is possible between 36,5 cm and 56,5 cm.

## Operation | Hand control | Saving the lying surface height position

This function is primarily designed to save a height position which enables the occupant/patient to leave the bed safely and comfortably from the side.

If necessary, disable the hand control lock via the lock switch.

The following button sequence is necessary to save the lying surface position.

- Press the enable button briefly and release again
- After this (within two seconds), press the "Aid for getting out of bed/Save function" button until a signal confirms it has been saved.

The operation of the enable button is only reserved for care personnel.

If the lying surface is moved, it will stop briefly in the saved position (approx. 0.5 seconds) and then continue moving as long as the "Lying surface height adjustment" button is pressed.

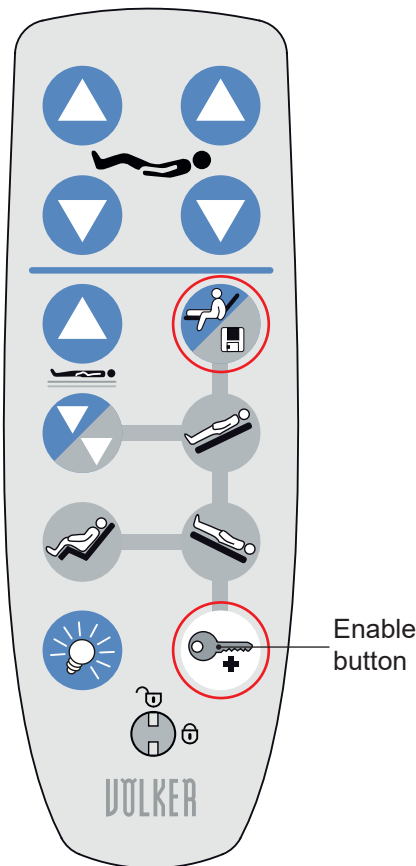

The position saving is retained until a new saving is made.

Height memorisation range  
35 to 55 cm\* or  
40 to 60 cm\*

\* dependent on configuration chosen

## Operation | Hand control | Setting the Anti-Trendelenburg position<sup>1</sup>

The Anti-Trendelenburg position can be adjusted up to an angle of 14°.

If necessary, disable the hand control lock via the lock switch.

The button sequence below must be followed to set the Anti-Trendelenburg position:

- Press the enable button briefly and release again
- After this (within one second), press the "Anti-Trendelenburg position" button until the desired position is reached.

The operation of the enable button is only reserved for care personnel.

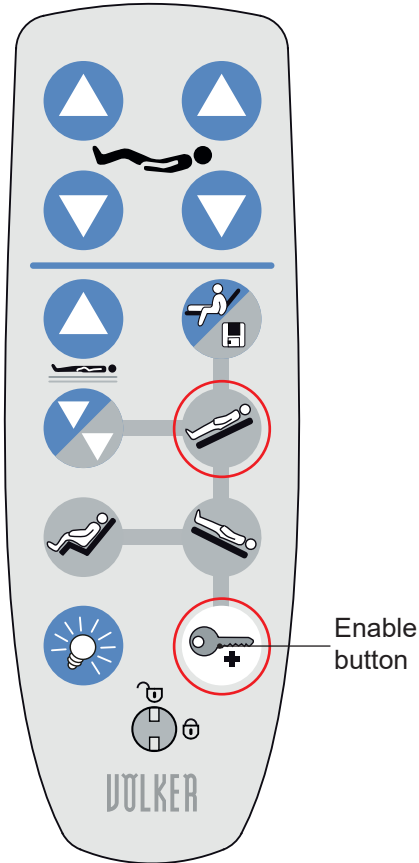

Anti-Trendelenburg position

<sup>1</sup> Head end raised



## Operation | Hand control | Setting the Trendelenburg position<sup>1</sup>

**⚠ WARNING** Since the Trendelenburg positioning depends on clinical indications, it must only be used with appropriate clinical approval.

The Trendelenburg position can be adjusted up to an angle of 14°.

If necessary, disable the hand control lock via the lock switch.

The following button sequence must be followed to set the Trendelenburg position:

- Press the enable button briefly and release again
- After this (within one second), press the "Trendelenburg position" button until the desired position is reached.

The operation of the enable button is only reserved for care personnel.

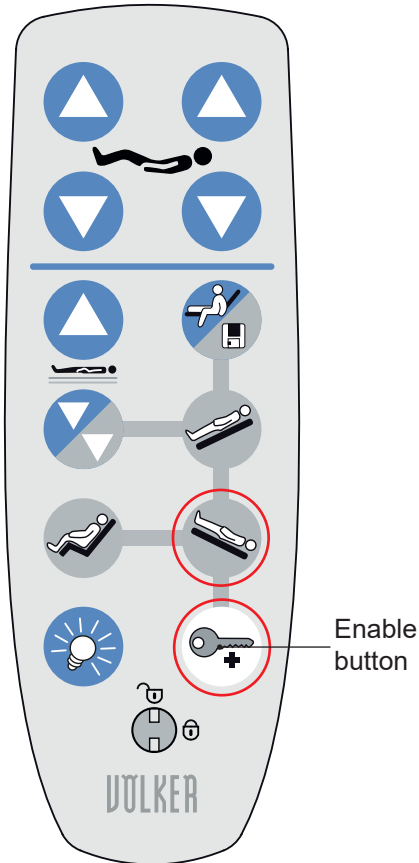

Trendelenburg position

<sup>1</sup> Head end lowered

## Operation | Hand control | Setting the position "Easy chair"

Occupants/patients who are unable to leave the bed have a major advantage through the sitting position. This ensures an active sitting posture in the bed.

If necessary, disable the hand control lock via the lock switch.

The following button sequence must be followed to set the sitting position:

- Press the enable button briefly and release again
- After this (within one second), press the "Easy chair" button until the desired position is reached.

The operation of the enable button is only reserved for care personnel.

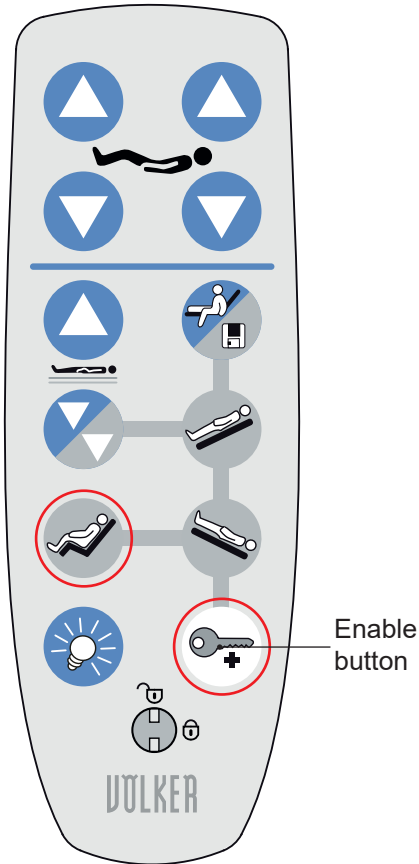

Easy chair

## Operation | Hand control | Setting the position "Flat and horizontal"

The "Flat and horizontal" position is reached by simultaneously pressing the buttons "Upper leg section down" and "Back section down".

If necessary, disable the hand control lock via the lock switch.

If both buttons are pressed at the same time, the back section and upper leg section move into the lowest position. After this, the lying surface is moved into the horizontal position.

If one of the two buttons is released during the adjustment process, the movement still pressed is continued.

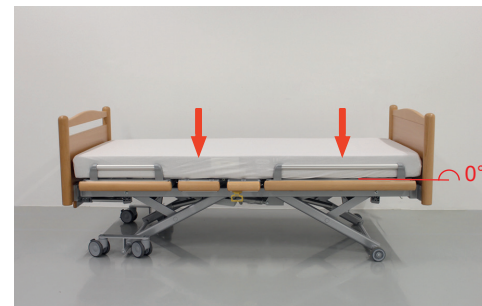
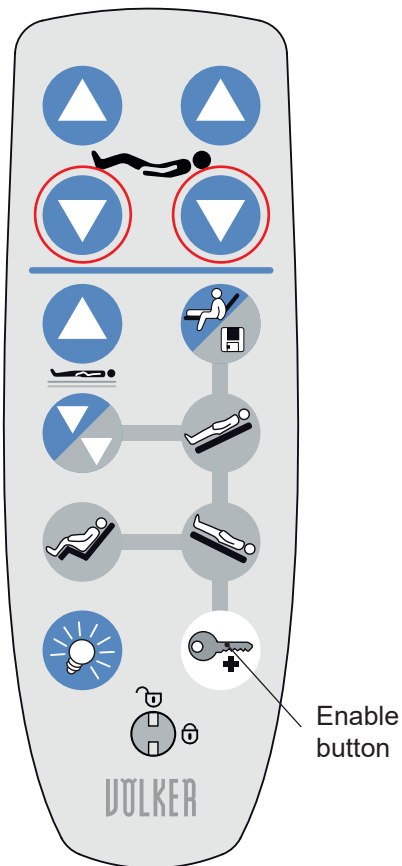

In the event that the bed completely ceases to function, the hand control can be restored to factory settings with this button combination.

To do this, the buttons "Upper leg section down" and "Back section down" must be pressed simultaneously for approximately ten seconds until an acoustic signal confirms the reset.

## Operation | Hand control | Under-bed light

The "Under-bed light" button can be used to switch the lighting below the bed on and off.

If necessary, disable the hand control lock via the lock switch.



The under-bed light is mounted in the center below the lying surface.

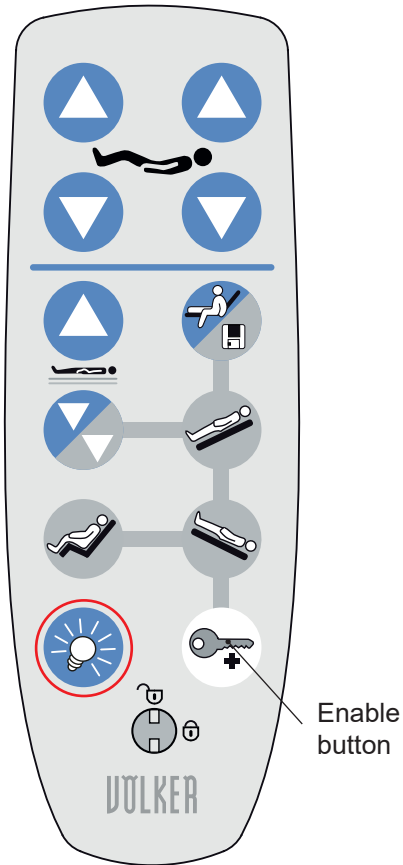

## Operation | Hand control | Functions of the enable button

### The operation of the enable button is only reserved for care personnel!

The enable button serves to enable the positions or functions:

- Height position saving
- Lying surface height below 35 cm
- Anti-Trendelenburg position
- Trendelenburg position
- Sitting position

If necessary, disable the hand control lock via the lock switch.

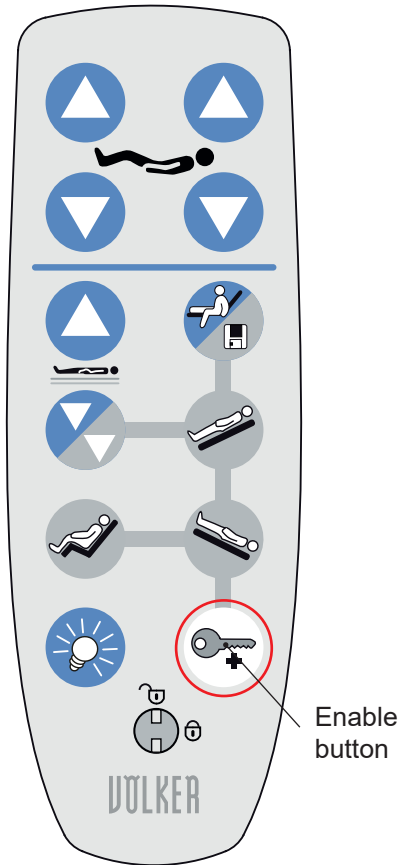

The following button sequence must be followed to enable the positions required by the enable button:

- Press the enable button briefly and release again
- After this (within **one** second), press the corresponding (grey) function button until the relevant position is reached.

The following button sequence is necessary to save the **lying surface position**:

- Press the enable button briefly and release again
- After this (within **two** seconds), press the "Save function" button until an acoustic signal confirms the saving.

## Operation | Rapid lowering of the back section / CPR function

Both models of the bed have a mechanical rapid lowering of the back section for reanimation as standard.



Lever for rapid lowering of the back section for reanimation, both sides below the seat area.

Pull the lever forwards for rapid lowering of the back section. The back section now moves quickly downwards.



The motor of the backrest is automatically reactivated if the CPR handle is released.

**⚠ WARNING** The CPR function (Cardiopulmonary Resuscitation function) may only be executed in an **emergency** and only by trained specialist personnel!

**⚠ WARNING** The CPR function may **not** be used instead of the hand control for lowering the back section!

**⚠ WARNING** It is essential to hold the back section firmly by the mattress holder to avoid sudden lowering with the patient!

Improper use of the CPR function can cause damage to the bed and/or the motor of the back section!

## Operation | Dynamic bed extension (optional Select model)

The Select model can be equipped with a telescopic bed extension.  
Extension: approx. 28 cm.

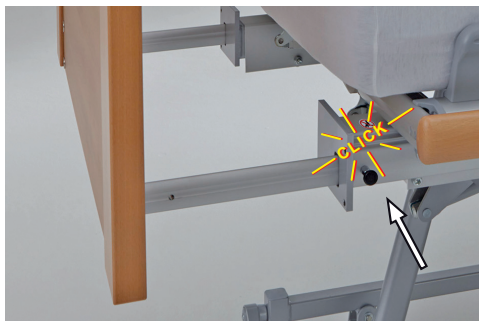

To unlock the bed extension, pull the two pins located on the side outwards and turn the knobs by about 45°. The bed extension can now be pulled out. To lock, the knobs must be turned back again until the pins latch in automatically and **audibly**.

The pulled-in bed extension must also be latched into place!

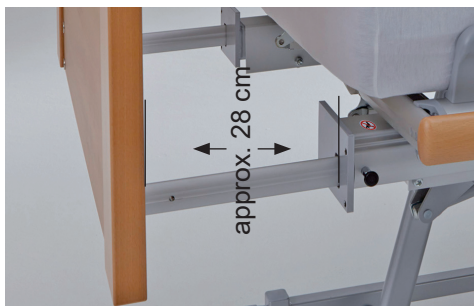

Bed extension moved out

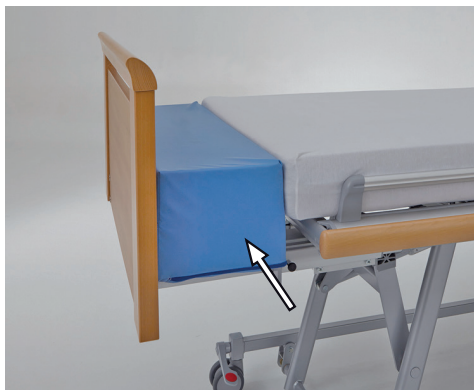

An additional mattress extension (PMA2215) must be used when using the dynamic bed extension.

⚠ **NOTE** When using a dynamic bed extension, only mattresses with a height of 12 cm may be used.

⚠ **WARNING** The bed extension may not be used as a seat!  
The safe working load is 50 kg.

# Cleaning and disinfection 1/2

To maintain the bed's functionality, it must be cleaned, disinfected and tested

- At regular intervals
- As required
- After every change of occupant
- In accordance with the guidelines of the relevant hygiene schedule

so that it can be used again immediately and without risk. The level of disinfection required must be determined by the user!

Hazards may arise due to improper cleaning/disinfection of the bed.

The degree of disinfection must be determined by the user!

As a general rule, only use disinfectants that are in line with current technological standards.

The current healthcare standard can be found, for example, in the VAH List [from the German Association of Applied Hygiene], RKI [Robert Koch Institute] guidelines or also in the IHO List [from the German Industrial Association for Hygiene and Surface Protection].

Unless any specific ingredients that must NOT be used are given in the respective instructions for use, the disinfectants listed there may be used.

All disinfectants must be used according to the disinfectant manufacturer's instructions.

Due to the large number of available products, Völker GmbH cannot approve specific products and list them in the instructions for use.

Please observe the information provided by the cleaning product manufacturer.

Not following these instructions can lead to personal injury and material damage.



**WARNING** The bed must always be disconnected from the power supply before being cleaned and disinfected.

## Cleaning

Depending on the degree of soiling, we recommend cleaning the bed with a damp cloth or similar. A soft brush can also be used for stubborn dirt or stains.

Do not moisten the bed too much when cleaning.

## Disinfection by wiping

Use cleaning agents in the dilution ratio recommended in the relevant instructions for use issued by the cleaning product manufacturers.

 **NOTE** Use of solvents is not permitted.

- Abrasives, scouring pads or other scouring agents must **not** be used.
- Use of chlorine, formaldehyde, phenol-based products and other solvents (toluene, xylene or acetone) is **not** permitted.

The following information regarding cleaning products and disinfectants must be observed:

- The solutions being used must generally be freshly prepared.
- The concentrations used should be neither higher nor lower than specified. Approximate concentrations must not be used



## Cleaning and disinfection 2/2

under any circumstances. Under no circumstances must users add cleaning products such as soap or surfactants at their own discretion (inactivation by contact with soap).

- There is a risk of explosion and fire when spray disinfectants containing alcohol are used over large areas.
- Cleaning products must not contain corrosive or caustic ingredients.
- They must not contain any substances that will change the surface structure or the gripping properties of materials.
- Lubricants must not be affected.
- The pH of the water must be no higher or lower than 5–8.
- Water must not exceed a total water hardness of 0.5 mmol/l (corresponding to 5°dH).

The information provided by us does not exempt users from conducting their own investigations and tests as local conditions (e.g. water hardness) can vary. No legally binding assurance of certain properties can be deduced from

this information.

Cable plugs and the sockets of the control unit, distributor box and battery are only protected against splashes when connected and when protected by the covers and blind plugs provided.

- Prevent the ingress of water and cleaning agents into unused connections.
- Labels and markings must not be cleaned with a brush or using high pressure.
- Dry the bed with special care and test it before reuse.
- Stubborn dirt or stains must be soaked before cleaning (please test first).

### Spray lances and washing systems\*



**WARNING** Cleaning and disinfection with spray lances of high-pressure cleaning equipment is **not** permitted.

Völker GmbH accepts no liability for damage sustained to the surface

coating through the use of unsuitable detergents and disinfectants, incorrect mixing ratios or insufficient care of the beds.

### Cleaning the hand control units/ keypads

The hand control units and keypads must be cleaned daily to avoid cross-contamination between the patient and care staff.

---

\*Please refer to the information on the type plate to ascertain whether your bed is suitable for a washing system.

# Maintenance | Staff training, safety notes

## Personnel qualifications

Anyone responsible for carrying out maintenance and servicing must at least have read the safety notes for the respective bed model and be qualified in accordance with the national regulations.

To ensure that the beds work properly, the user instructions must always be accessible to the service personnel.

## Safety instructions

The following requirements must be strictly observed during maintenance and technical checks:

- The room's electrical installations must satisfy the current technical requirements and the bed must be used correctly.
- The beds are not protected against explosion and must therefore only be maintained in an environment free from flammable substances and materials.

 **WARNING** Always pull out the power plug before carrying out repair work.

 **WARNING** Maintenance and repair work may only be carried out after disinfection of the bed.

## Maintenance | Maintenance schedule

The bed requires little maintenance. All movable parts for the height adjustment mechanism, the lying surface motor systems and the side rails are provided with long-lasting lubricant at the factory. It is recommended that **the bed is subjected to regular, or at least once a year, technical checks (including visual inspection and functional check) as described in the checklist** and any damage uncovered as a result, such as signs of wear and tear, loose screws or breaks/fractures, be eliminated immediately.

After every lengthy period of non-use, technical checks must be carried out.

Interval	Works to be performed
Annually	Technical checks (p.60 f.)
After lengthy periods of non-use	Visual inspection and functional check (p.34)
If necessary	Lubrication of mechanical parts Replacement of the optional battery if defective or upon reaching the end of its service life (3 years) Replacement of wearing parts if defective <ul style="list-style-type: none"><li>• Wings of the MiS® lying surface (if fitted)</li><li>• Spring elements of the MiS® lying surface (if fitted)</li></ul>

# Technical checks 1/2

## 1. Visual inspection

Check the frame parts for plastic deformations and/or wear and tear. These include the lower frame, the lifting mechanism, all parts of the lying surface (back, seat, upper leg and lower leg sections, wings and spring elements, if fitted), trapeze bar, trapeze bar holder and castors.

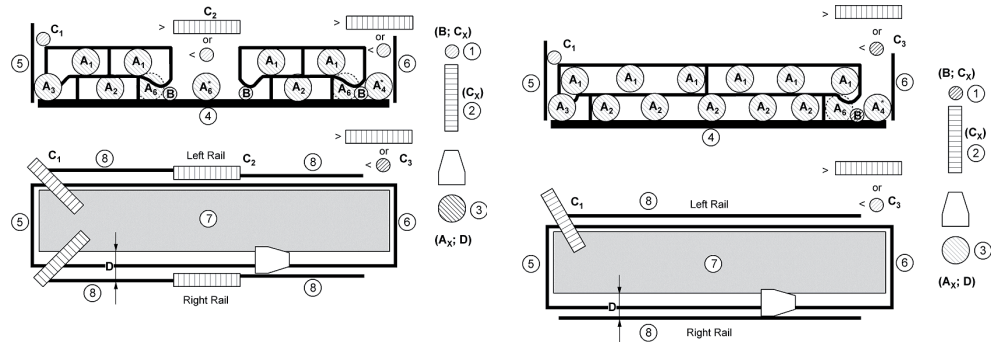

## 2. Functional check of the side rails

The side rails must be checked in accordance with DIN EN 60601-2-52.

### Inspection in accordance with DIN EN 60601-2-52

Check that the locking mechanism for the side rails is working correctly and that there are no visible deformations or signs of wear on the side rails.

Check that the prescribed distances are maintained, even when the side rails are placed under load.

Letter	Description	Dimension
A <sub>x</sub>	The distance between elements within the scope of the SIDE RAIL in its raised/engaged position or of the area formed by the SIDE RAILS and the fixed parts of the BED or ACCESSORIES.	< 120 mm
B	Not applicable	-
C <sub>1</sub>	Distance between HEAD BOARD and SIDE RAIL	< 60 mm
C <sub>2,3</sub>	Distance between divided SIDE RAILS and distance between SIDE RAIL and FOOT BOARD	< 60 mm or > 318 mm
D	Area between SIDE RAIL and MATTRESS	120 mm cone may sink max. 60 mm under the mattress surface without pressure
G	Height of the upper edges of the SIDE RAILS above the mattress without compression over at least 1/2 of the length of the LYING SURFACE	≥ 220 mm

## Technical checks 2/2

### 3. Functional check of the brakes

Check the function of the brakes.

### 4. Functional check of the motors

Travel through the full adjustment range of each motor. Look out for any unusual noises, watching the speed, ease of running etc., and check that the selected function travels in the correct direction. In particular, ensure that the motor switches off automatically when it reaches its terminal position\*.

### 5. Power connection cable

Check:

- the power connection cable, including cable guides,
- the strain relief, including the kink protection sleeve,
- the power connection plug for damage.

### 6. Cabling

Check the cable guides and that the plug connectors are correctly seated and do not exhibit any damage.

Check the cables for damage.

### 7. Housing

Check all housings for damage. All screws must be firmly tightened and seals must not exhibit any visible damage.

### 8. Mechanical check

Check the function of the Rastomats by manually moving the lower leg section to the individual positions.

### 9. Trapeze bar grab handle

Check whether the plastic and holding frame of the trapeze bar grab handle aid exhibit any damage and that the fixing rods on the trapeze bar are intact. The handle of the trapeze bar and fastening strap must be replaced in the following cycle:

- every 5 years: Trapeze bar grab handle and trapeze bar grab handle with roll function in elderly care service

### 10. Further accessories

Further accessories must always be checked in accordance with the manufacturer's instructions.

\* Please note that the terminal position can vary from bed model to bed model. Please consult the technical specifications for this or, if in doubt, contact our service department.

## Troubleshooting | Table of faults 1/3

The table below contains information on possible problems that users can resolve themselves.

Anyone responsible for carrying out maintenance and servicing must at least have read the safety notes for the respective bed model and be qualified in accordance with the national regulations.

To ensure that the beds work properly, the user instructions must always be accessible to the service personnel.

 **NOTE** Before carrying out any troubleshooting, check that the bed is connected to the power supply (the power plug is in a live socket).

 **WARNING** Make sure that the bed is disconnected from the power supply again before beginning repair work.

## Troubleshooting | Table of faults 2/3

Fault	Possible cause	Troubleshooting
Adjustment of the lying surface not functioning	<ul style="list-style-type: none"> <li>(1) Hand control locked</li> <li>(2) The power plug is not plugged in or there is no power to the socket</li> <li>(3) Battery not functioning</li> <li>(4) Hand control not functioning</li> </ul>	<ul style="list-style-type: none"> <li>(1) Unlock hand control</li> <li>(2) Connect the plug or check the socket</li> <li>(3) Check/Replace battery Check/Replace power cable</li> <li>(4) Unlock hand control or insert plug or replace hand control</li> </ul>
The bed cannot be adjusted in height	<ul style="list-style-type: none"> <li>(1) Hand control not functioning</li> <li>(2) The power plug is not plugged in or there is no power to the socket</li> <li>(3) Battery not functioning</li> <li>(4) Hand control locked</li> </ul>	<ul style="list-style-type: none"> <li>(1) Unlock hand control or insert plug or replace hand control</li> <li>(2) Connect the plug or check the socket</li> <li>(3) Check/Replace battery Check/Replace power cable</li> <li>(4) Unlock hand control</li> </ul>

*Continued on next page* ⇒













## Troubleshooting | Table of faults 3/3

Fault	Possible cause	Troubleshooting
Adjustment of the back section not functioning	(1) CPR lever jammed	(1) Check whether the CPR lever is jammed and correct/replace if necessary
Adjustment of the mechanically adjustable lower leg section not functioning	(1) Rastomat defective	(1) Replace Rastomat
Bed not functioning  Under-bed light (optional) not functioning  Bed not functioning after 2 minutes adjustment	(2) Bed is locked electronically  (3) Hand control not connected to the bed or lamp defective  (4) Adjustment cycle of 2 minutes exceeded	(2) Unlock hand control  (3) Connect hand control to the bed or replace lamp  (4) Wait for cooling cycle (18 minutes)









# Appendix | Symbols used 1/2

## Symbols on the type plates





	Manufacturer
	Model name
	Serial number
	Medical Device
	Maximum permitted patient weight
	Safe working load
	The product meets the essential requirements of Annex 1 of EU-Regulation 2017/745.
	Type B applied part in accordance with DIN EN 60601-1
	Protection class II equipment, double-insulated
	Note the information in the instructions for use
	The device must be disposed of in accordance with EU Directive 2002/96/EC on waste electrical and electronic equipment
	Certified by TÜV SÜD (South German technical inspection association)

## Warning signs and notes in the text

	<b>Warning sign</b> Information marked with this symbol must be read and strictly observed
	<b>NOTE</b> warns of possible material damage
	Warns of sources of electrical interference
	Protection class II or device with internal electrical power source
	Type B device
	Information arrow
	Direction arrows

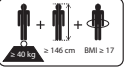
# Appendix | Symbols used 2/2

## Labels

	Mass of the mobile medical device including safe working load
	Description of an adult: Weight: min. 40 kg Height: min. 146 cm BMI: min. 17
	Please read and observe the notes and instructions for use of the mattresses
	Warns of crushing and trapping hazard
	Do not sit here!



### Braked bed

(Beds with roller carriage 2+4)



### Unbraked bed

### Braked bed

(Beds with runner carriage 2+2)

## Appendix | Technical data (standard design) 1/2

Dimensions	Style	Select
Height from floor to frame upper edge	approx. 740 mm	approx. 740 mm
Bed height	<p>MiS® lying surface with roller carriage (4+2): 25 cm - 80 cm</p> <p>Plastic lying surface with roller carriage (4+2): 20 cm - 75 cm</p> <p>MiS® lying surface with roller carriage (2+2): 27 cm - 82 cm</p> <p>Plastic lying surface with roller carriage (2+2): 22 cm - 77 cm</p>	<p>MiS® lying surface with roller carriage (4+2): 25 cm - 80 cm</p> <p>HPL lying surface with roller carriage (4+2): 22 cm - 78 cm</p> <p>MiS® lying surface with roller carriage (2+2): 27 cm - 82 cm</p> <p>HPL lying surface with roller carriage (2+2): 25 cm - 80 cm</p>
Bed dimensions (length x width)	approx. 2080 mm (+ max. 20 mm) x approx. 1005 mm (Design S)	approx. 2037 mm (+ max. 20 mm) x approx. 979 mm (Design S)
Recommended mattress dimensions for lying surface 190 x 200 cm	88,0 x 200,0 x 12,0 cm*	88,0 x 200,0 x 12,0 cm*
Bed weight (depending on equipment)	approx. 124 kg - 155 kg	approx. 127 kg - 158 kg
Lowermost bed position	approx. 235 mm	approx. 235 mm
Uppermost bed position	approx. 790 mm	approx. 790 mm

\* We recommend the use of Völker mattresses. If other mattresses are used, please observe the notes on p.19 f.

## Appendix | Technical data (standard design) 2/2



### Electrical data

Line voltage	100 - 240 VAC
Power consumption	290 W
Rated frequency	50 Hz / 60 Hz
Primary fuse	4.0 A
Operating time	2/18 min 10% Duty cycle guard 1080As (software)
Overload fuse	Open bus output, poly switch 0.3 A
Overcurrent trip	Common max. 10 A (hardware)
Operating temperature	+ 5 °C to + 40 °C
Storage temperature	- 40 °C to + 70 °C
Air humidity	30 % to 85 % at 30 °C - non-condensing
Air pressure	700 hPa to 1060 hPa
Operating height	Maximum 3000 m above sea level

### Audible acoustic energy

Measured value	50 dB (A)
----------------	-----------

## Appendix | Classification

Protection against electric shock	Protection class II or device with internal electrical current source 
Protection type by housing as per EN 60529	IPX4 not suitable for cleaning in automatic washing systems
Degree of protection of the applied part against electric shock as per DIN EN 60601-1	Type B 
Degree of protection against explosive substances and mixtures	The bed is not protected against explosion and should not be used in an environment in which flammable anaesthetics or flammable cleaning agents are present.

Grouping/Classification as per Regulation (EU) 2017/745 Appendix VIII Rule 13	Class I
Operating time	10 % (2 Min./18 Min.) (Operating time maximum 2 minutes / off-time 18 minutes)
Technical checks	1x annually

## Appendix | Type labels

The type plates are located on the inside of the head panel.

Raise the back section to read the type plates. See below for the symbols used.

Each bed can be clearly identified from the unique ID number on its type plate.

The structure of this ID number is as follows:



## Appendix | Service life / disposal

### Service life

The bed's expected service life is approx. 10 years.

### Disposal information

- The operator must ensure that all components to be disposed of are not infectious/contaminated.
- If the bed is scrapped, the plastic and metal parts used must be separated and disposed of properly.
- If you have any questions, contact your local authorities, waste disposal companies or our service department.

### Disposal of electrical parts

- This bed is electrically adjustable and classified as a commercial (b2b) electrical device in accordance with the WEEE Directive 2012/19/EU (implemented in Germany in the Electrical and Electronic Equipment Act).
- The electrical components used are free of prohibited harmful constituents

pursuant to the Restriction of Hazardous Substances II Directive 2011/65/EU.

- Replaced electrical components (drives, control units, hand control units etc.) from these beds are to be treated and disposed of as electrical scrap in accordance with the WEEE Directive.
- The operator of this bed is legally obliged not to dispose of its electrical components at municipal collection points, but to send them directly to the manufacturer. Völker GmbH and its service partners will accept the return of these parts. Please contact our sales team in this regard.
- These returns are subject to our general terms and conditions.

### Disposal of batteries

- Any individual batteries that have been removed but that are no longer usable must be professionally disposed of in accordance with

Directive 2006/66/EC (implemented in Germany in the Batteries Act); they must not be disposed of with general household waste.

- Contact your local waste disposal company or our service department.

In countries outside Germany/the EU, observe the applicable national regulations.

## Appendix | Dimension sheet for divided side rails 1/2

**Divided side rails 34 - 35.5 cm (back section) with MiS® lying surface**  
(depending on the height of the lying surface elements)

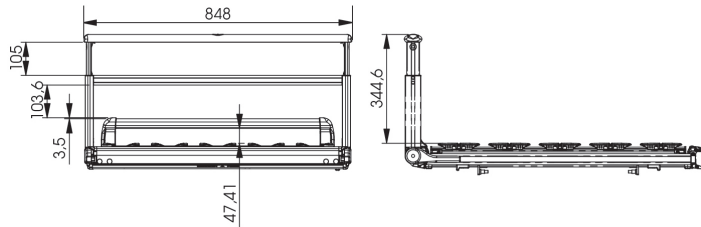

**Divided side rails 34 - 35.5 cm (back section) with HPL lying surface**  
(depending on the height of the lying surface elements)

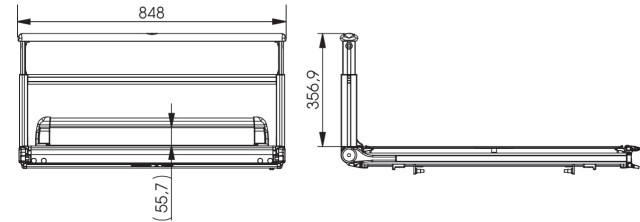

**Divided side rails 34 - 35.5 cm (upper leg section) with MiS® lying surface**  
(depending on the height of the lying surface elements)

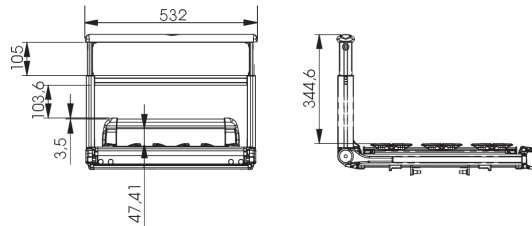

**Divided side rails 34 - 35.5 cm (upper leg section) with HPL lying surface**  
(depending on the height of the lying surface elements)

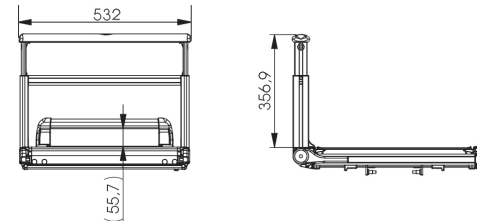

All dimensions in mm



## Appendix | Dimension sheet for divided side rails 2/2

**Divided side rails 43.5 - 45 cm (back section) with MiS® lying surface**  
(depending on the height of the lying surface elements)

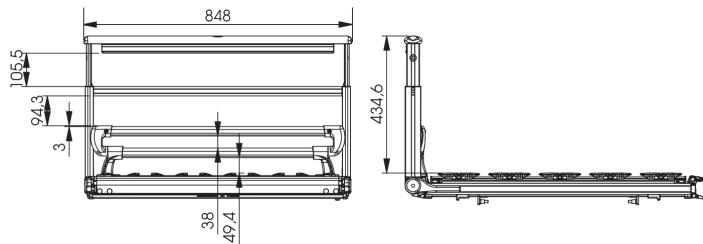

**Divided side rails 43.5 - 45 cm (back section) with HPL lying surface**  
(depending on the height of the lying surface elements)

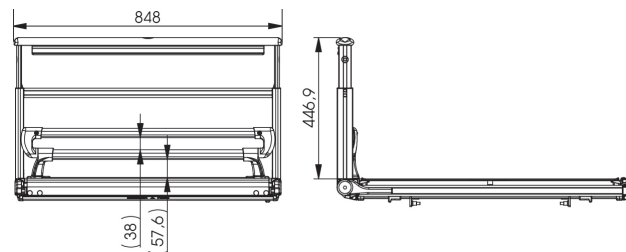

**Divided side rails 43.5 - 45 cm (upper leg section) with MiS® lying surface**  
(depending on the height of the lying surface elements)

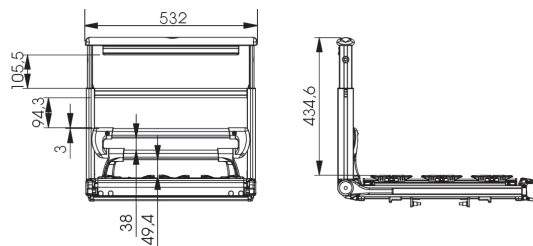

**Divided side rails 44.5 - 45 cm (upper leg section) with HPL lying surface**  
(depending on the height of the lying surface elements)

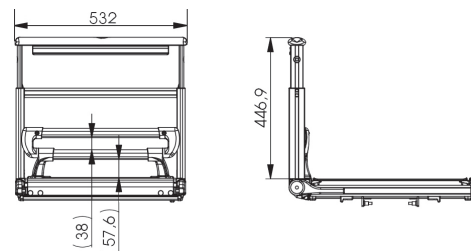

# Appendix | Dimension sheet for continuous rails

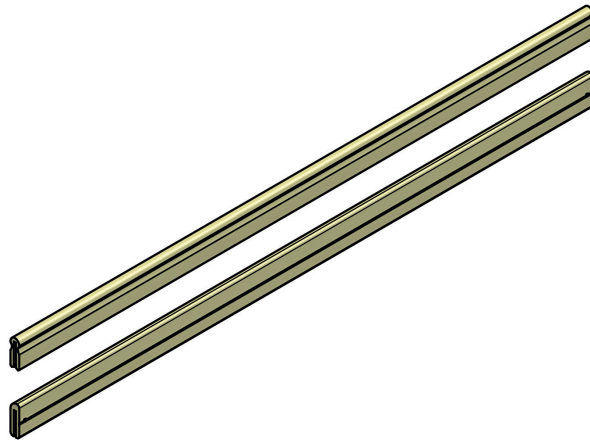
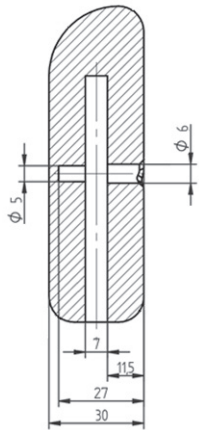
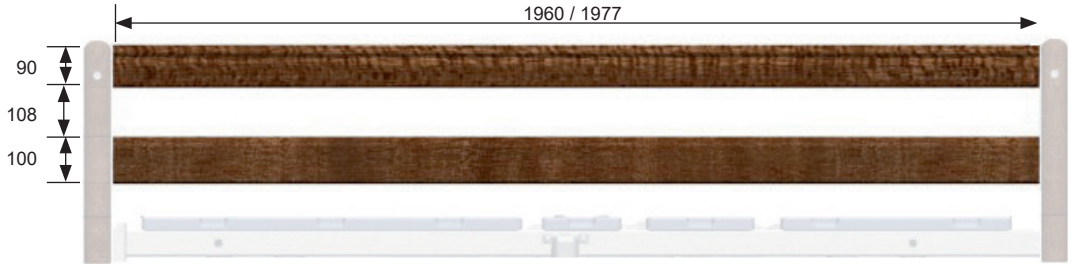
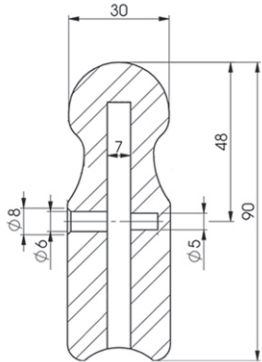

All dimensions in mm

# Manufacturer's declarations 1/4

## Guidelines and manufacturer's declarations — electromagnetic interference

The bed is intended for use in an environment as specified below. The customer or the user of the bed must ensure that it is used in an environment of this type.

<b>Emitted interference measurements</b>	<b>Compliance</b>	<b>Electromagnetic environment — guidelines</b>
HF emissions in accordance with CISPR 11	Group 1	The bed uses HF energy exclusively for its internal functions. Its HF emissions are therefore very low and it is unlikely that neighbouring electronic devices will be affected by interference.
HF emissions in accordance with CISPR 11	Class B	The bed is suitable for use in all facilities, including households and facilities directly connected to a public power grid that also supplies residential buildings.
Emissions of harmonics in accordance with IEC 61000-3-2	Class A	
Emissions of voltage fluctuations/ flicker in accordance with IEC 61000-3-3	Compliant	

## Manufacturer's declarations 2/4

### Guidelines and manufacturer's declaration — electromagnetic immunity

The bed is intended for use in the electromagnetic environment specified below. The customer or the bed user must ensure that it is used in an environment of this kind.

<b>Immunity tests</b>	<b>IEC 60601 test level</b>	<b>Compliance level</b>	<b>Electromagnetic environment — guidelines</b>
Discharge of static electricity (ESD) in accordance with IEC 61000-4-2	± 8 kV contact discharge ± 2 kV, ± 4 kV, ± 8 kV, ± 15 kV air discharge	± 8 kV contact discharge ± 2 kV, ± 4 kV, ± 8 kV, ± 15 kV air discharge	Floors must be made of wood or concrete, or should be covered with ceramic tiles. If the floor is covered with synthetic material, relative humidity must be at least 30%.
Electrical fast transients/ bursts in accordance with IEC 61000-4-4	± 2 kV 100 kHz repetition frequency	± 2 kV 100 kHz repetition frequency	The quality of the supply voltage must be that of a typical commercial, clinical or residential environment.
Surges in accordance with IEC 61000-4-5	± 0.5 kV, ± 1 kV differential mode ± 0.5 kV, ± 1 kV, ± 2 kV common mode	± 0.5 kV, ± 1 kV differential mode ± 0.5 kV, ± 1 kV, ± 2 kV common mode	The quality of the supply voltage must be that of a typical commercial, clinical or residential environment.
Voltage dips, short interruptions and fluctuations in the supply voltage in accordance with IEC 61000-4-11	0% UT for ½ cycle at 0°, 45°, 90°, 135°, 180°, 225°, 270° and 315° 0% UT for 1 cycle at 0° 70% UT for 25 cycles at 50 Hz at 0° 0% UT for 250 cycles at 50 Hz	1% UT for ½ cycle at 0°, 45°, 90°, 135°, 180°, 225°, 270° and 315° 0% UT for 1 cycle at 0° 70% UT for 25 cycles at 50 Hz at 0° 0% UT for 250 cycles at 50 Hz	The quality of the supply voltage must be that of a typical commercial, clinical or residential environment. If the bed user requires continued function even in the event of interruptions to the energy supply, it is recommended that the bed be powered by an uninterruptible power supply or a battery.
Magnetic field at the supply frequency (50/60 Hz) in accordance with IEC 61000-4-8	30 A/m 50 Hz	30 A/m 50 Hz	Magnetic fields at mains frequency should correspond to the typical values found in the commercial, clinical or residential environment. Devices that generate magnetic fields should be used at a distance of at least 15 cm from the bed.

COMMENT: UT is the AC mains voltage before application of the test level.

## Manufacturer's declarations 3/4

### Guidelines and manufacturer's declaration — electromagnetic immunity

The bed is intended for use in the electromagnetic environment specified below. The customer or the bed user must ensure that it is used in an environment of this kind.

Immunity tests	IEC 60601 test level	Compliance level	Electromagnetic environment — guidelines
Conducted HF interference on the power cable in accordance with IEC 61000-4-6 (no patient connections, DC connections or signal connections are present near the bed)	3 Vrms 150 kHz to 80 MHz 6 Vrms in ISM and amateur radio frequency bands between 150 kHz and 80 MHz 80% AM at 1 kHz	3 Vrms 150 kHz to 80 MHz 6 Vrms in ISM and amateur radio frequency bands between 150 kHz and 80 MHz 80% AM at 1 kHz	<p>The bed is suitable for use in industrial, clinical and residential environments, but not in rooms containing magnetic resonance imaging (MRI) equipment or high-frequency surgical equipment.</p> <p>Electronic devices must be used at a distance of at least 30 cm from the bed. The field strength of fixed radio transmitters must be lower than the compliance level for all frequencies in accordance with an on-site evaluation.</p> <p>Interference may occur near devices bearing this symbol.</p> 
Radiated HF interference in accordance with IEC 61000-4-3	10 V/m 80 MHz to 2.7 GHz 80% AM at 1 kHz	10 V/m 80 MHz to 2.7 GHz 80% AM at 1 kHz	

## Manufacturer's declarations 4/4

<p>High-frequency electromagnetic fields in the immediate vicinity of wireless communication devices in accordance with IEC 61000-4-3</p>	<p>TETRA 400 (380 to 390 MHz, 27 V/m)          GMRS 460; FRS 460 (430 to 470 MHz, 28 V/m)          LTE Band 13, 17 (704 to 787 MHz, 9 V/m)          GSM800/900; TETRA 800; iDEN 820; CDMA 850; LTE Band 5 (800 to 960 MHz, 28 V/m)          GSM 1800; CDMA 1900; GSM 1900; DECT; LTE Band 1,3,4,25; UMTS (1700 to 1990 MHz, 28 V/m)          Bluetooth; WLAN 802.11 b/g/n; RFID 2450; LTE Band 7 (2400 to 2570 MHz, 28 V/m)          WLAN 802.11 a/n (5100 to 5800 MHz, 9 V/m)</p>	<p>TETRA 400 (380 to 390 MHz, 27 V/m)          GMRS 460; FRS 460 (430 to 470 MHz, 28 V/m)          LTE Band 13, 17 (704 to 787 MHz, 9 V/m)          GSM800/900; TETRA 800; iDEN 820; CDMA 850; LTE Band 5 (800 to 960 MHz, 28 V/m)          GSM 1800; CDMA 1900; GSM 1900; DECT; LTE Band 1,3,4,25; UMTS (1700 to 1990 MHz, 28 V/m)          Bluetooth; WLAN 802.11 b/g/n; RFID 2450; LTE Band 7 (2400 to 2570 MHz, 28 V/m)          WLAN 802.11 a/n (5100 to 5800 MHz, 9 V/m)</p>	<p>Devices that use the listed radio services must be operated at a distance of at least 30 cm from the bed.</p>
---	--	--	--

COMMENT 1: The higher frequency range applies at 80 MHz and 800 MHz.

COMMENT 2: These guidelines may not be applicable in all cases. The propagation of electromagnetic variables is affected by the absorbent and reflective properties of buildings, objects and people.

a The field strength of fixed transmitters, e.g. base stations for cordless phones and mobile radios, amateur radio stations, AM and FM radio and TV broadcasters, cannot in theory be predicted with any accuracy. A study of the site should be considered to determine the electromagnetic environment with regard to the location of the fixed transmitter. If the field strength measured in the location in which the bed is used exceeds the aforementioned compliance level, the bed must be monitored in order to verify that it is working as intended. If abnormal performance characteristics are observed, additional measures, such as reorientation or relocation of the bed, may be required.

## Information on electromagnetic compatibility (EMC)

Electromagnetic compatibility (EMC) refers to the ability of a technical device to refrain from affecting other devices with unwanted electrical or electromagnetic effects and to resist interference from other devices.

Appropriate construction and design are key to ensuring the electromagnetic compatibility of electrical equipment. The documentation and confirmation of resistance to interference and sufficiently low levels of emitted interference are regulated by EMC guidelines and EMC standards.

To ensure fault-free operation of the bed, please note the following:

- In isolated cases, strong interference can cause failure of adjustment functions, unwanted bed movements, continued adjustment even after release of a button, unwanted changes to the lock status or loss of height information. If effects of this nature are observed, try to increase the distance between the bed and the source of the interference, and to power the

device causing the interference and the bed from different circuits. Unwanted movements can be stopped by pressing any button on a control unit (provided it is unlocked). Incorrect locking statuses can be corrected by pressing the appropriate buttons. A loss of height information indicates a failure of the height adjustment function. In this case, press the "Frame up" and "Frame down" buttons simultaneously and hold for more than 10 seconds until movement ceases. This reference run updates the height information.



**WARNING** The bed must not be placed directly adjacent to or stacked with other devices. If operation near to or stacked with other devices is necessary, bed operation must be monitored. Intended function in the employed arrangement must also be verified.

- Only Völker original electrical spare parts must be used for repair and service work. Otherwise the aforementioned requirements may not be met. A list of electrical components can be found in the service handbook.
- Devices that emit radiation, such as mobile phones, must only be used at a minimum distance of 30 cm from the bed.
- Please also note the guidelines in the manufacturer's instructions.

**Technical check of Völker hospital and healthcare beds in accordance to German standards and safety regulations incl. measurements required**

Project, address, customer no.:	Name of technician:			
Type of best product, location of the best:				
Bed identification (in accordance to DIN EN 62593)				
Date of check:				
<b>Kind of check</b>	<b>Component to be checked</b>	<b>Annually</b>	<b>Accepted</b>	<b>Not accepted</b>
Visual inspection	Inscription on device readable Instructions for use available Base frame Lying surface, wing and spring elements (if existing) Trapeze bar adapter, infusion bar adapter Power supply cable, plug or charger, charging connection Strain relieve, bend protection, cable hook Connecting cable, plug-in contacts, blind plugs Positioning (spacing 1 mm) and sensor cabling (only /Vis-a-/Vis-bed) Housing (motor, control electronics) Hand control (housing, cable) Nurse keypad, nurse hand control (housing, cable) Trapeze bar, assist rail (infill panel (side rail centre), additional accessories) Transverse motor and cover, head and foot ends Castors Wall buffer, wheel (if existing) Side rails including telescopic section, if applicable HL,Low-elevation; check screw/locking (only for 5380) Locking devices Deformation Abrasions	B* B* B* B*/S* B*/S* B* B* B* B* B* B* B* B* B* B* B* B* B* B* B* B* X* X* X*		
Functional inspection of side rails including telescopic section, if applicable	Back section, upper leg section, lower leg section, height adjustment, Trendelenburg position, leg adjustment (only for /Vis-a-/Vis-bed) - approach all end positions Angle limitation (back section to upper leg section - 90°) Adjustment lower leg section (rastomat/hydraulic/support plate) CFR function (if existing) Brake (electrical or mechanical) <i>only for hospital beds and S 280/S 310/S 380/S 282/S 382 (Vis-a-/Vis)</i>	X* X* X* X* X*		
Functional inspection of drives nurse keypad/nurse hand control	Mechanical release (only for electrical brakes of hospital beds) 9 V battery (only for beds with Okli-Iconomat except S 980-1/WS 981) Replaced (yes/no) Trapeze bar handle and belt (if existing) Replaced (yes/no)	X* A2*  A* B*		
Functional inspection miscellaneous	Bed extension (if existing) Bedding storage/bedding drawer (if existing) Inspection of the adhesive joints on headboard and footboard (if existing)	B* B* B*		
Comment				
Leakage current by means of alternative measurement ≤ 500 µA (in accordance to DIN EN 62593) Potential equalization impedance < 0,2 Ohm (if existing) Measuring instrument SN		µA		
		Ω		
<b>Total result of the inspection:</b>	Next regular inspection:			
Signature of technician:				

A\*: To be replaced every 5 years for handles (if used for H with Völker RRP) in nursing home, every 2 years for H with RF in hospital beds, every 2 years for H with RF for cleaning in automatic bed washing systems. A2\*: To be replaced every two years. B\*: Check for damage. F\*: Check function of motor and end switches, does the motor switch off when reaching the end position? S\*: Check for correct fit. X\*: General function control



# Spare part order



Address: \_\_\_\_\_  
 \_\_\_\_\_  
 Name of the ordering party: \_\_\_\_\_  
 Street address: \_\_\_\_\_  
 Zip code/city/country: \_\_\_\_\_  
 Telephone number: \_\_\_\_\_  
 Customer number: \_\_\_\_\_  
 Customer order number: \_\_\_\_\_  
 Purchase order date: \_\_\_\_\_  
 Signature: \_\_\_\_\_

(Please, to fill in the form use block letters)

Völker GmbH  
 Service  
 Wullener Feld 79  
 58454 Witten/Germany

Tel.: +49 2302 96096-62  
 Fax: +49 2302 96096-66  
 E-Mail: service@voelker.de

- Shipping address, if different from the billing address
- Billing address, if different from the shipping address

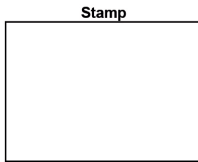

Address: \_\_\_\_\_  
 \_\_\_\_\_  
 Attention of: \_\_\_\_\_  
 Street address: \_\_\_\_\_  
 Zip code/city/country: \_\_\_\_\_

Please fill out all the information carefully and complete the form in its entirety, otherwise we may have problems in delivering and processing this order.

MODEL (Bed-type)	SERIAL NO. (Identification label inside of the bed-head)	SPARE PART DESCRIPTION	ITEM NUMBER	QUANTITY

## Available accessories

If you have any questions about accessories for this bed or if you wish to order accessories, please contact Völker GmbH.



**VÖLKER**

Völker GmbH

Wullener Feld 79 · D-58454 Witten/Germany

Phone +49 2302 960 96-0 · Fax +49 2302 960 96-16

[www.voelker.de](http://www.voelker.de) · [info@voelker.de](mailto:info@voelker.de)