

# VÖLKER



Instructions for use  
S 966 hospital bed



**G181 instructions for use  
HB-RD-000046 Rev.7**



**Völker S 966 hospital bed, models from 08/2019  
These instructions for use are valid from 05/2021**

© by Völker GmbH

Manufacturer:  
Völker GmbH  
Wullener Feld 79  
58454 Witten  
GERMANY

Tel.: +49 2302 96096-0  
Fax: +49 2302 96096-16  
Email: [service@voelker.de](mailto:service@voelker.de)  
Website: [www.voelker.de](http://www.voelker.de)

All rights reserved.

Reprinting - whether in full or in part - is not permitted.

We reserve the right to make changes due to technical developments.

The contents of this document are subject to change without prior notice.

Customers are advised to contact the relevant person before placing an order.

Technical documentation can be made available on request.

For the electronic version of these instructions for use in PDF format, visit [www.voelker.de](http://www.voelker.de).

# Table of contents

Version, Legal notice	3	Operation   Hand control unit   Under-bed light	35
Table of contents	4		
Notes   General information	5	Operation   Nurse keypad   Adjusting the back section	36
Notes   General safety instructions	6		
Notes   Designated purpose	8	Operation   Nurse keypad   Adjusting the upper leg section	37
Notes   General provisions, user qualifications/ training, other requirements	9	Operation   Nurse keypad   Adjusting lying surface height	38
Functional description   Overview of S 966 hospital bed	10	Operation   Nurse keypad   Hand control unit lock, transport position, cleaning position, washing system position	39
Functional description   Hand control units	11		
Functional description   Nurse keypads	13	Operation   Nurse keypad   Under-bed light, comfort seating position, lying surface flat and horizontal, egress aid	40
Functional description   Accessories	16		
Functional description   Configurations	18	Operation   Nurse keypad   Resuscitation position, Trendelenburg position and reverse Trendelenburg position	41
Putting the bed into service   General operating instructions	20	Operation   Nurse keypad   Memory functions	42
Commissioning   Preparation	21	Operation   Rapid lowering of the back section/CPR function	43
Commissioning   Battery use   Decommissioning	22	Operation   Bed extension	43
Commissioning   Functional checks	23	Operation   Castors	44
Operation   Side rails   General safety instructions	24	Cleaning and disinfection	45
Operation   Moving split side rails	25	Maintenance   Staff qualifications, Safety instructions   Maintenance schedule	46
Operation   Fixed split side rails	26	Technical inspection	47
Operation   Hand control unit   Adjusting the back section	27	Troubleshooting   Table of faults	48
Operation   Hand control unit   Adjusting the upper leg section	28	Type plates   Symbols used	49
Operation   Hand control unit   Adjusting the lower leg section (manually)	29	Technical data   Classification	50
Operation   Hand control unit   Adjusting lying surface height	30	Service life/disposal	51
Operation   Hand control unit   Setting the comfort seating position	31	Dimension sheets S 966 hospital bed	52
Operation   Hand control unit   Setting the reverse Trendelenburg position	32	Manufacturer's declarations	53
Operation   Hand control unit   Setting the egress aid	33	Information on electromagnetic compatibility (EMC)	55
Operation   Hand control unit   Setting a horizontal lying surface position	34	Forms	56
		Available accessories	58



### General information

You have purchased a bed from Völker GmbH. This bed was constructed in conformity with the applicable national and international standards and regulations and in accordance with current technological standards.

Völker beds meet safety and functional requirements (DIN EN 60601-1 and DIN EN 60601-2-52). They are tested in accordance with harmonised standards and bear the CE mark documenting that the essential requirements for medical devices have been met.

Please read the general safety instructions (p. 6). Please also observe the further notes on the following pages (particularly with regard to any warranty claims).

### Configurations

The bed can be supplied in various configurations. For further information, please refer to the "Configurations" section (p. 18).

### Copyright

The instructions for use may only be handed to third parties with the written consent of Völker GmbH. All documents are protected under copyright law.

### Warranty and liability

We provide a 2-year warranty on all our products. This is described in the order confirmation.

We reserve the right to make technical changes without prior notice as part of further development of the beds referred to in these instructions for use.

All information is non-binding.

Subject to printing errors.

We accept no liability for any damage or malfunction caused by operator error or failure to comply with these instructions for use.

The illustrations in these instructions for use do not necessarily correspond to the technical design.

## Notes | General safety instructions 1/2

 **Warning signs: Information marked with this symbol must be read and strictly observed.**

 **CAUTION** indicates potentially dangerous situations that could cause minor injury.

 **DANGER** indicates an imminent danger that could cause serious injury or death.

 **WARNING** indicates potentially dangerous situations that could lead to serious injury or death

 **NOTE** warns of possible material damage.

### Before putting the bed into service for the first time

Before the bed is put into service for the first time, these instructions for use must be read in detail by care staff.

Before the bed is put into service, care staff must be instructed in handling the bed in accordance with the instructions for use. In addition, any potential hazards that may arise despite proper operation of the bed must be pointed out in detail.

### Before and during use

Before each use of the bed, the user must check that it is in good working order and that safe use is guaranteed (function check, p. 23).

 **WARNING** No adjustments or modifications may be made to Völker products without the permission of the manufacturer. This automatically voids all warranty claims and CE conformity.

 **WARNING** If other devices equipped with cables, air hoses or similar are to be operated in the area around the bed, it is important to ensure that these cables etc. are routed so that they cannot become trapped in the bed's moving parts and be damaged.

### Bed position

 **CAUTION** To avoid injury from falls, we recommend always moving the bed to its lowest position with the castors fixed when the patient is sleeping in the bed (except when undertaking care measures).

### Transporting the bed

 **CAUTION** When transporting the bed, it is important to ensure that the mains cable does not come into contact with the ground. The lying surface must be moved to an ergonomically

comfortable height. The bed should only be moved on solid surfaces. Do not attempt to push it over obstacles that are higher than 2 cm. The angle of inclination of the floor must not exceed 6°.

### Securing the bed

 **CAUTION** If the bed is not being transported, the castors must always be secured and, if applicable, locked, since the patient may use the bed as a support when standing up or lying down. If the bed rolls away due to unbraked castors, this could result in a serious fall. After the castors have been secured, check to ensure that the bed is actually stationary.

The bed may also be in an unbraked position after being put into service or brought back into service. Therefore, it must subsequently be checked to ensure that the castors are properly secured.

 **NOTE** Please note that the brakes are most effective on dry, clean and non-slip floors.

### One-sided bed load

 **NOTE** Nobody except the patient must sit on the bed (visitors must not sit on the edge of the bed) to prevent the bed being loaded on a single side.

### Side rails

 **WARNING** If a patient's physical or mental condition makes it necessary to use the side rails to prevent them from falling out of bed, observe the safety measures below:

- The legal admissibility of using the side rails must be ensured.
- The side rails must only be operated by trained care staff.
- Ensure that no body parts are protruding through the side rails when the electrical lying surface adjustment function is activated.
- Ensure that the side rails (or parts thereof) are either fully raised and locked or fully lowered.
- If the side rails must be used due to the patient's mental condition, it is important to ensure that the hand control unit is kept locked and out of their reach. It is also strongly recommended to use the protective covers for the side rails.

 **DANGER** There is a risk of injury if the aforementioned safety measures are not observed.

### Height adjustment

**⚠ DANGER** Always ensure that no persons, limbs, pets, bedding or other objects are between the bed frame and the undercarriage/floor when adjusting the bed.

**⚠ DANGER** All functions must be locked if any bed movement could constitute a hazard.

### Accessories

**⚠ WARNING** Only original Völker accessories must be used without exception! The operator accepts responsibility for the use of other accessories not approved by Völker GmbH.

### Use of oxygen equipment

**⚠ DANGER** Never use the bed in an oxygen tent or in potentially explosive atmospheres (possible presence of flammable gases or vapours).

The device may be used provided that the O<sub>2</sub> concentration is guaranteed not to increase (e.g. by information in the instructions for use for the device used) to the extent that a risk of explosion arises during use or due to a malfunction.

### Side rail spacers

When using the side rail spacers, please observe the separate instructions for use for this accessory. During technical checks, the side rail spacers must also be checked with regard to the dimensions of the side rails.

### Cleaning and disinfection

To maintain the functionality of the bed, the bed must be cleaned, disinfected and tested as soon as possible after each use so that it can be used again immediately and without risk.

Hazards may arise due to improper cleaning/disinfection of the bed.

### Maintenance and repairs

Any person tasked with maintenance and repair must have participated in at least one training session on service tools conducted by Völker GmbH, must have read the safety regulations and the service handbook, and must be qualified in accordance with the applicable national regulations.

After maintenance work or repairs have been carried out, the affected parts or functions must be subjected to a technical check. During this process, it must also be established whether the bed can be used without risk to patients, users or third parties in accordance with the specifications.

The technical check must be conducted at least once per year and when the bed has not been used for a long period.

Any damage, such as wear and tear, loose screws or breaks, must be remedied immediately.

### Electromagnetic and electrostatic interference

Model S 966 beds meet EMC requirements in accordance with the German act on the electromagnetic compatibility of equipment (EMVG).

Only original Völker replacement PARTS, cables and accessories may be used on the bed. Otherwise the EMC behaviour may be impaired, which may result in the bed and other devices in the area around the bed malfunctioning.

### Serious incidents

Serious incidents that occur in connection with the operation of the bed must be reported immediately to the responsible authorities of the respective country and to Völker GmbH.

### Applied parts

Applied parts are parts of a medical electrical device (ME device) that necessarily come into physical contact with the patient under normal conditions of use so that the ME device or an ME system can fulfil its function (DIN EN 60601-1).

For the S 966 hospital bed, these are:

- Hand control unit
- Side rails
- Head/foot ends
- Lying surfaces
- Frame

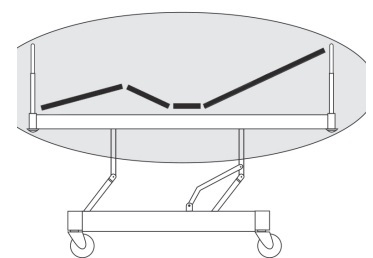

Schematic representation of the application area.

# Notes | Designated purpose

## Intended use

The Völker model S 966 bed is a bed for medical use. It is intended for accommodating patients in clinical rooms of hospitals, clinics and care facilities (application environments 1, 2, 3 and 5 in accordance with DIN EN 60601-2-52).

The bed may only be operated under the conditions described in these instructions for use. Any other use is considered improper.

In all care environments, the operator shall consider the patient's mental and physical condition and the resulting risks to the operation of this medical device before using the bed.

Certain types of care environments (e.g. psychiatric units, prison units, paediatrics) may have special requirements for the type of patient. The operator must assess the use of the bed in these environments.

The bed is intended to be used for patients with a physical height of 146 cm or above, a body weight of 40 kg or above, and a body mass index (BMI) of 17 or above. The safe working load of the bed is 270 kg.

To calculate maximum patient weight in accordance with DIN EN 60601-2-52 in application environments 1 and 2 (intensive and acute care), 20 kg must be deducted from the safe working load for the weight of the mattress and a further 45 kg for the accessories and the load they bear.

When the bed is used in application environments 3 and 5 (long-term and outpatient care), the values to be taken into account are 20 kg for the mattress and 15 kg for the accessories and the load they bear.

Any use of the Völker bed which deviates from this designated purpose is excluded from potential liability.

Maximum patient weights are summarised in the following table.

Model S 966	
Safe working load: 270 kg	
Maximum patient weight	
Application environment 1, 2* 205 kg	Application environment 3, 5* 235 kg

## Contraindications

This bed is only suitable for patients who do not fall below the following body dimensions/weights:

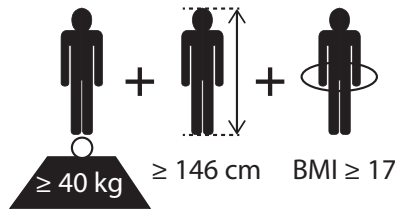

BMI is an index value derived from body weight and height. BMI is calculated using this formula:

$$BMI = \frac{\text{Body weight} \left[ \frac{\text{kg}}{\text{m}^2} \right]}{\text{Height}^2}$$

## Side effects

If the patient lies down for a longer period of time, pressure ulcers can occur without appropriate countermeasures.

## Improper use

Improper use may result in hazards.

For example, this may include:

- Improper operation of electrical functions and uncontrolled positioning
- Operation of the bed by the patient without prior instruction
- Pulling cables to move the bed
- Pulling cables to disconnect electrical connectors
- Use of the bed on sloping surfaces with an incline of more than six degrees (the bed brakes are designed for a maximum inclination of ten degrees)
- Attempting to move the bed with the brakes applied
- Using the bed to transport a patient in a vehicle
- Overloading the bed beyond its specified safe working load

**CAUTION** If it is impossible to avoid accommodating persons under 146 cm in height in the beds, the protective covers for the side rails must be used. This also applies when the bed is used by weak or confused persons.

**WARNING** If operation near to or with other stacked devices is necessary, it must be ensured that bed operation is monitored and that intended use is verified in the arrangement used.

\* Except in the vicinity of high-frequency surgical equipment and in rooms containing magnetic resonance imaging (MRI) equipment.

# Notes | General provisions, user qualifications/training, other requirements

## General provisions

The bed may be operated and used only in accordance with its designated purpose and in compliance with the applicable regulations, the generally accepted rules of technology as well as the occupational safety and accident prevention regulations. The bed must not be operated when faulty, as it could endanger patients, care staff or third parties.

## User qualifications

The bed may be operated only by persons who can guarantee proper handling based on their education/training or knowledge and experience.

## User training

Völker GmbH or its representatives will provide a basic introduction to operating the bed for care staff at the customer's request. Participation in such training by care staff can be confirmed in a form provided for this purpose and authenticated by Völker GmbH with name, date and signature.

Patients must be instructed in the use of the bed by care staff before the hand control unit is activated.

## Other requirements

Anyone tasked with putting the bed into service, operating or preparing the bed must have these instructions for use to hand (on paper or in electronic form) and must have read them.

The following safety instructions must always be accessible to care staff to avoid operating errors and to ensure the smooth operation of the bed.

## Setup conditions

The bed is approved for operation in dry rooms only (see the section on technical data). A power supply and, if necessary, a potential equalisation terminal are required to operate the bed in the setup room. It is advisable to connect the bed to a potential equalisation terminal if one is available and this is permitted by the in-house installations.

## Flooring requirements

In recent years patients and residents have become heavier and demands on hospital and care beds have increased steadily. Völker has tackled this issue by raising the safe working load of the beds. However, it is not only the beds that are exposed to higher loads, but also statics and flooring.

For this reason, we recommend that flooring designed for these loads is used in areas where the beds are situated. This means flooring that is classified in accordance with DIN EN ISO 10874 and that has been laid by professionals (flooring for public or commercial areas that are subject to medium or heavy traffic).

## Functional description | Overview of S 966 hospital bed

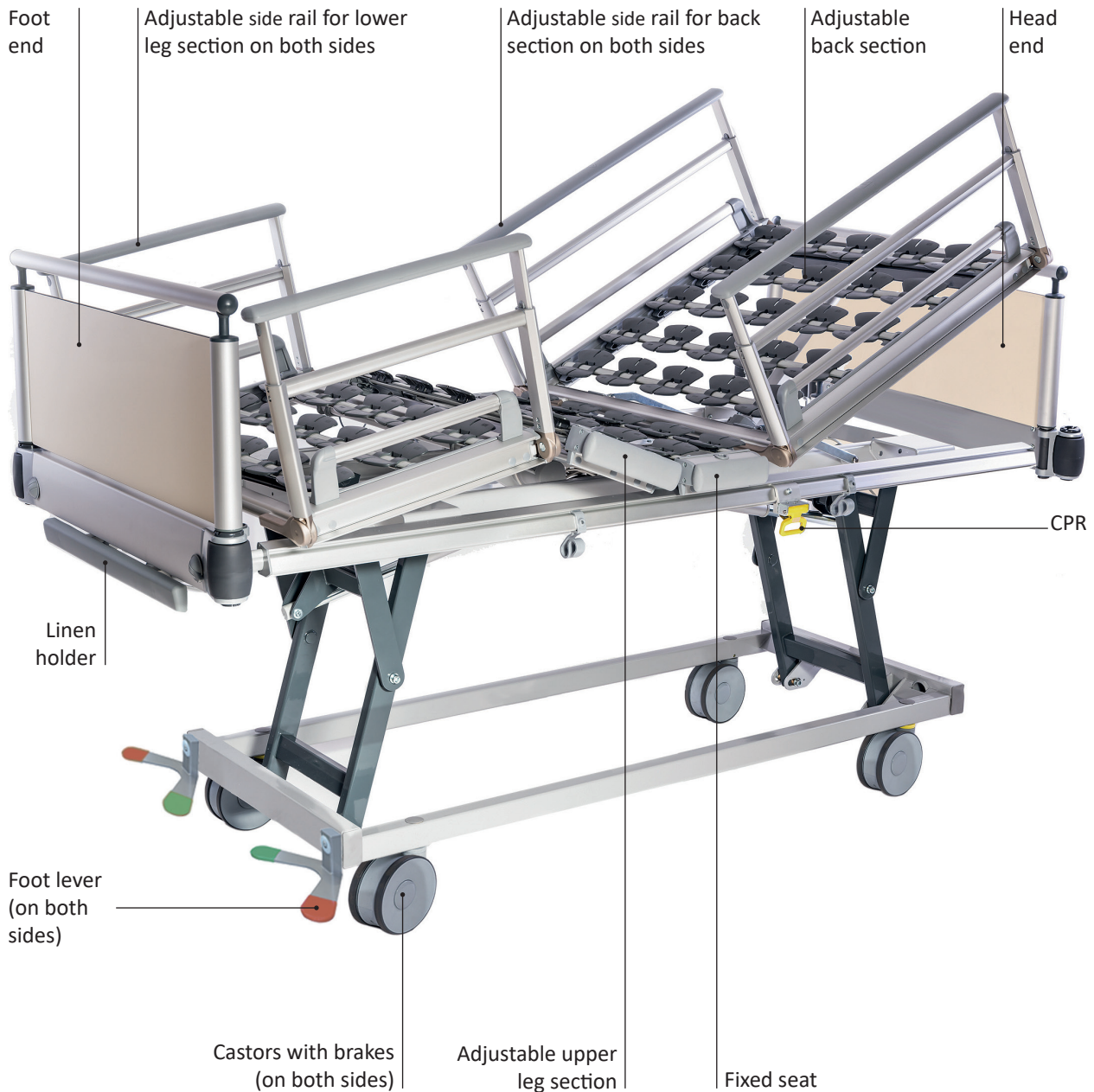



## Functional description | Hand control unit 1/2 - E2535, E2554 transverse

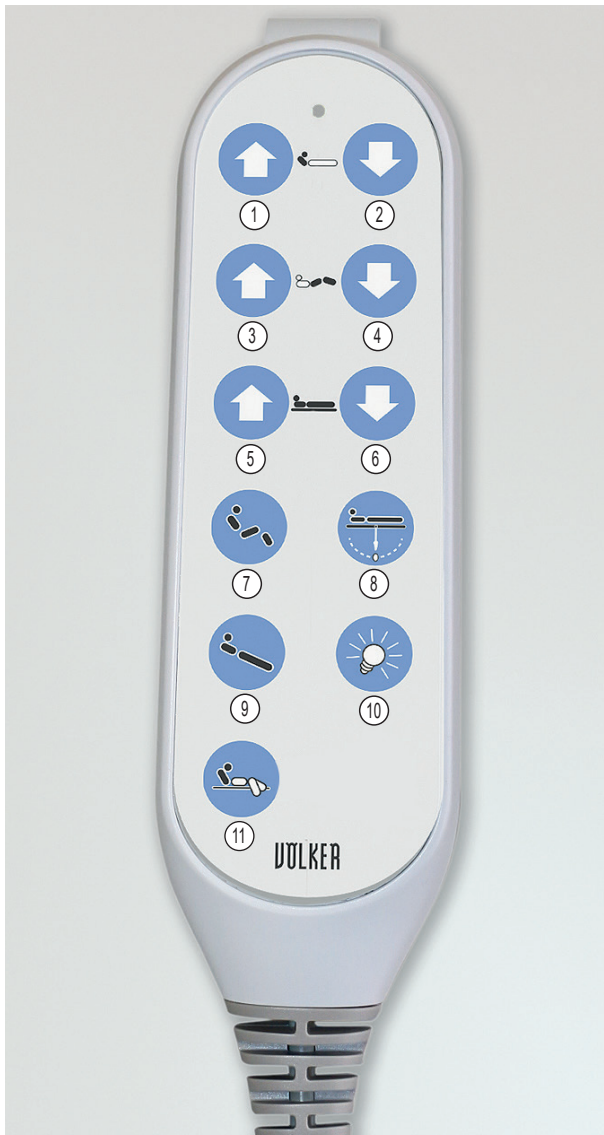

**⚠ WARNING** When adjusting the bed with the side rails raised, ensure both that the patient does not come into contact with the side rails and that their body parts, or those of other persons, are not protruding through the side rails and are not located between the lying surface and the undercarriage/floor.

- 1 Back section up
- 2 Back section down
- 3 Upper leg section up
- 4 Upper leg section down
- 5 Lying surface up
- 6 Lying surface down
- 7 Comfort seating position
- 8 Lying surface flat and horizontal
- 9 Reverse Trendelenburg position
- 10 Under-bed light (depending on configuration)
- 11 Egress aid

E2535 hand control unit

The E2535 standard hand control unit is also available in a transverse version (E2554).

This offers the same range of functions as the standard model.



E2554 transverse hand control unit

## Functional description | Hand control unit 2/2

### Hand control unit

Hand control units are connected to the bed by a plug-in connector. The connection sockets are located on both sides under the seat part.



The hand control units have a hook on the back so that they can be hung on e.g. the side rails or the bed frame.



The transverse version of the hand control unit is attached to the moving split side rails with a clip.

### Hand control unit lock

The hand control units can be unlocked and locked on the back using a locking key.

Activating the hand control unit lock locks all the functions of the respective hand control unit.

If the bed functions cannot be operated, please check whether the hand control unit lock has been activated.



Locking switch on the back

The unit is unlocked/locked by turning the locking switch to the right/left with the key.



Hand control unit unlocked    Hand control unit locked

The hand control unit lock must only be used by care staff. The locking key should therefore always be kept separate from the hand control unit.

### Meaning of the LED

The LED at the centre top of the hand control unit is permanently lit while the bed is connected to the power supply to make it easier for staff and patients to locate the unit.

### Hand control unit connection

The hand control is connected to the bed by a plug-in connector. The connection sockets are located on both sides under the back section.



Connection socket, on both sides

When not in use, the connection sockets must be sealed with blind plugs.



## Functional description | Nurse keypad 1/3 (standard)



- |                                   |   |
|-----------------------------------|---|
| 1 Battery charge status indicator | 11 Lying surface down*                          |
| 2 Mains power supply indicator    | 12 Lying surface low                            |
| 3 Lock back section               | 13 Lock hand control unit                       |
| 4 Back section up                 | 14 Under-bed light (depending on configuration) |
| 5 Back section down               | 15 Comfort seating position                     |
| 6 Lock upper leg section          | 16 Lying surface flat and horizontal*           |
| 7 Upper leg section up            | 17 Egress aid                                   |
| 8 Upper leg section down          | 18 Trendelenburg position*                      |
| 9 Lock lying surface              | 19 Reverse Trendelenburg position               |
| 10 Lying surface up*              | 20 Memory function for egress aid               |

\* Press twice to activate automatic mode (depending on country).

### Meaning of the LEDs

LED ① indicates the battery charge status.

LED ② indicates that the bed is connected to a power supply.

LEDs ③, ⑥ and ⑨ indicate that the relevant function is locked.

LED ⑬ indicates that all hand control units connected to the bed are fully locked.

LED ⑭ indicates whether the under-bed light is switched on.

**⚠ WARNING** When adjusting the bed with the side rails raised, ensure both that the patient does not come into contact with the side rails and that their body parts, or those of other persons, are not protruding through the side rails and are not located between the lying surface and the undercarriage/floor.

## Functional description | Nurse keypad 2/3 (advanced)



- |                                   |   |
|-----------------------------------|---|
| 1 Battery charge status indicator | 14 Transport position*  |
| 2 Mains power supply indicator    | 15 Cleaning position  |
| 3 Lock back section               | 16 Washing system position*                                   |
| 4 Back section up                 | 17 Under-bed light (depending on configuration)               |
| 5 Back section down               | 18 Comfort seating position                                   |
| 6 Lock upper leg section          | 19 Lying surface flat and horizontal*                         |
| 7 Upper leg section up            | 20 Egress aid   |
| 8 Upper leg section down          | 21 Resuscitation position*                                    |
| 9 Lock lying surface              | 22 Trendelenburg position*                                    |
| 10 Lying surface up*              | 23 Reverse Trendelenburg position                             |
| 11 Lying surface down*            | 24 Memory function for washing system position and egress aid |
| 12 Lying surface low              |   |
| 13 Lock hand control unit         |   |

\* Press twice to activate automatic mode (depending on country).

The nurse keypads allow the back section ①, upper leg section ② and lying surface height ③ adjustment functions to be locked. These locks are transferred to all hand control units that are connected to the bed with cables.

All connected hand control units can also be fully locked using the keypads ④.

The nurse keypads are connected directly to the control box.

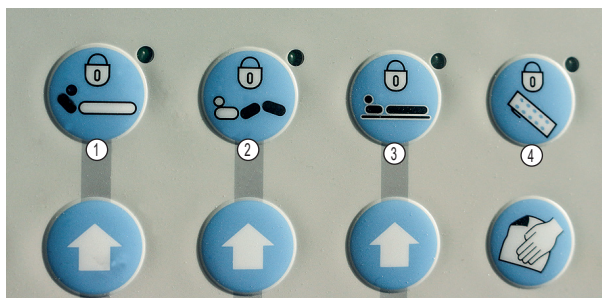

## Functional description | Nurse keypad 3/3, linen holder

### Linen holder

The nurse keypad can be found in the linen holder.



The keypad can also be hung on the foot end, if preferred. However, make sure that it cannot be accessed by the patient.



The linen holder must always be closed when not in use to prevent damage.



- ⚠ **NOTE** The load of the bedding tray may not exceed 20 kg.



## Functional description | Accessories 1/2

### Mattresses

To minimise the risk of injury, please only use Völker mattresses with dimensions that match the Völker lying surfaces.

-  **DANGER** There is a risk of suffocation if mattresses are used that do not correspond to the specifications.
-  **DANGER** The height of the raised side rails above a mattress must always be greater than or equal to 220 mm. If not, the patient may accidentally fall out of the bed. Please note that the thickness of the mattress directly affects this.





### Trapeze bar

Völker provides a wide selection of accessories for the greatest possible flexibility. The beds are fitted with accessory holders as standard, e.g. for drip stands and trapeze bars.



For more information regarding accessories, please refer to our current brochures or our website at [www.voelker.de](http://www.voelker.de). Our staff will be happy to inform you of the accessories available for your model of bed.

-  **WARNING** Only the trapeze bars specified in the list of accessories may be used.
-  **WARNING** Ensure that the trapeze bar has been inserted fully into the holder and is properly engaged. Please note: The maximum safe working load for the trapeze bar is 75 kg.





Holders for accessories such as trapeze bars and IV holders are situated on the inside of the head panel.

Place the Ø 34-mm trapeze bar into the holder and align it using the grooved pin.



A holder for a patient's trapeze bar with an external diameter of 40 mm can be attached depending on the configuration.

-  **WARNING** The trapeze bars must not protrude beyond the outer edge of the bed.
-  **WARNING** The trapeze bar and drip stand must never be used by the patient as an entry or egress aid (e.g. when getting out of a wheelchair).

### Side rail spacers

The side rail spacers close the central gap between the moving split side rails on Völker beds to create a continuous side rail solution.



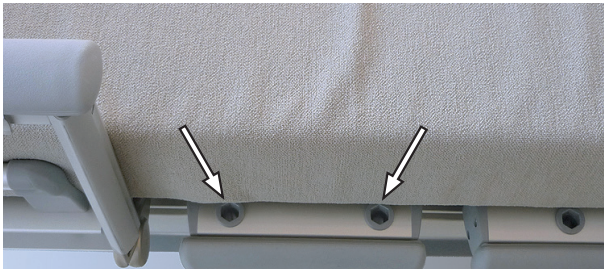

The side rail spacers are inserted into the support sleeves on the upper leg section.

Check whether the pendulum lock is fully engaged by attempting to pull the side rail spacers out upwards. If this succeeds, push the side rail spacer completely down again and adjust the pendulum until the side rail spacer can no longer be pulled out.

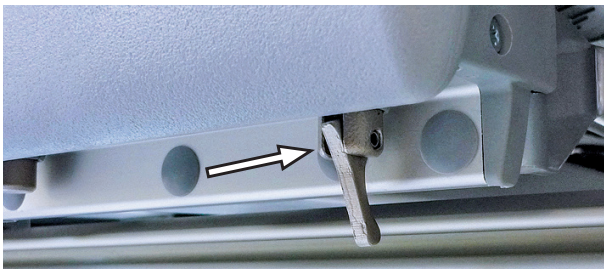

To remove the side rail spacer from the holder, move the pendulum into a vertical position and at the same time pull the side rail spacer upwards and out.

⚠ **NOTE** Please follow the detailed instructions for use of the side rail spacers.

⚠ **WARNING** Make sure that the side rails are fully raised and engaged. When operating the electric lying surface adjustment function or the side rails, ensure that the patient is not in contact with the side rails and that no body parts are protruding through the side rails. Locking the hand control unit functions is strongly recommended.

### Accessory rails on both sides

Accessory rails are available for the bed in two different lengths.

- Length 40 cm
- Length 60 cm



Both rails can be individually attached to the longitudinal profiles on either side of the bed.

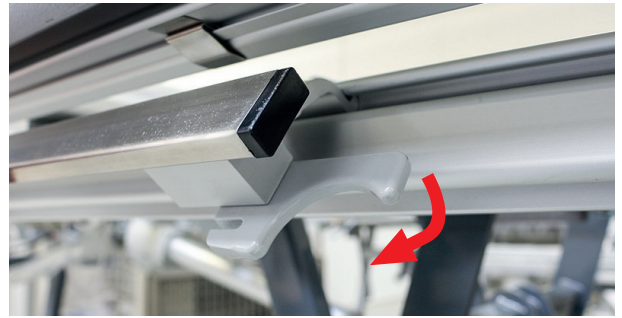

Hook the accessory rail into the side panel. Turn the two clamping levers inwards by 180° to lock the accessory rail in place.

⚠ **WARNING** If the bed needs to be moved or adjusted, the infusion lines and cables must be closely monitored by care staff.

You should also note that drainage devices could touch the floor when the bed is lowered. This also applies to the Trendelenburg and reverse Trendelenburg position.

The safe working load of each accessory rail is 20 kg.

⚠ **NOTE** If the lying surface height is lowered to below 40 cm, any objects attached to the accessory rail must be removed.

### Restraint holders

The bed can be equipped with restraint holders. These can be attached to the side panels.

The restraint holders are mounted on the side panels and have the same type of fasteners as the accessory rails, which also allows them to be attached in variable positions.

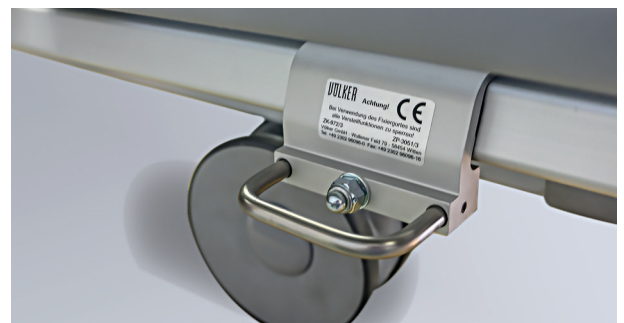

Restraint holder for side panel

### Use of restraint systems

Restraint systems must only be used in accordance with the manufacturer's exact specifications.

⚠ **WARNING** The adjustment functions of the lying surface must be locked when restraint is applied and the hand control unit must be kept out of the patient's reach.



## Functional description | Configurations 1/2

### MiS® lying surfaces

Völker MiS® is a positioning system featuring different elements that maintain and promote the patient's spontaneous movement.



### HPL lying surfaces

The 4-part HPL (high pressure laminate) lying surface is composed of moisture-resistant high-pressure laminate.

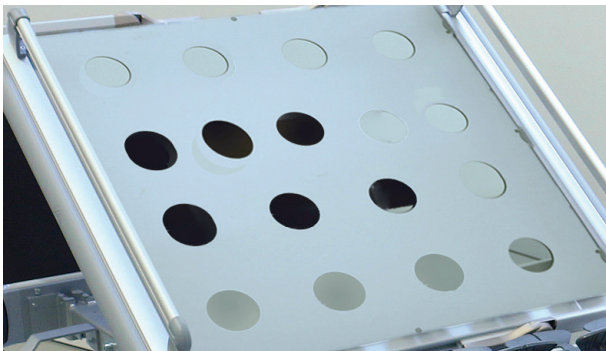

The lying surfaces are easy to remove and can thus be cleaned quickly and thoroughly.

### Castors

The following castors are available:

- Integral S single castors (∅ 125 mm)  
Lying surface height = 31.0 - 86.0 cm
- Integral single castors (∅ 150 mm)  
Lying surface height = 33.5 - 88.5 cm
- Integral S single castors (∅ 150 mm)  
Lying surface height = 33.5 - 88.5 cm
- Linea twin castors (∅ 125 mm )  
Lying surface height = 28.5 - 83.5 cm
- Twin castors (∅ 150 mm)  
Lying surface height = 33.0 - 88.0 cm
- Linea twin castors (∅ 150 mm)  
Lying surface height = 31.0 - 86.0 cm
- Twin castors (∅ 150 mm)  
Lying surface height = 35.0 - 90.0 cm

The safe working load of the bed with all castors remains as specified on the type plate.

### Angle indicator

The angle indicator makes it easy to read the angle of inclination of the back section.

The angle indicator has no clinical use.

### Side rails

The bed can be equipped with the following moving split side rails:

- Height 34–35.5 cm\*
- Height 37–38.5 cm\*
- Height 43.5–45 cm\*

Fixed split side rails are also available:

- Height 41.5–43 cm\*

### Fifth castor

The bed can be equipped with a fifth castor to improve manoeuvrability.



### Bed extension

The bed extension extends the bed lying surface by approx. 28 cm.



The bed extension is recommended for patients taller than 185 cm.

A suitable mattress extension wedge (PMA2215 - 90 cm width) must be used when using the bed extension.

**⚠ WARNING** The bed extension must not be used as a seat! The safe working load is 50 kg.

\* Measurement from the top edge of the side rail to the lying surface (without mattress). The various heights depend on the lying surfaces (MiS® or HPL).

### Under-bed light

The bed can be equipped with an under-bed light to aid orientation in the dark.

The under-bed light is switched on and off using the hand control unit or the keypad.



### Fold-down head or foot section

The fold-down head or foot section provides staff with improved access to the patient if required or in an emergency. It can also be used as a linen holder, for example (only possible for beds 90 cm wide).

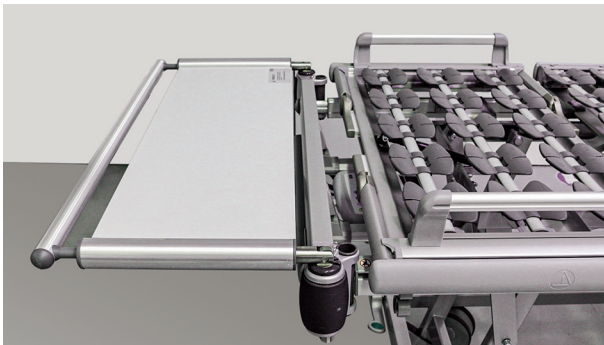

# Putting the bed into service | General operating instructions

## Duty cycle

The maximum continuous duty cycle of the electromotive bed functions is indicated on the bed (type plate).

2 min/18 min means that each electromotive adjustment may be operated for a maximum of 2 minutes, followed by a break of 18 minutes (to protect against overheating).

- ⚠ **NOTE** If the maximum duty cycle of 2 minutes is exceeded repeatedly or for long periods, this may result in failure of the electromechanical drive due to the safety cut-out being triggered. The motor must not be used to adjust the bed until it has cooled down sufficiently.

## Battery

The battery in the bed has a charge capacity which theoretically allows the continuous operation of at least 2 adjustment cycles.

- ⚠ **NOTE** If the bed is parked at its location and the power connector is not plugged in, this will cause the battery to discharge due to buffering of the electronic components.

Deeply discharged batteries may be damaged, making premature replacement necessary.

It is essential to use the battery properly to achieve a long battery life.

Ideally, the bed should be permanently connected to the mains to ensure electrical function at all times.

If the bed is stored for a prolonged period, the battery must be recharged every 3 months, assuming a storage temperature of approx. 25°C. This interval is reduced if the bed is stored at higher temperatures.

## Safety mechanism

The bed is fitted with an electric, automatically reset safety mechanism that prevents drive overload. The bed switches off automatically in the event of a very high level of overload.

## Setup conditions

The bed is approved for operation in dry rooms only (see the section on technical data, p. 51). A power supply is essential in the setup room for operating the bed.

Please note that the mains socket for the bed must be freely accessible and not impeded by a piece of furniture, for example.

## Transportation

The bed can be moved without auxiliary transportation devices. To move the bed, use the nurse keypad to switch it into movement mode (lying surface at a height of at least 40 cm) and release the castor locks.

When transporting the bed, the mains cable must be secured in such a way that it cannot be rolled over, damaged in any other way or cause a tripping hazard. Use the cable hook supplied for this purpose. For information on operating the brakes/direction lock, see p. 44.

- ⚠ **NOTE** The bed must be moved by two people, one at the head end and one at the foot end.

## Control unit wiring

Check that the motor cables are connected to the control unit in the correct order before putting the bed into service or after the motor plugs have been removed. This requires the back section to be fully raised. To open the control unit, use a slotted screwdriver to turn the yellow locking knob anticlockwise and remove the cover.





## Commissioning | Preparation

The standard sockets assignments are shown here:

Socket 1	Socket 2	Socket 3	Socket 4
Lifting motor, head end	Lifting motor, foot end	Motor, back section	Motor, upper leg section



Patient hand control unit

Nurse keypad

Battery

### Commissioning

To put the bed into service, plug the mains plug into a socket. The mains cable is strain-relieved. The bed must be positioned so that the mains plug is easily accessible.



Strain relief for the mains cable on the head panel.

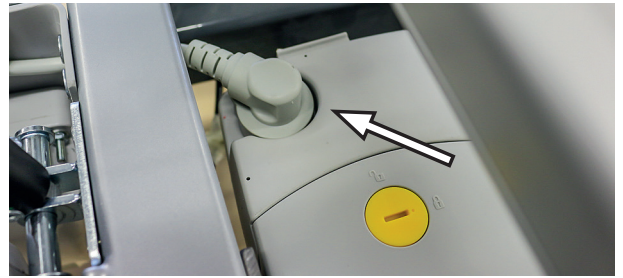

Connection of the power cable to the control unit.

To avoid crushing and damaging the mains cable, it must not be routed sideways across the head end, e.g. in order to reach another socket further away.

**⚠ WARNING** Check the mains cable for damage on a regular basis. If the cable is damaged, the bed must not be used and must be taken out of service immediately.



The equipotential bonding connection is located in the middle of the head bar outside for beds with an external trapeze bar bracket. For beds with 2 internal trapeze bar brackets (one bracket in each inside corner of the head bar), the connection for equipotential bonding is located on the underside of the head bar. The connection is marked by a sticker.

**⚠ WARNING** If electromagnetic interference affects other devices in the area around the bed, please do not operate these devices.

**💡 NOTE** Please note that the plug connections on the control unit and distributor box are only splash-proof when the lid is closed or the socket cover is in place!

# Commissioning | Battery use | Decommissioning

When fully charged, the battery enables the bed to be operated independently of a mains power supply for at least two adjustment cycles.

The battery automatically begins charging when the bed is connected to the mains.

When the bed is put into service for the first time, it must be connected to the mains for approximately 24 hours to fully charge the battery.

The battery must be charged at regular intervals (every 6 months) if the bed is stored for a prolonged period. The minimum charging time is approximately 12 hours.

An audible signal will sound when the battery needs to be recharged. The battery will shut down shortly before deep discharge. After the bed has been connected to the mains, press any button on the hand control unit to make it fully functional again. The battery will charge when the bed is connected to the mains after each use, or if the charge has dropped too far.



The battery is mounted on the inner frame under the back section.

**NOTE** If the bed is not connected to the mains for a long time, the battery may discharge. The extent of the discharge depends on the use of the adjustment functions and on environmental conditions.

## Battery life

The battery should be replaced after three years or earlier depending on the intensity of use. Frequent and rapid discharging will reduce the service life of the battery. The bed must be connected to the mains as often as possible to achieve optimum service life. The battery must be charged at least every 6 months to avoid damage due to self-discharge.

**NOTE** The bed is specified for an ambient temperature of +10°C to +40°C, a relative humidity of 30% to 75% and air pressure of 700 to 1060 hPa.

**WARNING** The battery must only be replaced by staff trained by Völker GmbH.

**WARNING** A faulty battery may result in degassing. In rare cases, this may cause the battery casing to deform. If this occurs, the bed must be taken out of service immediately and moved into a sufficiently ventilated area with no sources of sparks (away from electricity or fire). In such cases please inform Customer Service immediately!

**NOTE** The battery must be disposed of in the appropriate facilities in an environmentally friendly manner. Alternatively, you are welcome to return it to Völker GmbH.

## Decommissioning

Disconnect the bed from the mains before conducting any repair work. Disconnect the battery from the control unit if the bed is taken out of service for an extended period. To do this, use a slot screwdriver to open the control unit and remove the relevant plug from the socket.

**NOTE** Please note that improper handling may result in the battery failing to charge. Improper handling includes, among other things, removing the plug from the socket by pulling on the mains cable, trapping the mains cable between the lying surface and the lying surface frame or running over the cable when moving the bed.

## Commissioning | Functional checks

### Visual inspection

Before a new occupant is accommodated in the bed, check that:

- There is no external damage to the bed.
- Electric cable insulation is satisfactory.
- The next inspection date has not been missed (see inspection label on the type plate).
- Check the mains cable for damage at regular intervals.

### Functional tests

Before a new occupant is accommodated in the bed, conduct the following functional tests:

- Actuate all electrical functions fully to their end positions one time each.
- Check that the bed brakes are working.

If the functional checks do not reveal any faults, the bed is ready for use.



**WARNING** Only undamaged beds that have not yet reached the end of their test interval may be used.

## Operation | Side rails | General safety instructions



**WARNING** All persons responsible for handling the side rails must read and follow the information below.

- When adjusting the back, upper leg or lower leg sections or operating the lifts or the side rails, it is essential to ensure both that the patient does not come into contact with the side rails and that no body parts are protruding through the side rails.
  - If the side rails must be used due to the patient's mental condition, it is important to ensure that the hand control unit is kept out of their reach or that all its functions are locked. The hand control units can also be removed.
  - Protective covers are available as an accessory for the side rails. These offer additional protection against injuries caused by contact with the side rails. Use of these protective covers is recommended for all persons with a very high risk of injury due to unavoidable contact with the side rails. Carers and patients must still take due care when operating the bed even when the covers are in use.
  - All types of side rails must always be either completely raised and securely engaged, or completely lowered to the stop. The side rails must never be left in an incompletely engaged position as they then pose a trapping hazard.
- If the side rails are damaged, the patient is in danger of falling out.
  - The legal admissibility of using the side rails must be ensured.
  - The side rails must only be operated by trained care staff.
  - Ensure that no body parts are protruding through the side rails when the electrical lying surface adjustment function is activated.
  - Ensure that the side rails (or parts thereof) are either fully raised and locked or fully lowered.



**DANGER** Failure on the part of care staff to observe the above safety measures may result in injury.

All types of Völker side rails can only be replaced with tools. Only Völker GmbH approved side rails may be used for the bed.



## Operation | Moving split side rails

### A. Raising the side rails

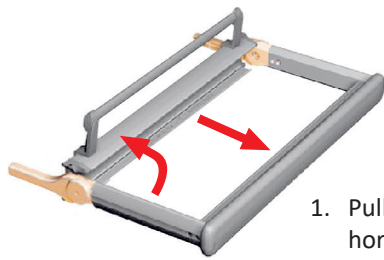

1. Pull out the side rail horizontally as far as it will go and then fold it upwards. Then hold the handrail and pull the side rail up to its full height.

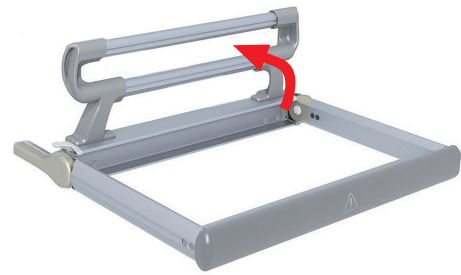

When using the elevated side rails (43.5–45 cm), the mattress holders must be folded out before raising the rails and folded in again after the rails have been retracted.

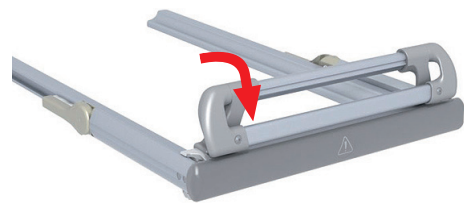

### B. Lowering the side rails

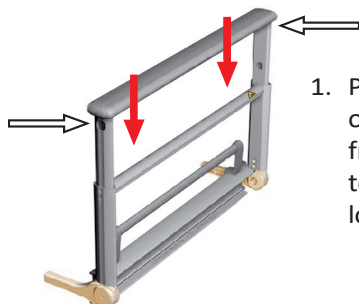

1. Push the two buttons on the outside of the frame to move the telescopic part to its lowest position.

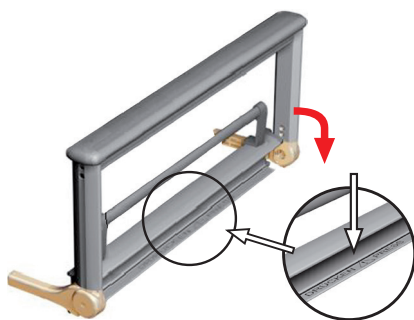

2. Push the button labelled "Drücken/Press" at the bottom of the side rail. Then tilt the rail until it is horizontal and parallel with the floor.

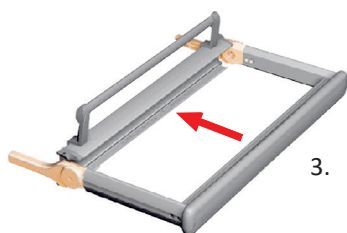

3. Slide in the side rail until it is fully retracted under the lying surface.

Ensure that side rails measuring 37–38.5 cm and 43.5–45 cm are only used in conjunction with clamps at the head and foot ends. The head and foot ends must be positioned so that the clamps are facing the inside of the bed. The warning label indicates the risk of crushing at this point.

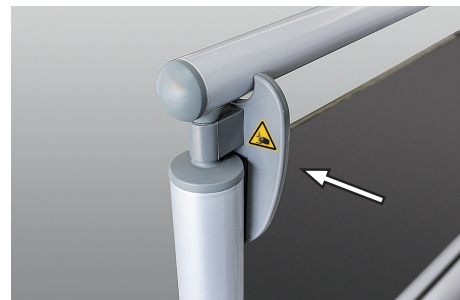

! **NOTE** The side rails must always be handled and moved up or down by placing two hands at the ends of the respective element.

! **NOTE** The stability of the side rails means that they can also be used as a shelf for bedding (maximum 15 kg) or as a support surface for care-related bed positions, such as Bobath positions, or when carrying out physiotherapy treatments.

## Operation | Fixed split side rails

### A. Raising the side rail

1. With one hand on either end of the handrail, pull the side rail upwards until it locks into place in the middle position.



2. Then pull the handrail all the way up until it engages to extend the side rail to its full height.



### B. Lowering the side rail

1. To lower the side rail, hold the handrail by the end caps and raise it slightly to release the upper catches. At the same time, push the two front locking knobs in and slide the upper section back down into the middle position.



2. To lower the side rail further, raise the side rail slightly using the longitudinal profiles to release the lower catch. At the same time, push the two outer locking knobs in and slide the middle section down into the lowest position.



**WARNING** Fixed split side rails must be extended to their full height in order to ensure the required minimum height of 220 mm above the upper edge of the mattress.

If the side rail is only extended as far as the middle position, the side rail is **not** performing its protective function!

**NOTE** The side rails must always be handled and moved up or down by placing two hands at the ends of the respective element.

## Operation | Hand control unit | Adjusting the back section

The back section of the lying surface can be raised to a maximum angle of 71°.

The back and upper leg sections can be adjusted at the same time by pressing both switches simultaneously:

- Back section up + upper leg section up  
or
- Back section down + upper leg section down

If one of the two buttons is released during the adjustment process, the other sections of lying surface will continue to move.



Back section up

**⚠ WARNING** When raising the back section with the side rails up, ensure that none of the patient's body parts or the body parts of other persons are protruding through or resting on the side rails.

**💡 NOTE** Allowing the patient to adjust certain bed functions using the hand control unit is the responsibility of care staff.

For reasons of safety, it is advisable to use the nurse keyboards locking function if the patient is left unsupervised, or if the patient is confused or weak.

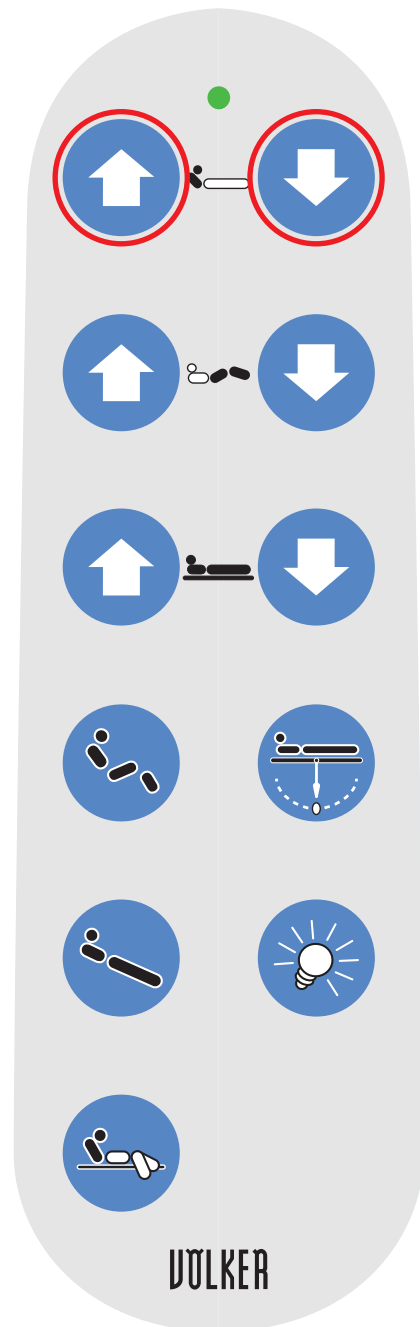

## Operation | Hand control unit | Adjusting the upper leg section

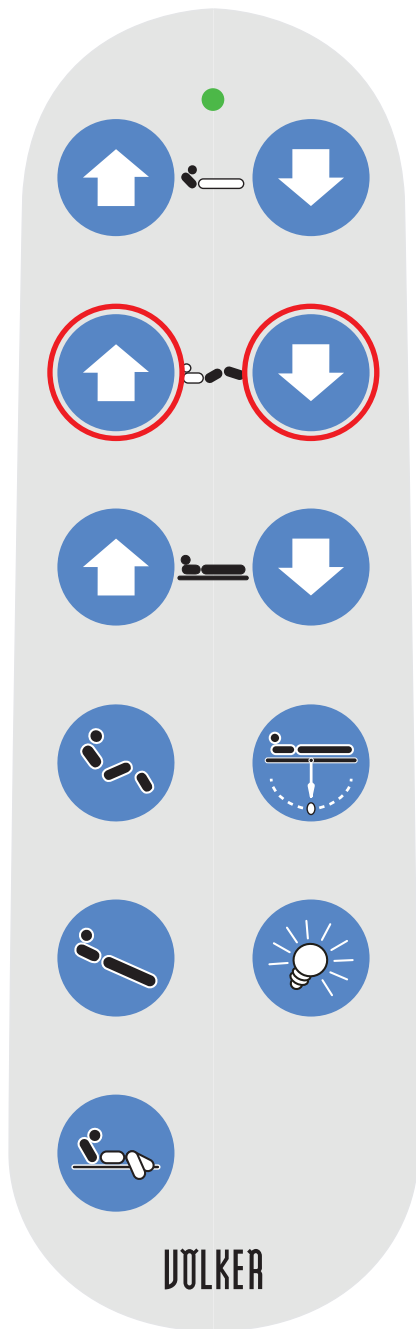

The upper leg section can be raised to a maximum angle of 37°.

**⚠ WARNING** When raising the upper or lower leg section with the side rails up, ensure that none of the patient's body parts or the body parts of other persons are protruding through or resting on the raised side rails.

**⚠ WARNING** The area between the raised side rails and the foot end is a trapping hazard when the upper leg section is being adjusted.



Upper leg section up



## Operation | Hand control unit | Adjusting the lower leg section (manually)

The lower leg section can be moved manually to any height by pulling the mattress holder (when moving split side rails are fitted).

If the bed is fitted with fixed split side rails, pull the back end of the lower leg section.

To lower the lower leg section, push it down again.



Lower leg section up

## Operation | Hand control unit | Adjusting lying surface height

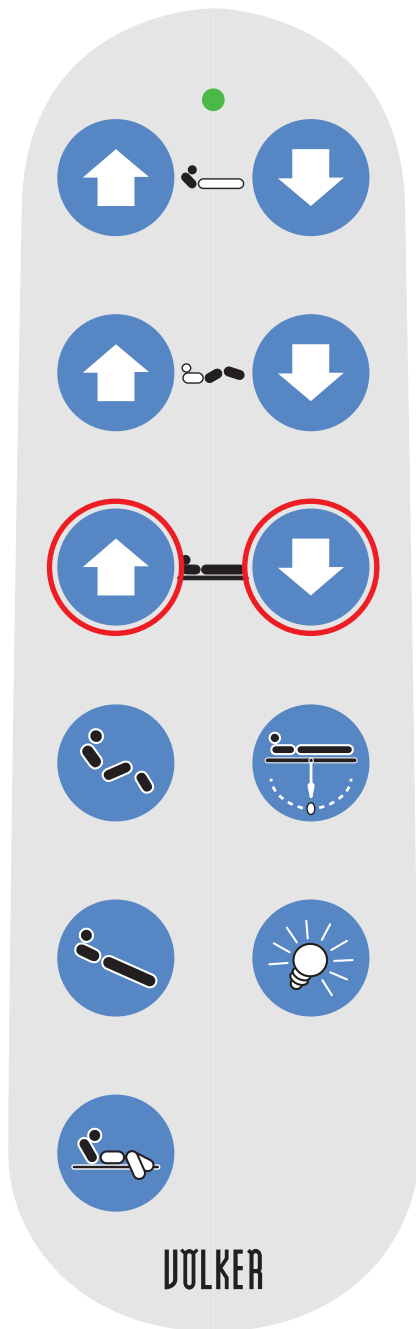

The lying surface height can be adjusted between approx. 28.5 cm and approx. 90 cm (depending on configuration).

The lying surface can only be lowered to a height of approx. 40 cm using the hand control unit (depending on the choice of castors).

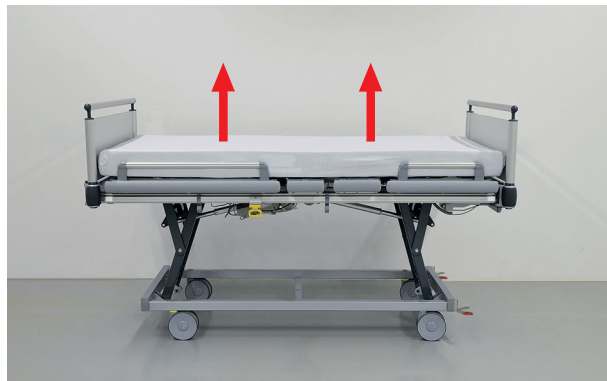

Lying surface raised

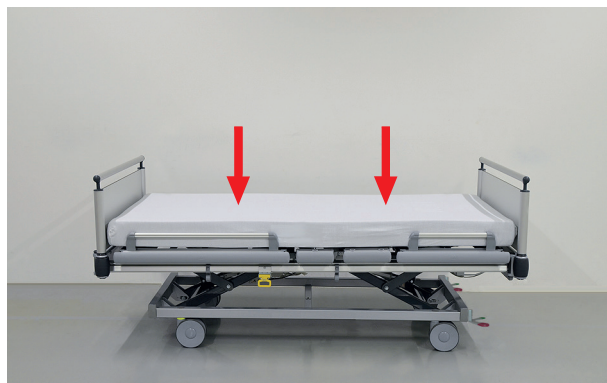

Lying surface lowered

- NOTE If the height of the bed can no longer be adjusted, the block can be released by pressing the key combination "lying surface up/down". To do this, both keys must be pressed simultaneously for approx. 10 seconds until the LED at the top flash. A blockage of the back section and thigh section motor can also be released in this way.

## Operation | Hand control unit | Setting the comfort seating position

The comfort seating position allows the patient to assume their preferred seating position.

To set the seating position, press the relevant button until the desired position has been reached.



Comfort seating position

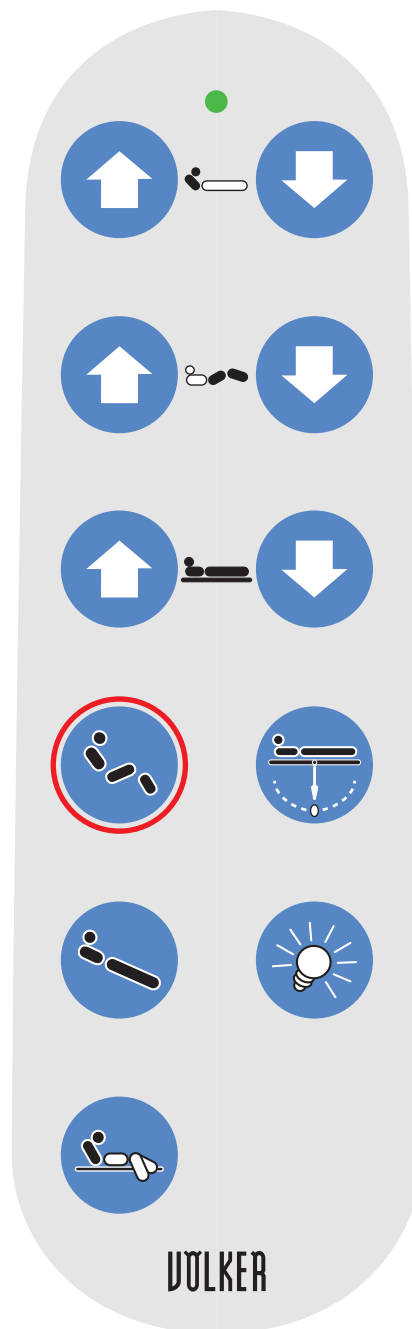

## Operation | Hand control unit | Setting the reverse Trendelenburg position<sup>1</sup>

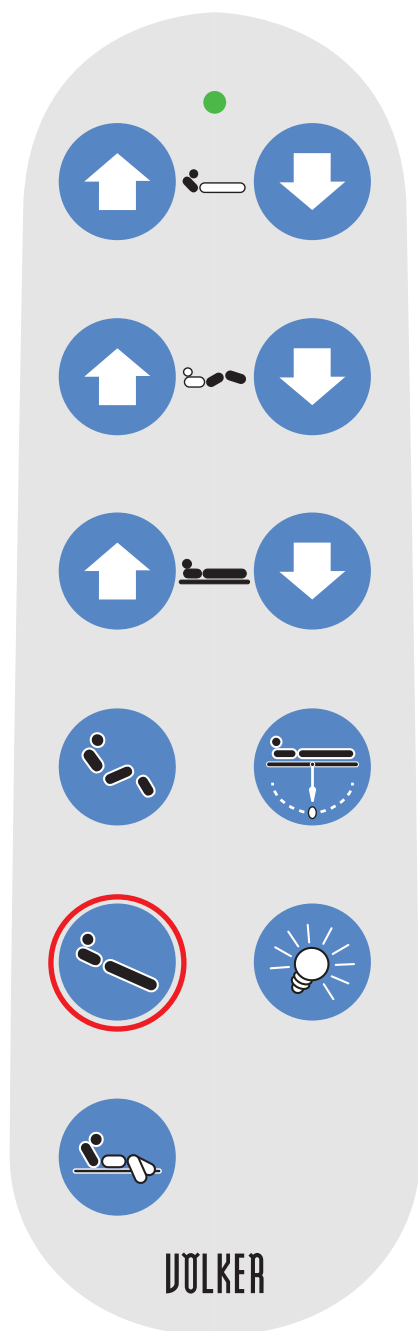

The reverse Trendelenburg position can be adjusted to a maximum angle of 14°.

To set the reverse Trendelenburg position, press the relevant key until the desired position has been reached.

Ensure that any drainage lines attached to the bed do not touch the floor.



Reverse Trendelenburg position<sup>1</sup>

<sup>1</sup> Head end raised

## Operation | Hand control unit | Setting the egress aid

 **WARNING** Ensure that the castors are braked before the patient gets into or out of the bed.

The "Egress aid" function moves the bed into a position that allows the patient to leave the bed safely and easily at the push of a button.

Please note that the egress height depends on the castors used.



Egress aid

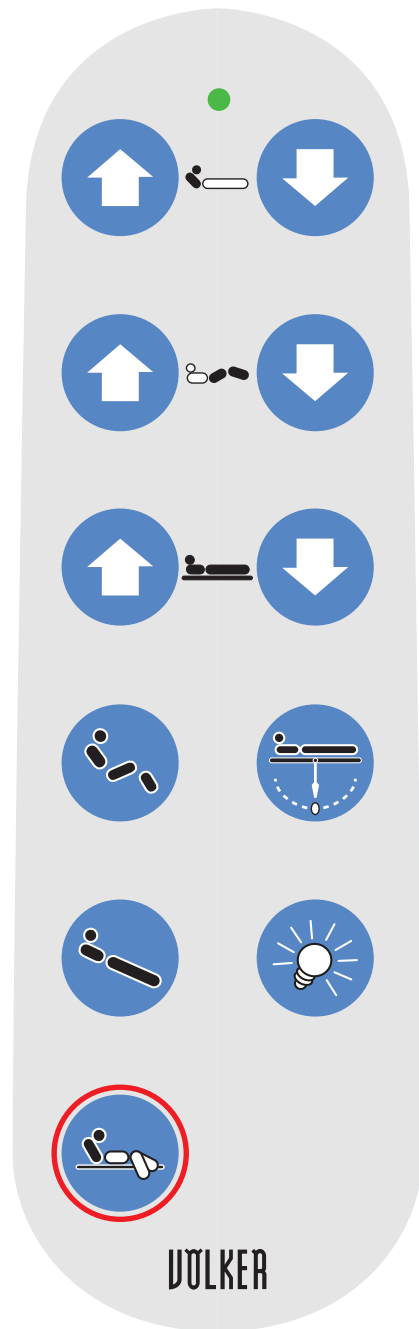

## Operation | Hand control unit | Setting a horizontal lying surface position

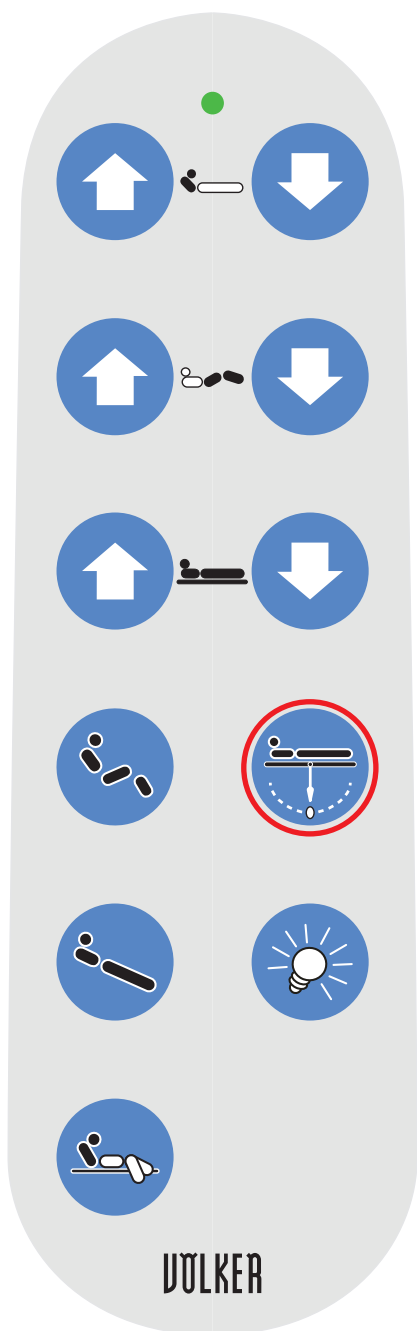

Pressing the "Lying surface flat and horizontal" button moves the lying surface into a horizontal position and lowers the back and upper leg sections.



## Operation | Hand control unit | Under-bed light

The "Under-bed light" button switches the light located under the bed (depending on the configuration) on and off.

The under-bed light is mounted underneath the fixed seat.

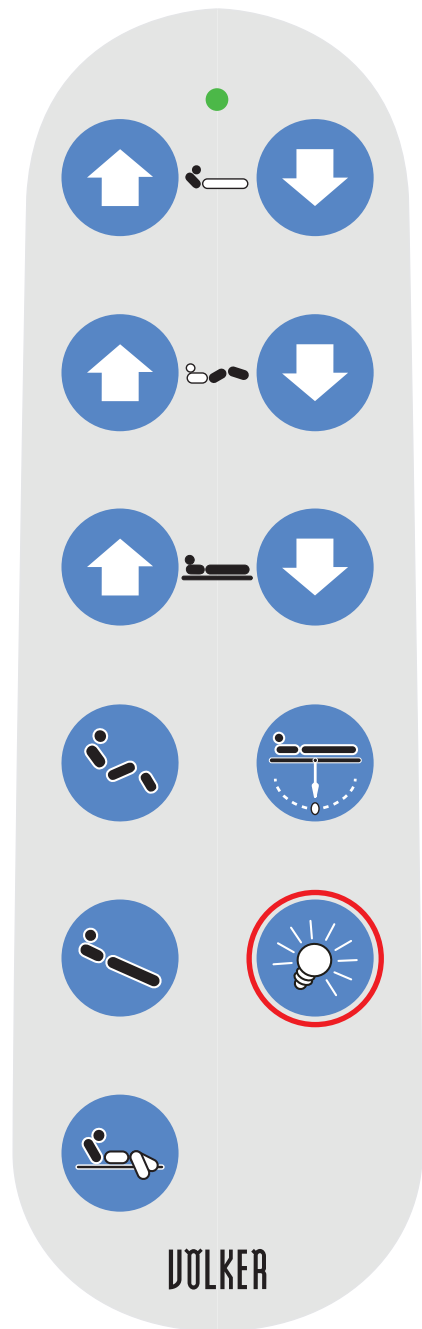

## Operation | Nurse keypad | Adjusting the back section

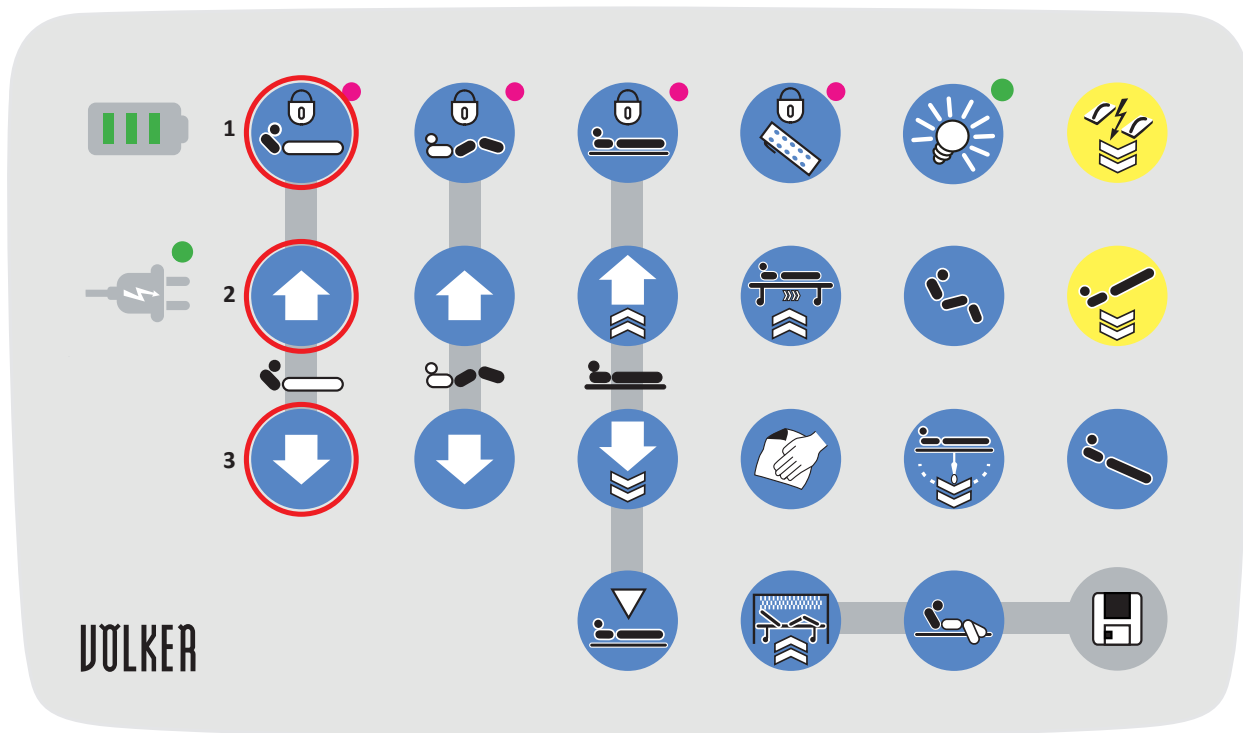

**⚠ WARNING** Only care staff may operate the nurse keypad.

- 1 The back section adjustment functions can be locked using the lock button at the top. This also locks the hand control unit. The LED is lit continuously to indicate locking. The "Comfort seating position" and "Egress aid" functions are also disabled at the same time.
- 2, 3 The back section can be raised to a maximum angle of 71°.



## Operation | Nurse keypad | Adjusting the upper leg section

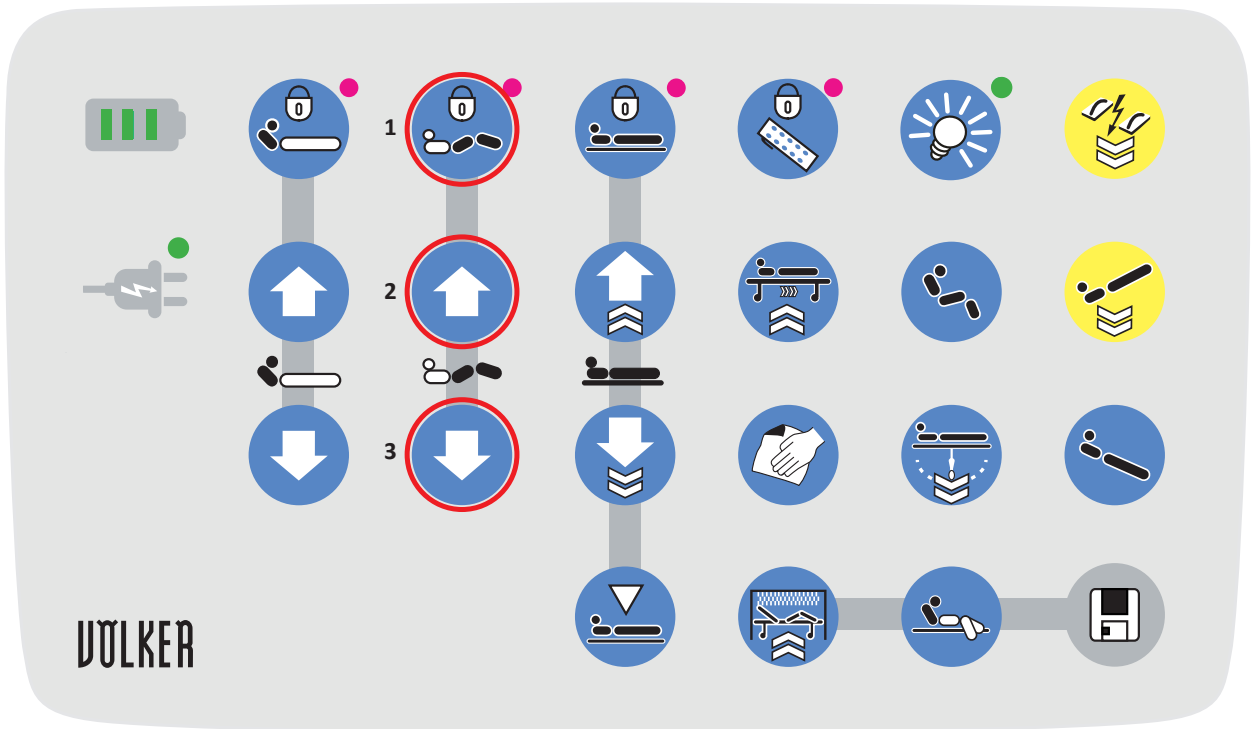

**⚠ WARNING** When raising the upper or lower leg section with the side rails up, ensure that none of the patient's body parts or the body parts of other persons are protruding through or resting on the raised side rails.

**⚠ WARNING** The area between the raised side rails and the foot end is a trapping hazard when the upper leg section is being adjusted.

- 1** The upper leg section adjustment functions can be locked using the lock button at the top. This also locks the hand control unit. The LED is lit continuously to indicate locking. The "Comfort seating position" and "Egress aid" functions will also be disabled at the same time.
- 2, 3** The upper leg section can be raised to a maximum angle of 37°.

## Operation | Nurse keypad | Adjusting lying surface height

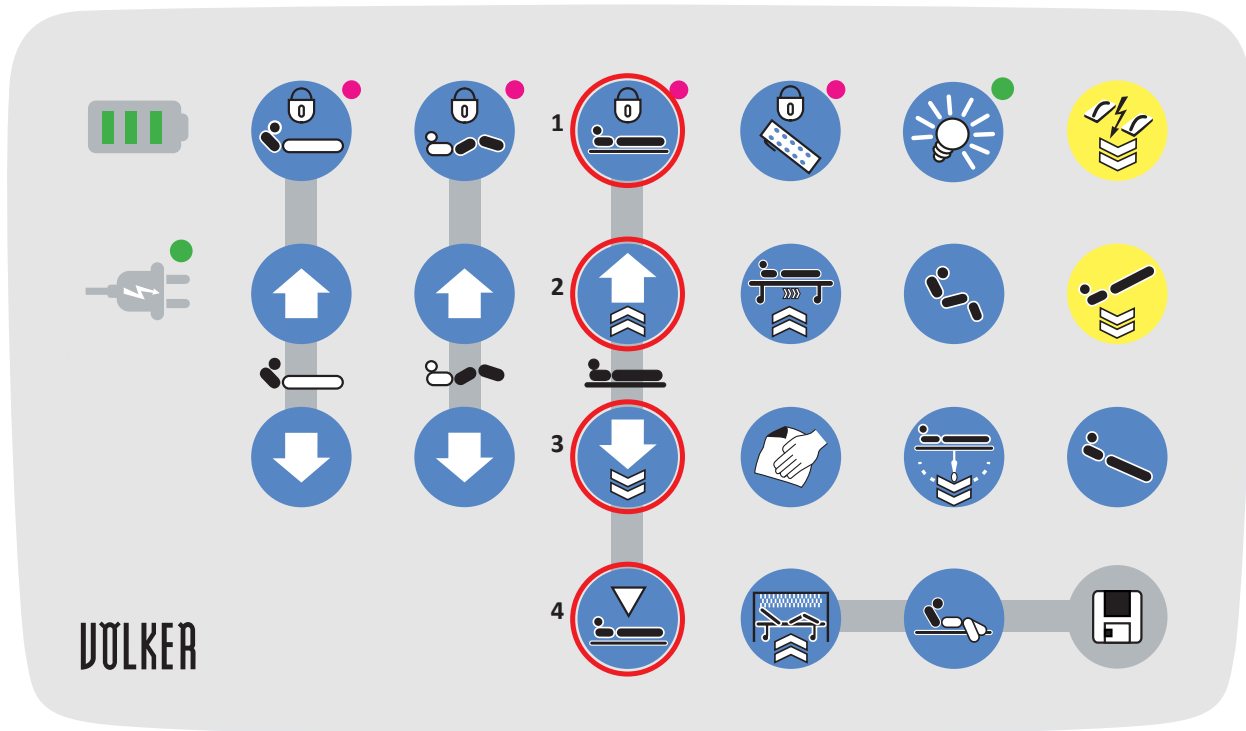

**1** The lying surface height adjustment functions can be locked using the lock button. This also locks the hand control unit. The LED is lit continuously to indicate locking. The "Comfort seating position" and "Egress aid" functions will also be locked at the same time.

**2, 3** The lying surface height can be adjusted (depending on the configuration) to between approx. 28.5 cm and approx. 90 cm.

These heights can be set automatically by pressing the button twice (depending on country).

**4** A lying surface height of below 40 cm can only be set by staff. To do so, simply press and hold the lowest of the three lying surface adjustment buttons ④ until the required height is reached.

Please note that the height of the lying surface depends on the castors used.

**NOTE** Always check the area immediately surrounding the bed when setting the lowest position. Ensure that there are no persons, limbs, pets, bedding or other objects in the space under the bed.

**NOTE** If the height of the bed can no longer be adjusted, the block can be released by pressing the key combination "lying surface up/down". To do this, both keys must be pressed simultaneously for approx. 10 seconds until the LEDs at the top flash. A blockage of the back section and thigh section motor can also be released in this way.

**NOTE** When the lying surface height is approached using the double-click function, a warning signal sounds, which indicates that the bed is in automatic operation.

## Operation | Nurse keypad | Hand control unit lock, transport position, cleaning position, washing system position

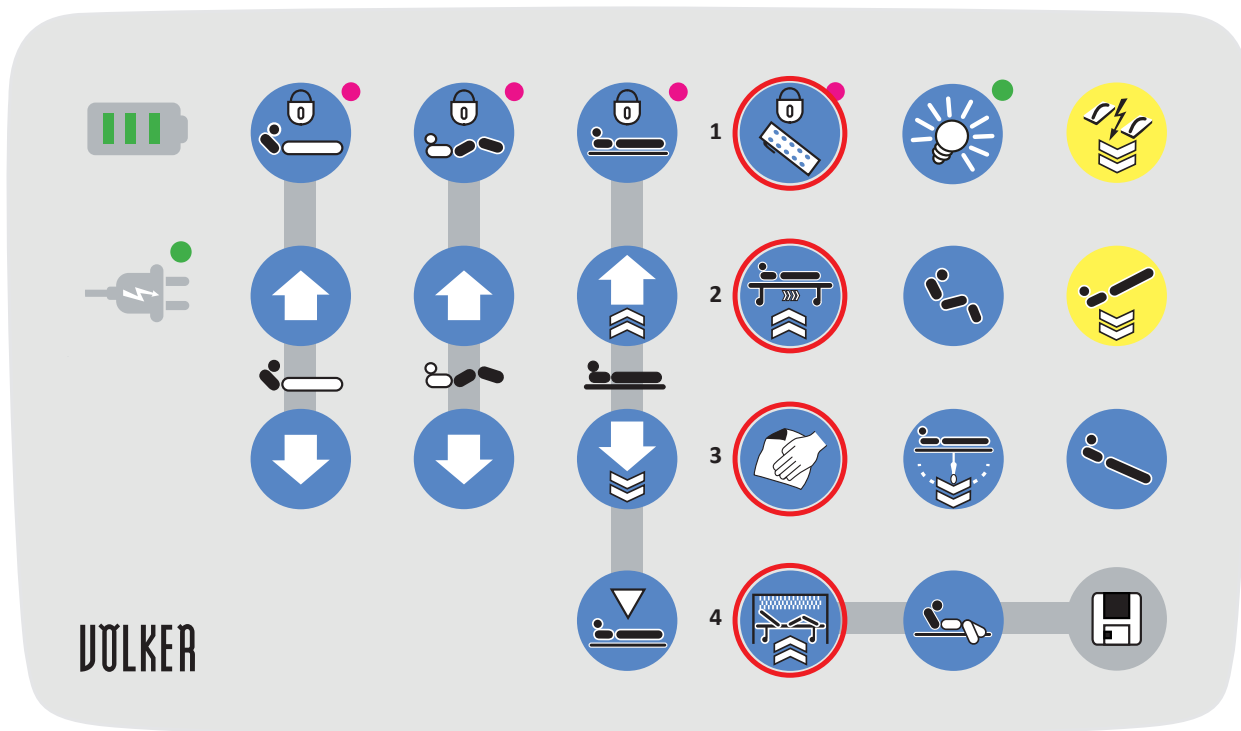

- 1 Pressing the hand control unit lock button blocks all use of the hand control units connected to the bed.
  - 2 Pressing the transport position button twice (depending on country) moves the bed into the transport position.
  - 3 Pressing the cleaning position button moves the bed into a position that allows the bed to be cleaned easily by hand.
  - 4 Pressing the washing system position button twice sets a predefined washing position that can, however, be adapted individually to suit the particular system using the adjustment buttons.
- NOTE** Please refer to the information on the type plate to ascertain whether your bed is suitable for a washing system.

## Operation | Nurse keypad | Under-bed light, comfort seating position, lying surface flat and horizontal, egress aid

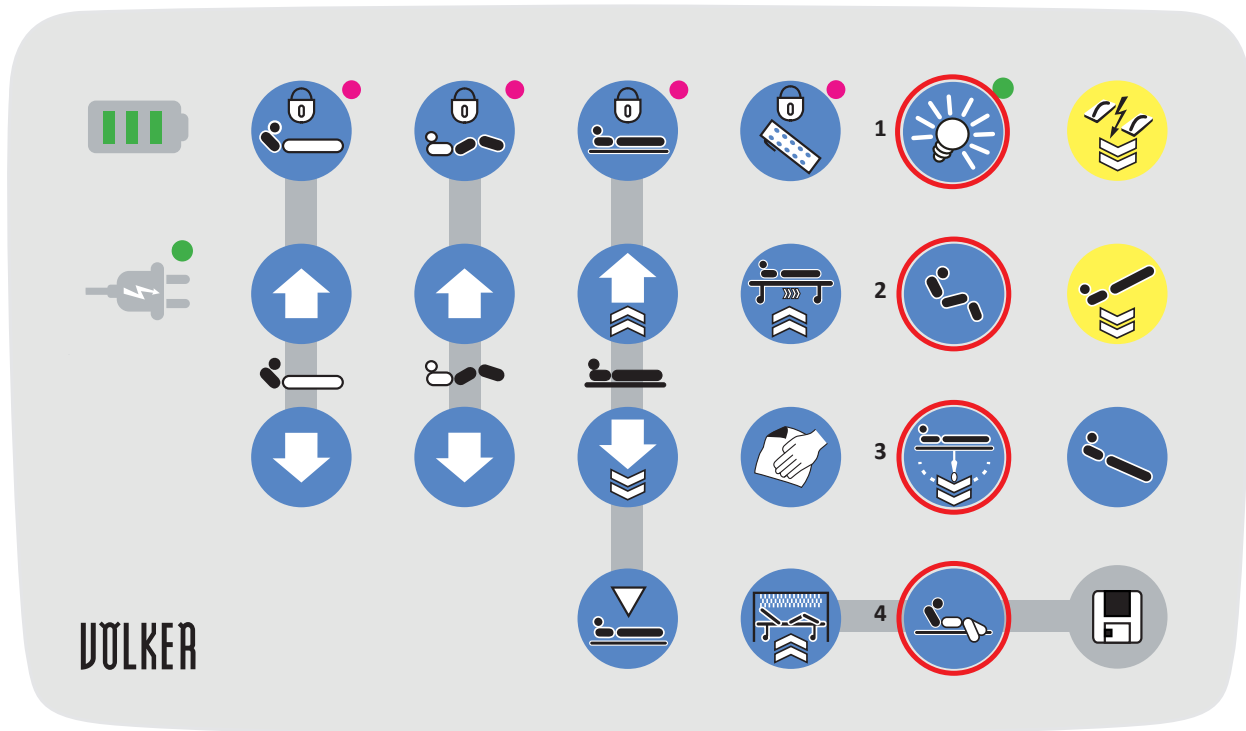

- 1 The under-bed light (depending on configuration) can be switched on and off via the nurse keypad. If the under-bed light is switched on, the corresponding LED lights up if the bed is connected to the mains power supply.
- 2 The comfort seating position can be set at the touch of a button. To set this position, press and hold the relevant button until the desired position has been reached.
- 3 Pressing the lying surface flat and horizontal button twice (depending on country) adjusts the lying surface so that it is flat and moves the back and upper leg sections into the lowest position.
- 4 The egress aid function moves the bed into a position that allows the patient to leave the bed safely and easily at the push of a button. Please note that the egress height depends on the castors used.

## Operation | Nurse keypad | Resuscitation position, Trendelenburg position<sup>1</sup> and reverse Trendelenburg position<sup>2</sup>

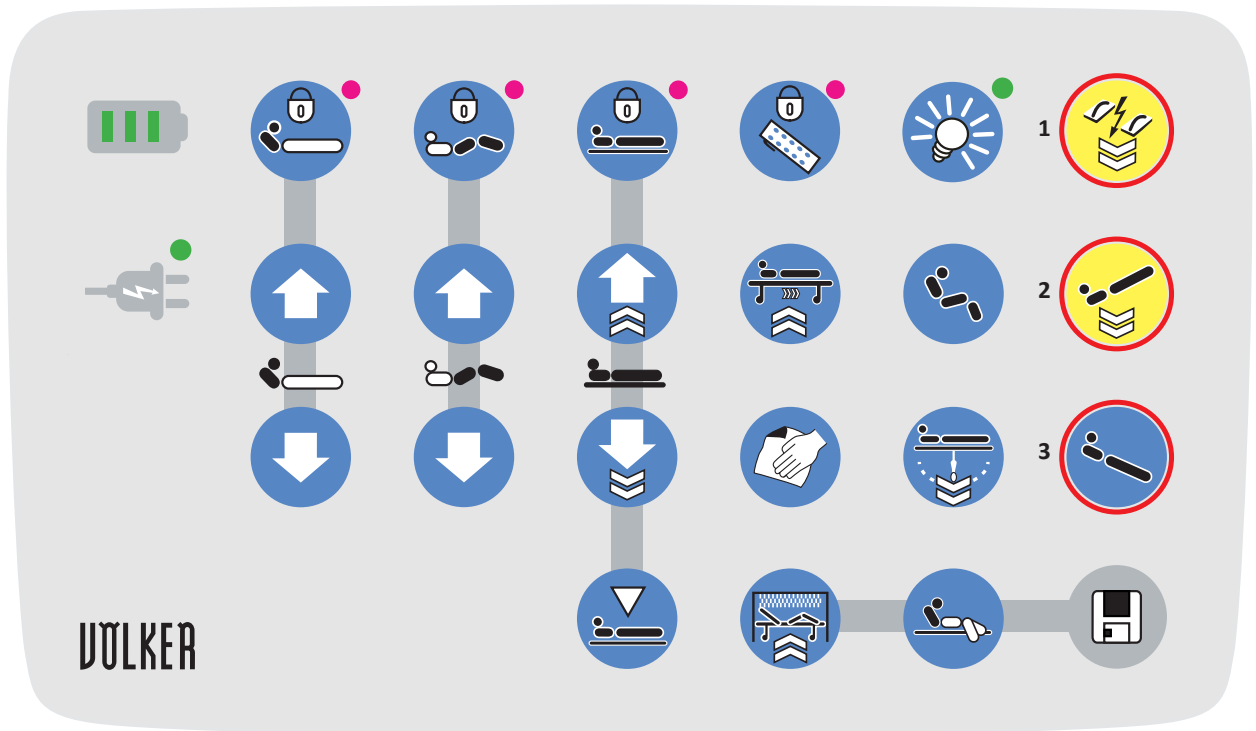

- 1 Pressing the resuscitation position button twice (depending on country) adjusts all sections of the lying surface so that they are in a horizontal position and moves the bed to a predefined height. Please note that the height of the lying surface depends on the castors used.
- 2, 3 The nurse keypad can be used to set both the Trendelenburg position (2) and the reverse Trendelenburg position (3). Set the Trendelenburg position by pressing the button twice.

 **WARNING** This position must only be used with clinical approval and by trained care staff as use of the Trendelenburg position depends on clinical indications.

<sup>1</sup> Head end lowered

<sup>2</sup> Head end raised

## Operation | Nurse keypad | Memory functions

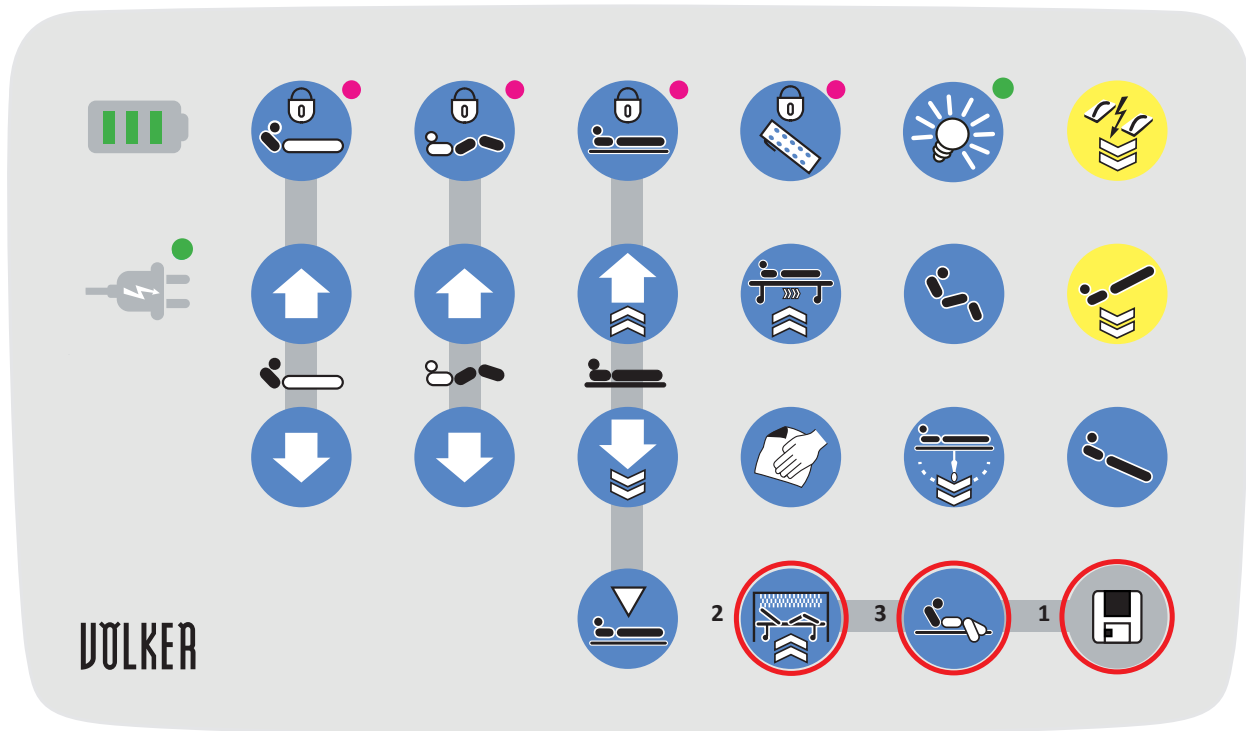



1 The Memory function is used to save the respective lying surface heights for the washing system position or for the egress aid.

To save to the memory, briefly press the "Save" button (1) once, and then press either the "Washing system position" button (2) or the "Egress aid" button (3) until a beep confirms that the position has been saved successfully.

## Operation | Rapid lowering of the back section/CPR function

The bed is equipped as standard with a mechanical function that rapidly lowers the back section for the purposes of resuscitation (CPR).

-  **WARNING** The CPR function (cardiopulmonary resuscitation function) must only be used in **emergencies** and by trained, qualified staff!
-  **WARNING** The CPR function must **not** be used instead of the hand control unit to lower the back section!
-  **WARNING** It is essential to hold the back section firmly by the mattress holder to avoid sudden lowering with the patient!



Handle under the seat section on either side for quickly lowering the back section for resuscitation.



Pull the yellow handle forward to lower the back section rapidly. The back section will lower rapidly.

The backrest motor will be activated automatically when the CPR handle is released.

Improper use of the CPR function may cause damage to the bed and/or the motor that controls the back section!

## Operation | Bed extension

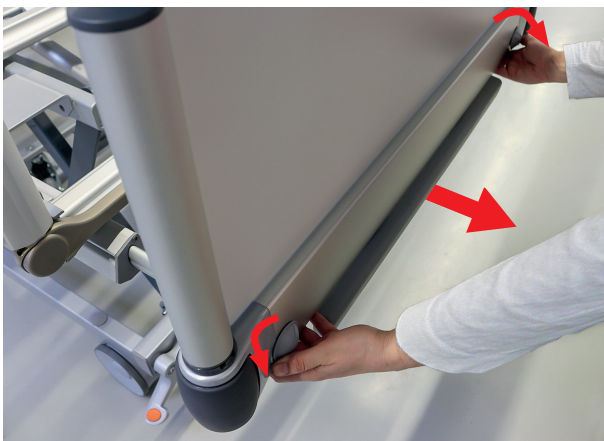

To pull out the bed extension, twist the two locking knobs downwards at the same time and pull the bed extension outwards until it engages.

To push it back in, twist the two locking knobs downwards again and push the bed extension in until it engages.

The bed extension must also be engaged when retracted.

-  **WARNING** The bed extension must not be used as a seat! The safe working load is 50 kg.



When using the bed extension, a suitable mattress extension wedge must be used.



## Operation | Castors

### Securing the brakes

All the bed castors are braked when the brake lever with the red rubber pedal is depressed.

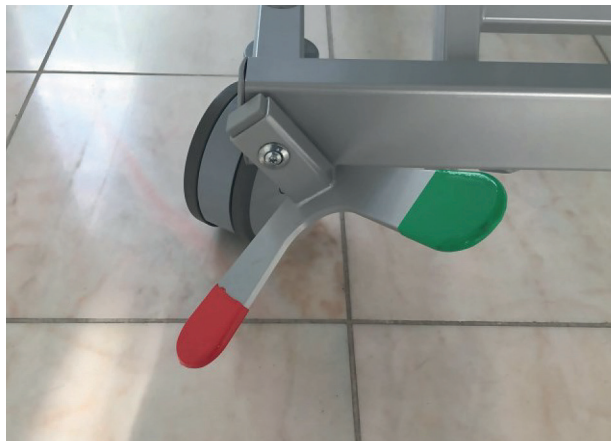

### Releasing the brakes

Move the brake lever into the horizontal position to override the locking of all castors. The bed can be moved freely and rotated on the spot.



### Locking the direction lock

Press down the green rubber pedal to lock the direction lock. This simplifies moving in a straight line when transporting the bed.

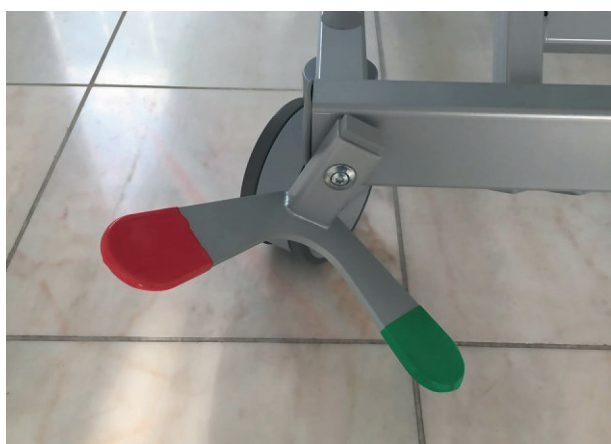



# Cleaning and disinfection

To maintain the bed's functionality, it must be cleaned, disinfected and tested

- At regular intervals
- As required
- After every change of occupant
- In accordance with the guidelines of the relevant hygiene schedule

so that it can be used again immediately and without risk. Hazards may arise due to improper cleaning/disinfection of the bed. The degree of disinfection must be determined by the user!

As a general rule, only use disinfectants that are in line with current technological standards.

The current healthcare standard can be found, for example, in the VAH List [from the German Association of Applied Hygiene], RKI [Robert Koch Institute] guidelines or also in the IHO List [from the German Industrial Association for Hygiene and Surface Protection]. Unless any specific ingredients that must NOT be used are given in the respective instructions for use, the disinfectants listed there may be used.

All disinfectants must be used according to the disinfectant manufacturer's instructions.

Due to the large number of available products, Völker GmbH cannot approve specific products and list them in the instructions for use.

Please observe the information provided by the cleaning product manufacturer.

Not following these instructions can lead to personal injury and material damage.



**WARNING** The bed must always be disconnected from the power supply before being cleaned and disinfected.

## Cleaning

Depending on the degree of soiling, we recommend cleaning the bed with a damp cloth or similar. A soft brush can also be used for stubborn dirt or stains. Do not moisten the bed too much when cleaning.

## Disinfection by wiping

Use cleaning agents in the dilution ratio recommended in the relevant instructions for use issued by the cleaning product manufacturers.



**NOTE** Use of solvents is not permitted.

- Abrasives, scouring pads or other scouring agents must **not** be used.
- Use of chlorine, formaldehyde, phenol-based products and other solvents (toluene, xylene or acetone) is **not** permitted.

The following information regarding cleaning products and disinfectants must be observed:

- The solutions being used must generally be freshly

prepared.

- The concentrations used should be neither higher nor lower than specified. Approximate concentrations must not be used under any circumstances. Under no circumstances must users add cleaning products such as soap or surfactants at their own discretion (inactivation by contact with soap).
  - There is a risk of explosion and fire when spray disinfectants containing alcohol are used over large areas.
  - Cleaning products must not contain corrosive or caustic ingredients.
  - They must not contain any substances that will change the surface structure or the gripping properties of materials.
  - Lubricants must not be affected.
  - The pH of the water must be no higher or lower than 5–8.
  - Water must not exceed a total water hardness of 0.5 mmol/l (corresponding to 5°dH).
- The information provided by us does not exempt users from conducting their own investigations and tests as local conditions (e.g. water hardness) can vary. No legally binding assurance of certain properties can be deduced from this information.
- Cable plugs and the sockets of the control unit, distributor box and battery are only protected against splashes when connected and when protected by the covers and blind plugs provided.
- Prevent the ingress of water and cleaning agents into unused connections.
  - Labels and markings must not be cleaned with a brush or using high pressure.
  - Dry the bed with special care and test it before reuse.
  - Stubborn dirt or stains must be soaked before cleaning (please test first).

## Spray lances and washing systems\*



**WARNING** Cleaning and disinfection with spray lances of high-pressure cleaning equipment is **not** permitted.

Völker GmbH accepts no liability for damage sustained to the surface coating through the use of unsuitable detergents and disinfectants, incorrect mixing ratios or insufficient care of the beds.

## Cleaning the hand control units/keypads

The hand control units and keypads must be cleaned daily to avoid cross-contamination between the patient and care staff.

---

\* Please refer to the information on the type plate to ascertain whether your bed is suitable for a washing system.

# Maintenance | Staff qualifications, safety instructions | Maintenance schedule

## Staff qualifications

Every person assigned with maintenance and service provision tasks must at least have read the safety regulations for the relevant bed model and be qualified in accordance with the relevant national regulations.

The instructions for use for the bed must always be accessible to service staff to guarantee smooth operation of the bed.

## Safety instructions

The bed requires very little maintenance. All moving parts of the height adjuster, lying surface drives and side rails are provided with permanent lubrication at the factory. It is recommended that **the bed is subjected to regular technical inspections, at least once per year, according to the checklist** (p. 57). Any damage discovered, such as

wear and tear, loose screws or breaks, must be repaired at once.

The following requirements must be strictly complied with during maintenance and technical checks:

- The electrical installation of the room must meet the requirements of current technological standards and the bed must be used as intended.
- The beds are not explosion-protected and must only be serviced in an environment that is free from combustible materials.

 **WARNING** Always disconnect the mains plug before conducting repair work.

 **WARNING** Maintenance and repair work must only be conducted after the bed has been disinfected.

Time period	Work to be conducted
Annually	Technical inspection (p. 47)
After long periods of non-use/ before each new occupancy	Visual and functional inspection (p. 23)
As required	Lubrication of mechanical parts Replacement of battery in the event of faults and at the end of service life (3 years) Replacement of wear parts in the event of faults, e.g. <ul style="list-style-type: none"> <li>• Wings on MiS® lying surface</li> <li>• Spring elements on MiS® lying surface</li> </ul>

## 1. Visual inspection

Check the frame parts for plastic deformation and/or wear. This includes the undercarriage, hoist, all elements of the lying surface (back, seat, upper and lower leg sections, wings and spring elements), trapeze bar, trapeze bar holder and castors.

## 2. Side rails function inspection

The side rails must be inspected for trapping and pinching points in accordance with DIN EN 60601-2-52.

Check that the side rail lock functions properly and whether any deformation or wear is visible on the side rails.

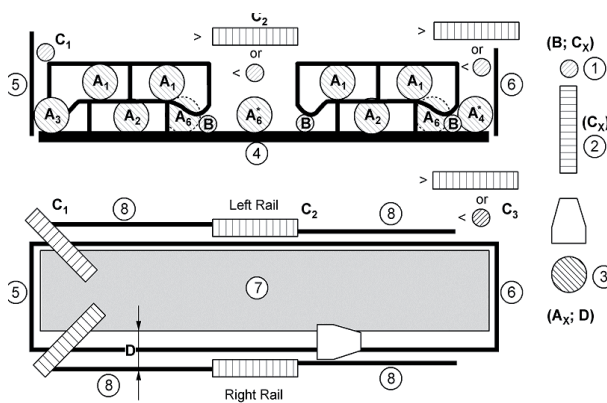

Letter	Description	Dimension
A <sub>x</sub>	Distance between elements within the scope of the SIDE RAILS in a raised/engaged position or in the area formed by the SIDE RAILS and fixed parts of the BED or ACCESSORIES.	In accordance with the applicable standard
B	Not applicable	-
C <sub>1</sub>	Distance between HEAD END and SIDE RAILS	In accordance with the applicable standard
C <sub>2,3</sub>	Distance between split SIDE RAILS and distance between SIDE RAILS and FOOT END	In accordance with the applicable standard
D	Area between SIDE RAILS and MATTRESS	120 mm cone must sink no further than 60 mm below the mattress surface without pressure.
G	Height of the top edges of the SIDE RAILS above the mattress without compression over at least 1/2 of the length of the LYING SURFACE	≥ 220 mm

## 3. Brake function inspection

Check the functionality of the brake.

## 4. Drive function inspection

Run through the complete adjustment range for each individual motor. Pay attention to unusual noises, speed, smooth running etc., and check that the selected function moves in the right direction. In particular, ensure that the motor shuts down automatically when it reaches the end position.

## 5. Mains cable

Check the following for damage:

- Mains cable, including cable ducts
- Strain relief, including anti-kink sleeve
- Mains connector

## 6. Wiring

Check cable routing and check that the plug contacts are properly seated and undamaged. Check cables for damage.

## 7. Casing

Check all casings for damage. All screws must be tight and seals must have no visible signs of damage.

## 8. Mechanical inspection

Check that the Hydrolift is in working order by manually raising and lowering the lower leg section. Also check the CPR function to ensure that it is functioning correctly.

## 9. Handle

Check whether the plastic and strap hangers on the trapeze bar handle show any signs of damage and whether the fixing rods on the trapeze bar are in good condition. The handle and fastening strap must be replaced at the following intervals:

- Every 2 years when cleaned with industrial bed-washing systems
- Every 3 years in hospital operation
- Every 5 years in care services

## 10. Other accessories

Other accessories must always be checked in accordance with the manufacturer's instructions.

## Troubleshooting | Table of faults

The following table contains information about possible malfunctions that can be resolved by the user.

Every person assigned with maintenance and service provision tasks must at least have read the safety regulations for the relevant bed model and be qualified in accordance with the relevant national regulations. The instructions for use and the service handbook for the bed must always be accessible to service staff to guarantee fault-free operation of the bed.

 **NOTE** Before conducting troubleshooting, always check that the bed is connected to the mains (mains plug in a live socket).

 **WARNING** Ensure that the bed is disconnected from the mains before starting repair work.

Fault	Possible cause	Remedy
Bed adjustment functions not working	Hand control unit locked Mains plug not connected or socket has no power Battery not working  Hand control unit not working  Mains plug not connected or socket has no power  Battery not working  2-minute adjustment cycle exceeded	Unlock the hand control unit Connect plug or check socket  Check/replace battery Check/replace mains cable Unlock hand control unit (p. 12) or connect plug or replace hand control unit  Unlock hand control unit (p. 12) or connect plug or replace hand control unit  Connect plug or check socket Check/replace battery Check/replace mains cable Wait until cooling cycle has elapsed (18 minutes)
Back section adjustment does not work	CPR lever obstructed	Check CPR lever for obstruction and repair or replace if required
Height adjustment of the bed does not work	Back section motor blocked	Press the "lying surface up/down" buttons simultaneously for approx. 10 seconds until the LED'S flash.
Thigh section motor does not work	Thigh section motor blocked	Press the "lying surface up/down" buttons simultaneously for approx. 10 seconds until the LED'S flash.
Lying surface motor does not work	Lying surface motor blocked	Press the "lying surface up/down" buttons simultaneously for approx. 10 seconds until the LED'S flash.
Mechanically adjustable lower leg section adjustment not working	Hydrolift faulty	Replace Hydrolift
Under-bed light (depending on configuration) not working	Hand control unit not connected or bulb faulty	Connect hand control unit or replace bulb

## Type plates | Symbols used

The type plates are located on the inside of the head panel.

Raise the back section to read the type plates. See below for the symbols used.

Each bed can be clearly identified from the unique ID number on its type plate.

The structure of this ID number is as follows:

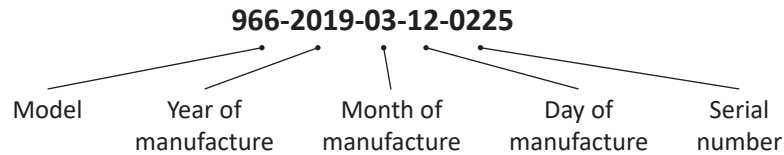

### Symbols on the type plates

	Manufacturer
	Model name
	Serial number
	Medical Device
	Maximum permitted patient weight
	Safe working load
	The product meets the essential requirements of Annex 1 of EU-Regulation 2017/745
	Type B applied part in accordance with DIN EN 60601-1
	Protection class II equipment, double-insulated
	Note the information in the instructions for use
	The device must be disposed of in accordance with EU Directive 2002/96/EC on waste electrical and electronic equipment
	Certified by TÜV SÜD (South German technical inspection association)

### Audible acoustic energy

Measured value	30.0 dB(A)
----------------	------------

### Warning signs and notes in the text

	<b>Warning sign</b> Information marked with this symbol must be read and strictly observed
	<b>NOTE</b> warns of possible material damage
	Warns of sources of electrical interference
	Protection class II or device with internal electrical power source
	Type B device
	Information arrow
	Direction arrows

### Labels

	Mass of the mobile medical device including safe working load
	Description of an adult: Weight: min. 40 kg Height: min. 146 cm BMI: min. 17
	Please read and observe the notes and instructions for use of the mattresses
	Warns of crushing and trapping hazard
	Do not sit here!

## Technical data | Classification

### Dimensions and weights



Height of lying surfaces (distance from floor to upper edge of wings on MiS® lying surfaces)	<p>Integral S single castors (Ø 125 mm) Lying surface height = 31.0 - 86.0 cm</p> <p>Integral single castors (Ø 150 mm) Lying surface height = 33.5 - 88.5 cm</p> <p>Integral S single castors (Ø 150 mm) Lying surface height = 33.5 - 88.5 cm</p> <p>Linea twin castors (Ø 125 mm) Lying surface height = 28.5 - 83.5 cm</p> <p>Twin castors (Ø 150 mm) Lying surface height = 33.0 - 88.0 cm</p> <p>Linea twin castors (Ø 150 mm) Lying surface height = 31.0 - 86.0 cm</p> <p>Twin castors (Ø 150 mm) Lying surface height = 35.0 - 90.0 cm</p>
External dimensions with lying surface 90 x 200 cm 100 x 200 cm	<p>Approx. 99.0 x 218.5 cm</p> <p>Approx. 109.0 x 218.5 cm</p>
<p>Height of bottom edge of lying surface frame</p> <p>Height of upper edge of lying surface</p> <p>Height of upper edge of head/foot ends</p>	<p>Approx. 14.5–70.0 cm depending on castor used</p> <p>Approx. 28.5–90.0 cm depending on castor used</p> <p>Approx. 64.0–125.5 cm depending on castor used</p>
Recommended mattress dimensions for lying surface 90 x 200 cm 100 x 200 cm	<p>88.0 x 200.0 x 12.0 cm*</p> <p>98.0 x 200.0 x 12.0 cm*</p>
Bed weight	Approx. 175 kg
Track width	Approx. 63.0 cm
Track length	Approx. 130.0 cm

\* We recommend the use of Völker mattresses. If other mattresses are used, please observe the notes on p. 16.

### Electrical data

Voltage	100–240 V AC
Power consumption	350 W
Nominal frequency	50 Hz/60 Hz
Primary fuse	4.0 A T
Duty cycle	2/18 min., 10% (maximum duty cycle 2 min., off time 18 min.)
Overcurrent trip	Maximum 14 A per drive
Operating temperature	+ 10°C to + 40°C
Storage temperature	- 10°C to + 50°C
Humidity	30% to 75% RH at 30°C, non-condensing
Air pressure	700 hPa to 1060 hPa
Operating height	Max. 3000 m above NHN

### Classification

Protection against electric shock	<p>Protection class II or device with internal electrical power source</p> 
Degree of protection in accordance with EN 60529	Complete bed: IPX4; IP66 electronics
Degree of protection of the application part against electric shock in accordance with DIN EN 60601-1	<p>Type B</p> 
Degree of protection against explosive substances and mixtures	The bed is not explosion-protected and must not be used in environments where flammable anaesthetics or flammable cleaning agents are present.
Grouping/ Classification as per Regulation (EU) 2017/745 Appendix VIII Rule 13	Class I
Technical inspection	1x annually (recommended)



### Service life

The bed's expected service life is approx. 10 years.

### Disposal information

- The operator must ensure that all components to be disposed of are not infectious/contaminated.
- If the bed is scrapped, the plastic and metal parts used must be separated and disposed of properly.
- If you have any questions, contact your local authorities, waste disposal companies or our service department.

### Disposal of electrical parts

- This bed is electrically adjustable and classified as a commercial (b2b) electrical device in accordance with the WEEE Directive 2012/19/EU (implemented in Germany in the Electrical and Electronic Equipment Act).
- The electrical components used are free of prohibited harmful constituents pursuant to the Restriction of Hazardous Substances II Directive 2011/65/EU.
- Replaced electrical components (drives, control units, hand control units etc.) from these beds are

to be treated and disposed of as electrical scrap in accordance with the WEEE Directive.

- The operator of this bed is legally obliged not to dispose of its electrical components at municipal collection points, but to send them directly to the manufacturer. Völker GmbH and its service partners will accept the return of these parts. Please contact our sales team in this regard.
- These returns are subject to our general terms and conditions.

### Disposal of batteries

- Any individual batteries that have been removed but that are no longer usable must be professionally disposed of in accordance with Directive 2006/66/EC (implemented in Germany in the Batteries Act); they must not be disposed of with general household waste.
- Contact your local waste disposal company or our service department.

In countries outside Germany/the EU, observe the applicable national regulations.

# Dimension sheets S 966 hospital bed

Bed with 90 x 200 cm lying surface (standard) and moving split side rails

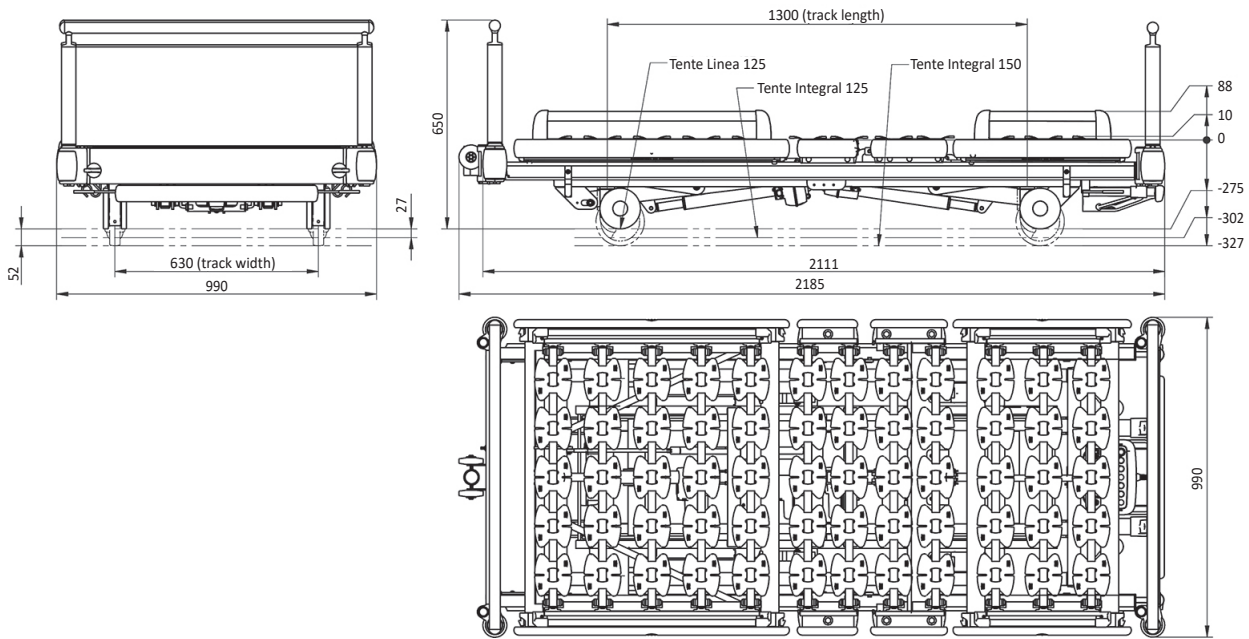

Bed with 90 x 200 cm lying surface (standard) and fixed split side rails

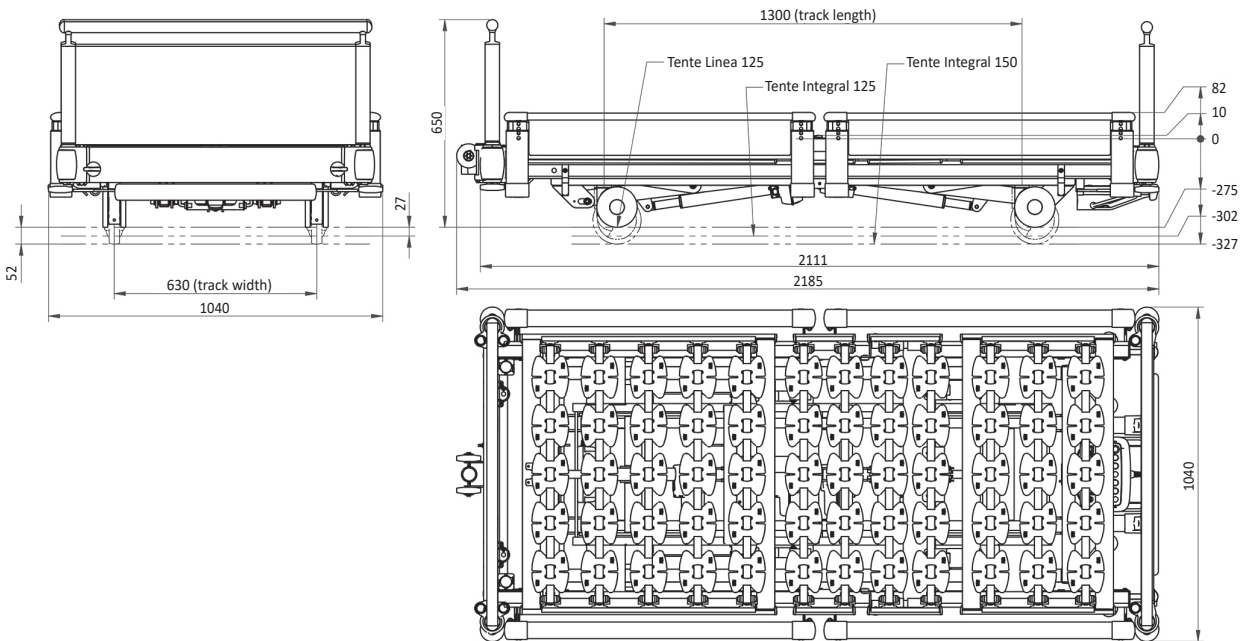

All dimensions in mm

## Manufacturer's declarations 1/2

Guidelines and manufacturer's declarations — electromagnetic interference		
The bed is intended for use in an environment as specified below. The customer or the user of the bed must ensure that it is used in an environment of this type.		
Emitted interference measurements	Compliance	Electromagnetic environment — guidelines
HF emissions in accordance with CISPR 11	Group 1	The bed uses HF energy exclusively for its internal functions. Its HF emissions are therefore very low and it is unlikely that neighbouring electronic devices will be affected by interference.
HF emissions in accordance with CISPR 11	Class B	The bed is suitable for use in all facilities, including households and facilities directly connected to a public power grid that also supplies residential buildings.
Emissions of harmonics in accordance with IEC 61000-3-2	Class A	
Emissions of voltage fluctuations/ flicker in accordance with IEC 61000-3-3	Compliant	

Guidelines and manufacturer's declaration — electromagnetic immunity			
The bed is intended for use in the electromagnetic environment specified below. The customer or the bed user must ensure that it is used in an environment of this kind.			
Immunity tests	IEC 60601 test level	Compliance level	Electromagnetic environment — guidelines
Discharge of static electricity (ESD) in accordance with IEC 61000-4-2	± 8 kV contact discharge ± 2 kV, ± 4 kV, ± 8 kV, ± 15 kV air discharge	± 8 kV contact discharge ± 2 kV, ± 4 kV, ± 8 kV, ± 15 kV air discharge	Floors must be made of wood or concrete, or should be covered with ceramic tiles. If the floor is covered with synthetic material, relative humidity must be at least 30%.
Electrical fast transients/ bursts in accordance with IEC 61000-4-4	± 2 kV 100 kHz repetition frequency	± 2 kV 100 kHz repetition frequency	The quality of the supply voltage must be that of a typical commercial, clinical or residential environment.
Surges in accordance with IEC 61000-4-5	± 0.5 kV, ± 1 kV differential mode ± 0.5 kV, ± 1 kV, ± 2 kV common mode	± 0.5 kV, ± 1 kV differential mode ± 0.5 kV, ± 1 kV, ± 2 kV common mode	The quality of the supply voltage must be that of a typical commercial, clinical or residential environment.
Voltage dips, short interruptions and fluctuations in the supply voltage in accordance with IEC 61000-4-11	0% UT for ½ cycle at 0°, 45°, 90°, 135°, 180°, 225°, 270° and 315° 0% UT for 1 cycle at 0° 70% UT for 25 cycles at 50 Hz at 0° 0% UT for 250 cycles at 50 Hz	1% UT for ½ cycle at 0°, 45°, 90°, 135°, 180°, 225°, 270° and 315° 0% UT for 1 cycle at 0° 70% UT for 25 cycles at 50 Hz at 0° 0% UT for 250 cycles at 50 Hz	The quality of the supply voltage must be that of a typical commercial, clinical or residential environment. If the bed user requires continued function even in the event of interruptions to the energy supply, it is recommended that the bed be powered by an uninterruptible power supply or a battery.
Magnetic field at the supply frequency (50/60 Hz) in accordance with IEC 61000-4-8	30 A/m 50 Hz	30 A/m 50 Hz	Magnetic fields at mains frequency should correspond to the typical values found in the commercial, clinical or residential environment. Devices that generate magnetic fields should be used at a distance of at least 15 cm from the bed.
COMMENT: UT is the AC mains voltage before application of the test level.			

## Manufacturer's declarations 2/2

Guidelines and manufacturer's declaration — electromagnetic immunity			
The bed is intended for use in the electromagnetic environment specified below. The customer or the bed user must ensure that it is used in an environment of this kind.			
Immunity tests	IEC 60601 test level	Compliance level	Electromagnetic environment — guidelines
Conducted HF interference on the power cable in accordance with IEC 61000-4-6 (no patient connections, DC connections or signal connections are present near the bed)	3 Vrms 150 kHz to 80 MHz 6 Vrms in ISM and amateur radio frequency bands between 150 kHz and 80 MHz 80% AM at 1 kHz	3 Vrms 150 kHz to 80 MHz 6 Vrms in ISM and amateur radio frequency bands between 150 kHz and 80 MHz 80% AM at 1 kHz	The bed is suitable for use in industrial, clinical and residential environments, but not in rooms containing magnetic resonance imaging (MRI) equipment or high-frequency surgical equipment.
Radiated HF interference in accordance with IEC 61000-4-3	10 V/m 80 MHz to 2.7 GHz 80% AM at 1 kHz	10 V/m 80 MHz to 2.7 GHz 80% AM at 1 kHz	Electronic devices must be used at a distance of at least 30 cm from the bed. The field strength of fixed radio transmitters must be lower than the compliance level for all frequencies in accordance with an on-site evaluation.  Interference may occur near devices bearing this symbol. 
High-frequency electromagnetic fields in the immediate vicinity of wireless communication devices in accordance with IEC 61000-4-3	TETRA 400 (380 to 390 MHz, 27 V/m) GMRS 460; FRS 460 (430 to 470 MHz, 28 V/m) LTE Band 13, 17 (704 to 787 MHz, 9 V/m) GSM800/900; TETRA 800; iDEN 820; CDMA 850; LTE Band 5 (800 to 960 MHz, 28 V/m) GSM 1800; CDMA 1900; GSM 1900; DECT; LTE Band 1,3,4,25; UMTS (1700 to 1990 MHz, 28 V/m) Bluetooth; WLAN 802.11 b/g/n; RFID 2450; LTE Band 7 (2400 to 2570 MHz, 28 V/m) WLAN 802.11 a/n (5100 to 5800 MHz, 9 V/m)	TETRA 400 (380 to 390 MHz, 27 V/m) GMRS 460; FRS 460 (430 to 470 MHz, 28 V/m) LTE Band 13, 17 (704 to 787 MHz, 9 V/m) GSM800/900; TETRA 800; iDEN 820; CDMA 850; LTE Band 5 (800 to 960 MHz, 28 V/m) GSM 1800; CDMA 1900; GSM 1900; DECT; LTE Band 1,3,4,25; UMTS (1700 to 1990 MHz, 28 V/m) Bluetooth; WLAN 802.11 b/g/n; RFID 2450; LTE Band 7 (2400 to 2570 MHz, 28 V/m) WLAN 802.11 a/n (5100 to 5800 MHz, 9 V/m)	Devices that use the listed radio services must be operated at a distance of at least 30 cm from the bed.

COMMENT 1: The higher frequency range applies at 80 MHz and 800 MHz.

COMMENT 2: These guidelines may not be applicable in all cases. The propagation of electromagnetic variables is affected by the absorbent and reflective properties of buildings, objects and people.

a The field strength of fixed transmitters, e.g. base stations for cordless phones and mobile radios, amateur radio stations, AM and FM radio and TV broadcasters, cannot in theory be predicted with any accuracy. A study of the site should be considered to determine the electromagnetic environment with regard to the location of the fixed transmitter. If the field strength measured in the location in which the bed is used exceeds the aforementioned compliance level, the bed must be monitored in order to verify that it is working as intended. If abnormal performance characteristics are observed, additional measures, such as reorientation or relocation of the bed, may be required.

## Information on electromagnetic compatibility (EMC)

Electromagnetic compatibility (EMC) refers to the ability of a technical device to refrain from affecting other devices with unwanted electrical or electromagnetic effects and to resist interference from other devices.

Appropriate construction and design are key to ensuring the electromagnetic compatibility of electrical equipment. The documentation and confirmation of resistance to interference and sufficiently low levels of emitted interference are regulated by EMC guidelines and EMC standards.

To ensure fault-free operation of the bed, please note the following:

- In isolated cases, strong interference can cause failure of adjustment functions, unwanted bed movements, continued adjustment even after release of a button, unwanted changes to the lock status or loss of height information. If effects of this nature are observed, try to increase the distance between the bed and the source of the interference, and to power the device causing the interference and the bed from different circuits. Unwanted movements can be stopped by pressing any button on a control unit (provided it is unlocked). Incorrect locking statuses can be corrected by pressing the appropriate buttons. A loss of height information indicates a failure of the height adjustment function. In this case, press the "Frame up" and

"Frame down" buttons simultaneously and hold for more than 10 seconds until movement ceases. This reference run updates the height information.



**WARNING** The bed must not be placed directly adjacent to or stacked with other devices. If operation near to or stacked with other devices is necessary, bed operation must be monitored. Intended function in the employed arrangement must also be verified.

- Only Völker original electrical spare parts must be used for repair and service work. Otherwise the aforementioned requirements may not be met. A list of electrical components can be found in the service handbook.
- Devices that emit radiation, such as mobile phones, must only be used at a minimum distance of 30 cm from the bed.
- Please also note the guidelines in the manufacturer's instructions (p. 53–54).

# Forms 1/2

## Technical check of Völker hospital and healthcare beds in accordance to German standards and safety regulations incl. measurements required



Project, address, customer no.:					
Type of bed, product, location of the bed:					
Bed Identification (e.g. facilities own identification or Völker ID-no.):					
Date of check:		Name of technician:			
Kind of check	Component to be checked	Annually	Accepted	Not accepted	Not applicable
Visual inspection	Inscription on device readable				
	Instructions for use available				
	Base frame	B*			
	Lying surface, wing and spring elements (if existing)	B*			
	Trapeze bar adapter, infusion bar adapter	B*			
	Power supply cable, plug or charger, charging connection	B*			
	Strian relieve, bend protection, cable hook	B*/S*			
	Connecting cable, plug-in contacts, blind plugs	B*/S*			
	Positioning (spacing 1 mm) and sensor cabling (only Vis-a-Vis-bed)	B*/S*			
	Housing (motor, control electronics)	B*			
	Hand control (housing, cable)	B*			
	Nurse keypad, nurse hand control (housing, cable)	B*			
	Trapeze bar, assist rail infill panel (side rail centre), additional accessories	B*/F*			
	Transverse motors and cover, head and foot ends	B*			
	Castors	B*			
	Wall buffer wheel (if existing)	B*			
Side rails including telescopic section, if applicable	B*				
HiLow-elevation: check screw locking (only for 5380)	S*				
Functional inspection of side rails including telescopic section, if applicable	Locking devices	X*			
	Deformation	X*			
	Abrasions	X*			
Functional inspection of drives with hand control and nurse keypad/nurse hand control	Back section, upper leg section, lower leg section, height adjustment, Trendelenburg position, reverse Trendelenburg position, length adjustment (only for Vis-a-Vis-bed) - approach all end positions	X*/M*			
	Angle limitation (back section to upper leg section >90°)	X*			
	Adjustment lower leg section (rastomat/hydrolift/support plate)	X*			
	CPR function (if existing)	X*			
	Brake (electrical or mechanical) - brake applied - free running	X*			
	(only for hospital beds and - steering position S 280/S 310/S 380/S 282/S 382 (Vis-a-Vis))				
Mechanical release (only for electrical brakes of hospital beds)	X*				
Functional inspection replacement	9 V battery (only for beds with Oki-/Ilcomat except S 960-1W/S 961) Replaced (yes/no)	A2*			
	Trapeze bar handle and belt (if existing) Replaced (yes/no)	A*			
Functional inspection miscellaneous	Bed extension (if existing)	B*			
	Bedding storage/bedding drawer (if existing)	B*			
	Inspection of the adhesive joints on headboard and footboard (if existing)	B*			
Comment					
Legally relevant for Germany only (in accordance to DIN EN 62353)	Leakage current by means of alternative measurement $\leq 500 \mu\text{A}$		$\mu\text{A}$		
	Potential equalization impedance < 0.2 Ohm (if existing)		$\Omega$		
	Measuring instrument S/N				
<b>Total result of the inspection:</b>					
Signature of technician:		Next regular inspection:			

A\*: To be replaced every 5 years for handles (H) and for H with roll function (RF) in nursing home mode, every 3 years for H with RF in hospital mode, every 2 years for H with RF for cleaning in automatic bed washing systems A2\*: To be replaced every two years B\*: Check for damage F\*: Check for deformation M\*: Check function of motors and end switches, does the motor switch off when reaching the end position? S\*: Check for correct fit X\*: General function control



**Spare Part Order/Repair Order**



Völker GmbH  
Service  
Wullener Feld 79  
58454 Witten/Germany

Tel.: +49 2302 96096-0  
Fax: +49 2302 96096-66  
E-Mail: service@voelker.de

Spare part order  Repair order

Address: \_\_\_\_\_

Contact person: \_\_\_\_\_

Street address: \_\_\_\_\_

Zip code/city/country: \_\_\_\_\_

Telephone number: \_\_\_\_\_

Customer number: \_\_\_\_\_

Customer order number: \_\_\_\_\_

Purchase order date: \_\_\_\_\_

Signature: \_\_\_\_\_

(Please, to fill in the form use block letters)

Stamp



Shipping address, if differently from the billing address

Address: \_\_\_\_\_

Street address: \_\_\_\_\_

Zip code/city/country: \_\_\_\_\_

Attention of: \_\_\_\_\_

Please, fill out all information carefully and complete in the form, otherwise we have problems in delivery and processing this order.

MODEL (Bed-type)	SERIAL NO./YEAR OF MANUFACTURE (Identification label inside of the bed-head)	SPARE PART DESCRIPTION/ERROR DESCRIPTION	ITEM NUMBER	QUANTITY	LOCATION OF THE BED (only for repair order)

Contact person / telephone number for repair orders: \_\_\_\_\_

(Please, to fill in the form use block letters)

## Available accessories

If you have any questions about accessories for this bed or if you wish to order accessories, please contact Völker GmbH.



# VÖLKER

Völker GmbH · Wullener Feld 79 · 58454 Witten · Germany · Tel. +49 2302 960 96-0 · Fax +49 2302 960 96-16  
[www.voelker.de](http://www.voelker.de) · [info@voelker.de](mailto:info@voelker.de)

HB-RD-000046 Rev.7