

VÖLKER





Instructions for use
Models 2082, 3082, 3082 K

Help

Hyperlinks

Hyperlinks are cross-references in the text. They are marked with the  symbol. Entries in the table of contents also have hyperlink functionality.

- Clicking  takes you to the relevant page.
- Clicking  in the Acrobat navigation bar takes you back to the start page.

Full-text search for a term

- Clicking  opens the "Search" window.

You can search for any term in this Acrobat document or optionally search all of the Acrobat files stored on your computer or those that are accessible.

Other interactive functions

The Adobe Reader and all Adobe Acrobat program versions offer the experienced user a whole raft of highly useful functions for interactive working with documents. For more information, see the relevant user manuals or online help.

Display table of contents



Contents

2 of 88

Jump to Help page (this page)



Help

Version, Imprint, Type label

Instructions for use G81

Rev. 3 (03.2018)

for Völker bed models 2082, 3082,
3082 K, built after June 2009

© by Völker GmbH 2009-2012

Völker GmbH
Wullener Feld 79
58454 Witten

GERMANY

Tel.: +49 2302 96096-0
Fax: +49 2302 96096-16
e-mail: info@voelker.de
Internet: www.voelker.de

All rights reserved. Reproduction - even
in part - is not permitted.

We reserve the right to make changes
to reflect technical advances.

The contents of this document are sub-
ject to change without prior notification.

Customers are advised to contact the
responsible area sales manager before
placing an order.

Type label

Völker GmbH - Wullener Feld 79 - 58454 Witten - Germany
Phone +49 2302 96096-0 - Fax +49 2302 96096-16
service@voelker.de - www.voelker.de

NURSING BED Model 3082
ID-No. 3082-2012-13-263 /D
Input: 230 V; 50 Hz; 300 VA
Physical life time: 4 min./10 min.
Unsuitable for automatic washing system
Leakage current: 57 µA

Degree of protection: IPX 4

Made in Germany

= 250 kg = 215 kg

TÜV NRTL US
CE
Next technical control
13/2013

The type label is located on the inside of
the head panel.

Raise the back section to read the type
label.

For further information on the type label,
see Appendix 72.



Table of contents 1/2

Help	2	Activation	30	Cleaning and disinfection	51
Version, Imprint, Type label	3	General operating instructions	31	Cleaning	52
Table of contents	4	Preparation	32	Wipe and spray disinfection	52
Foreword	6	Electrical activation	33	Spray lances and automatic washing systems	53
		Using the battery pack	34		
Notes	7	Taking out of service	35		
General information	8	Functional check	36	Maintenance	54
Designated purpose	9			Staff training	55
General regulations, training/ instruction of users, further requirements	11	Operation	37	Safety notes	55
General safety notes	12	Key lock	38	Maintenance schedule	56
		Castors	39		
Functional description	17	Side rails	40	Technical check	57
Overview	18	General safety notes	40	Visual inspection	58
Model 2082	18	Model 2082	41	Functional check of the side rails	58
Models 3082, 3082 K	19	Models 3082, 3082 K	42	Functional check of the brakes	60
Hand control with hook	20	Back section	44	Functional check of the motors	60
Transverse hand control (option for 3082, 3082 K)	21	Mech. rapid lowering of the back section / CPR function (option)	45	Mains connection cable	60
Nurse keypad (option)	22	Upper and lower leg sections	46	Cabling	60
with complete lock (option)	23	Lying surface height	47	Housing	60
with individual lock (option)	24	Anti-Trendelenburg and Trendelenburg positioning (option)	48	Mechanical check	60
Trapeze bar and accessory holders, accessory rail	25	Comfort seating position (option)	49	Measuring in accordance with DIN EN 62353 (VDE 0751-1)	61
Versions and options	26	Bed extension (option)	50	Checking the trapeze bar grab handle	61
Accessories	28				

Table of contents 2/2

Further accessories	61
Troubleshooting	62
Table of faults	63
Service points	66
Appendix	67
Symbols used	68
Technical data	69
Classification	71
Type label	72
Service life/disposal	74
Manufacturer's declarations, forms, electronic instructions for use	75

Foreword

We are delighted that you have chosen Völker beds.

We are also grateful for the trust you have placed in our company and our products.

This step is undoubtedly the result of extensive considerations and examinations of the requirements that you require on new care or hospital beds based on your previous experiences.

You clearly had good reasons to choose Völker care beds.

We promise you that Völker beds will not disappoint you.

Not for nothing do Völker beds enjoy a worldwide reputation as particularly innovative medical aids. This refers not

only to the design principle, which was completely redeveloped by Völker. It also refers to the multitude of product advantages which were continually tested and improved for their practicality. These will support the comfort of the occupant/patient and also help reduce the load of daily care work.

Now, every care or hospital bed has product features that are of practical benefit to their users. However, as far as we know, none of them offers the range of advantages that a Völker bed does.

Völker beds not only look great, but they also offer functions that can be controlled or adjusted mechanically, although most of them are controlled or

adjusted using electric motors or electronic components.

If you purchase these beds, the responsibility for their correct and appropriate use is transferred to you. Consequently, we strongly advise that you consult the enclosed instructions for use to learn about the technical features, handling and use of all the functions.

We wish you every success with Völker beds,

yours Völker GmbH

Notes

The **Notes** section contains information on the designated purpose of the product, as well as general safety notes.

CONTENTS

General information	8
Designated purpose	9
General regulations, training/ instruction of users, further requirements	11
General safety notes	12

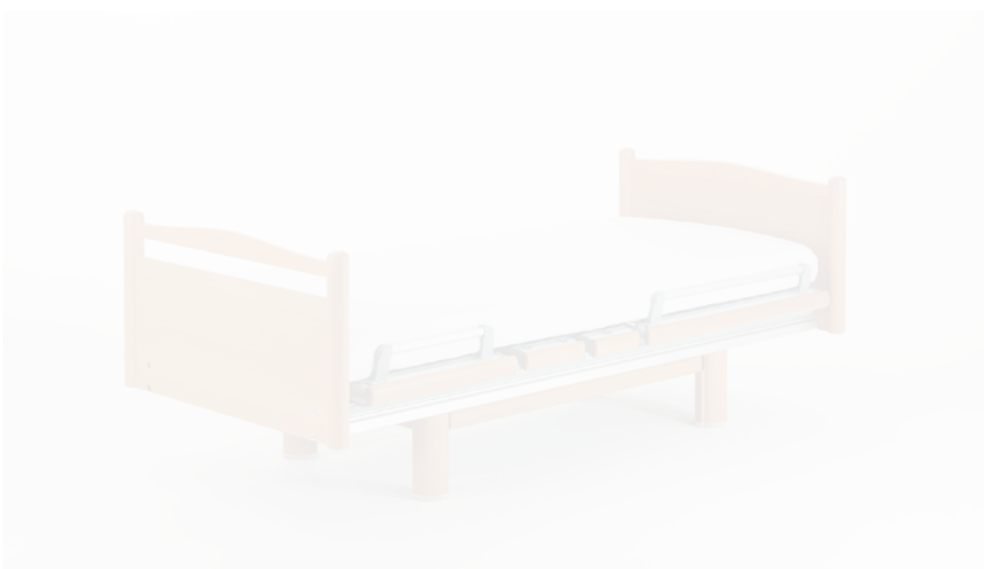

Notes | General information

General notes

You have purchased a bed from Völker GmbH. This bed has been built in accordance with the applicable national and international standards and the regulations reflecting the current state of technology.

Völker beds satisfy requirements in terms of safety and functionality. They are tested in accordance with international standards and bear the CE mark, which documents the beds' compliance with essential requirements for medical products.

Please read the general safety notes  12. Please also note (with particular attention to any warranty claims) the further notes on the following pages.

Standard design

The standard design of the bed can be supplied with various options. A description of these options can be found in the section entitled Versions and options  26.

Copyright protection

These instructions for use may only be transferred to third parties with the written consent of Völker GmbH. All documents are protected under copyright.

Warranty and liability

Völker GmbH is liable for any faults or failures, not including further claims, arising in the context of the warranty obligations detailed in the main agreement. Claims for compensation, for whatever legal reason such claims may be raised, will not be entertained.

We reserve the right to make technical modifications without notice as part of the further development of the beds which form the subject of these instructions for use. All specifications are non binding. Printing errors excepted.

We accept no liability for damage and operational faults caused as a result of misuse and/or non-observance of these instructions for use.

The portrayal of the accessories does not necessarily match the actual product.

Notes | Designated purpose 1/2

Intended use

Völker bed models 2082, 3082 and 3082 K are beds for medical use and are intended for the laying down and care of occupants/patients in care institutions, hospitals and in suitable rooms in residential buildings.

The bed is intended for use by people over the age of 12 or who are taller than 146 cm.

The bed's safe working load is 250 kg. The maximum permissible weight of the individual is derived by deducting the weight of the mattress, the trapeze handle and other accessories from this.

Any use of the Völker bed other than for the purpose intended excludes the company from any possible liability.

None intended use

None intended use can be dangerous. This includes, but is not limited to:

- Incorrect actuation of electrical functions and uncontrolled positioning
- Operation of the care bed by the occupant/patient without having received prior instruction in how to do so
- Use of other electrical equipment on the bed
- Pulling on cables to move the bed
- Removing electrical plug connections by pulling on the cable
- Use of the bed on a slop of more than ten degrees of inclination (the bed's brakes are designed for an angle of inclination of no more than ten degrees)
- Any attempt to move the bed while it is in braked position

- Use of the bed to transport people
- Use of the bed for transport with a vehicle
- Overloading of the bed beyond the specified safe working load.



CAUTION If, in an emergency situation, it is impossible to avoid putting children under the age of 12 or people who are less than 146 cm tall in the bed, protective covers must be placed on the side rails. This also applies to the use of the bed by weak or confused patients.

The use of the bed for children under the age of 8 is absolutely forbidden.



WARNING The bed may not be placed right next to or stacked up with other equipment. If operation near to or stacked up with other equipment is necessary, it must be ensured that the operation of the bed is observed and correct use in this arrangement is checked.

Notes | General regulations, user training / instruction, further requirements

General regulations

The bed must only be operated and used in accordance with its designated purpose, in line with the conditions of the Medical Products Directive (MPG) and approved legislation pursuant to this, the generally-acknowledged rules of technology and the stipulations of occupational safety and accident protection guidelines. The bed must **not** be operated in a faulty state that could endanger its occupant/patient, care personnel or third parties.

User training

The bed may only be operated by individuals whose training or understanding and experience offer surety for correct handling (Medical Products Directive).

User instruction

The thorough induction of care personnel in the operation of the bed can be provided by Völker or its representative at the customer's request.

Attendance of such training can be certified and confirmed by Völker using the form provided for this purpose, specifying the name, date and signature.

Occupants/patients must be instructed in the use of the bed before care personnel hand over the hand control to them.

Other requirements

Whoever is in charge of the activation, operation or preparation of the bed must have been given a copy of these instructions for use (in printed or electronic form) and have read them.

To avoid operating errors and to safeguard the smooth operation of the bed, care personnel must always have access to the safety notes below.

Flooring requirements

Increasingly overweight patients and occupants have caused a consistent increase in demands on hospital and care beds in recent years. Völker has addressed this topic by increasing the "safe working load" for the bed. However, not only the beds are exposed to higher levels of strain, but also static and also flooring. Therefore, we recommend that flooring in areas where the beds are used which is designed for this strain. These are floor coverings classified as at least class 32 or 33 in accordance with DIN EN 685 and properly laid. These are floor coverings for areas intended for public and industrial use with moderate or heavy traffic.

Notes | General safety notes 1/5



Warning symbols

Information marked with this symbol must be read and its content strictly observed.



DANGER represents an immediate threat of danger that can cause serious physical injury or death.



WARNING represents potentially dangerous situations that can lead to serious physical injury or death.



CAUTION represents potentially dangerous situations that can cause slight physical injuries.

NOTE warns of potential damage to objects or property.

Before first activation

Before the bed is put into action for the first time, care personnel must read these instructions for use in full and with care.

Before the bed is activated for the first time, care personnel must be instructed in the handling of the bed using the instructions for use. The potential dangers that can arise despite correct operation of the bed must also be pointed out in full.

Before and during use

Before each use of the bed, the user must be sure that the bed is in a good, safe condition and that safe use is ensured (Functional check  36).



WARNING If other equipment which has cables, air pipes or the like is to be operated on the bed, it must be ensured that these cables are routed so that they cannot become trapped in the movable parts of the beds and thus be damaged.

Position of the bed





CAUTION To avoid injuries caused by falling, we recommend (except while care is being given) that the bed is generally set at its lowest position with the brake activated.

Transporting the bed

 **CAUTION** The bed is not designed for transporting people. When moving the bed, it must always be ensured that the mains connection cable does not touch the ground and that the lying surface is in a horizontal position as low as possible. The bed should only be moved on a solid floor. Never attempt to push it over obstacles of over 1 cm in height. The maximum angle of inclination of the floor must not exceed 10°.

Securing the bed

 **CAUTION "Risk of accident"** If the bed is not being transported, the castors must always be raised, since the bed may be required as a support for when the occupant/patient stands up or lies down. If the bed rolls away while the castors are down, this can lead to a serious fall. Once the castors have been raised  39, it must be checked that the bed is actually securely parked, i.e. the castors are completely raised. The bed can be in a non-fully-braked status even after first activation or reactivation, and consequently it must be checked that the castors are correctly raised.

One-sided load on the bed

 **NOTE** In order to prevent one-sided loads on the bed, it must not be used as a seat for persons other than the occupant/patient (i.e. visitors must not sit on the edge of the bed).

Side rails

 **WARNING "Risk of entrapment"** In the case of occupants/patients whose physical or mental condition makes it necessary to use side rails to protect them from falling out of bed, the following safety measures must be observed:

- The legal permissibility of using side rails must be ascertained.
- The side rails may only be operated by trained care personnel.

Notes | General safety notes 3/5

- Ensure that the side rails (or parts thereof) are either fully raised and locked in position or completely lowered.
- It must be ensured that the occupant does not come into contact with the side rail elements when the electrical lying surface adjustment mechanism is actuated. It is also important to ensure that no part of the body is sticking out through the side rails.
- If the side rails are used with a person whose psychological condition makes their use necessary, then it must be ensured that the hand control is kept out of their reach or its functions are locked. In addition, it is strongly recommended that side rail covers are used.

 **DANGER** If these safety measures are not observed by care personnel, injuries can be caused to hands, knees, fingers, feet, legs and hips, along with haematomas and other injuries as a result of entrapment. In children or people who are less than 146 cm tall, non-observance of these guidelines can lead to death!

 **WARNING** "Risk of entrapment"
On model 2082, the side rails must either be fully raised and securely locked in position, or be completely lowered.

 **WARNING** "Danger of injury"
If the side rails are damaged, the bed must not be used and must be repaired.

Height adjustment

 **DANGER** "Risk of entrapment between the lower frame and/or floor and the bed frame when the bed is lowered"
It must be ensured that no people, limbs, pets, bed linen or other objects are caught between the bed frame and the lower frame and/or floor.

 **DANGER** "Danger of movement"
If any movement of the bed could represent a danger to the occupant/patient, all functions must be locked.

Accessories

-  **WARNING "Risk of injury"**
Only original Völker accessories should be used! Third-party accessories must be subjected to testing before use.

Use of lifting devices

-  **WARNING "Risk of injury"**
No lifting device must be fastened directly to the bed (patient transport, repair).

The lifting devices specified are appliances that can be attached to the bed for transport purposes. Patient lifters can be used.

Use of oxygen equipment

-  **DANGER "Risk of fire"**
Do not use any oxygen equipment other than that which is administered via nasal prongs or masks. Do not use this bed in a room where there is a risk of explosion.
Provided it has been excluded (e.g. based on information in the instructions for use of the equipment being used) that the use of the equipment may cause the O₂ concentration to rise to such a degree that there is an explosion risk, then the equipment can be used.

Rail spacer

When using the rail spacer, please read the separate instructions for use for this accessory. During technical checks, the rail spacers should also be checked to ensure they are suitable for the size of side rail used.

Cleaning and disinfection

In order to maintain consistent functioning, the bed should be cleaned, disinfected and tested as soon as possible following each use, so that it can be reused immediately without risk.

Incorrect cleaning/disinfection  51 of the bed can cause danger.

Notes | General safety notes 5/5

Maintenance and repair

Anyone responsible for carrying out maintenance and repair work must at least have received instruction from Völker in the service tools, have read the safety notes and the service manual and be qualified in accordance with MPBetreibV §§ 4 and 6.

After maintenance work or repairs have been carried out, a Technical check  57 must be carried out on the affected parts and/or functions. During this check, it must be determined that the bed can be used in accordance with the specifications without risk to occupants/patients, users or third parties.

The Technical check must be carried out at least once a year and after every lengthy period of non-use.

Any discernible damage, such as signs of wear and tear, loose screws or breaks/fractures must be eliminated immediately.

Electromagnetic / static interference

The beds in model series 2082, 3082 and 3082 K satisfy the EMC requirements in accordance with the law on medical products (MPG). The basis for testing is standard EN 60601-1-2.

Functional description

The features of the Völker care bed and its function are set out in the section **Functional description**.

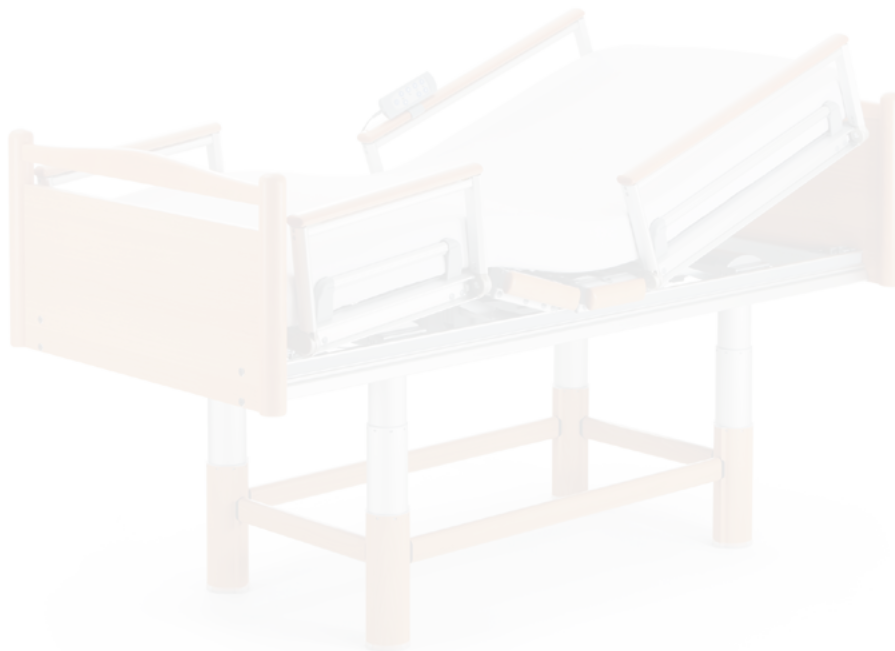

CONTENTS

Overview	18
Model 2082	18
Models 3082, 3082 K	19
Hand control with hook	20
Transverse hand control (option for 3082, 3082 K)	21
Nurse keypad (option)	22
with complete lock (option)	23
with individual lock (option)	24
Trapeze bar and accessory holders, accessory rail	25
Versions and options	26
Accessories	28

Functional description | Overview of model 2082

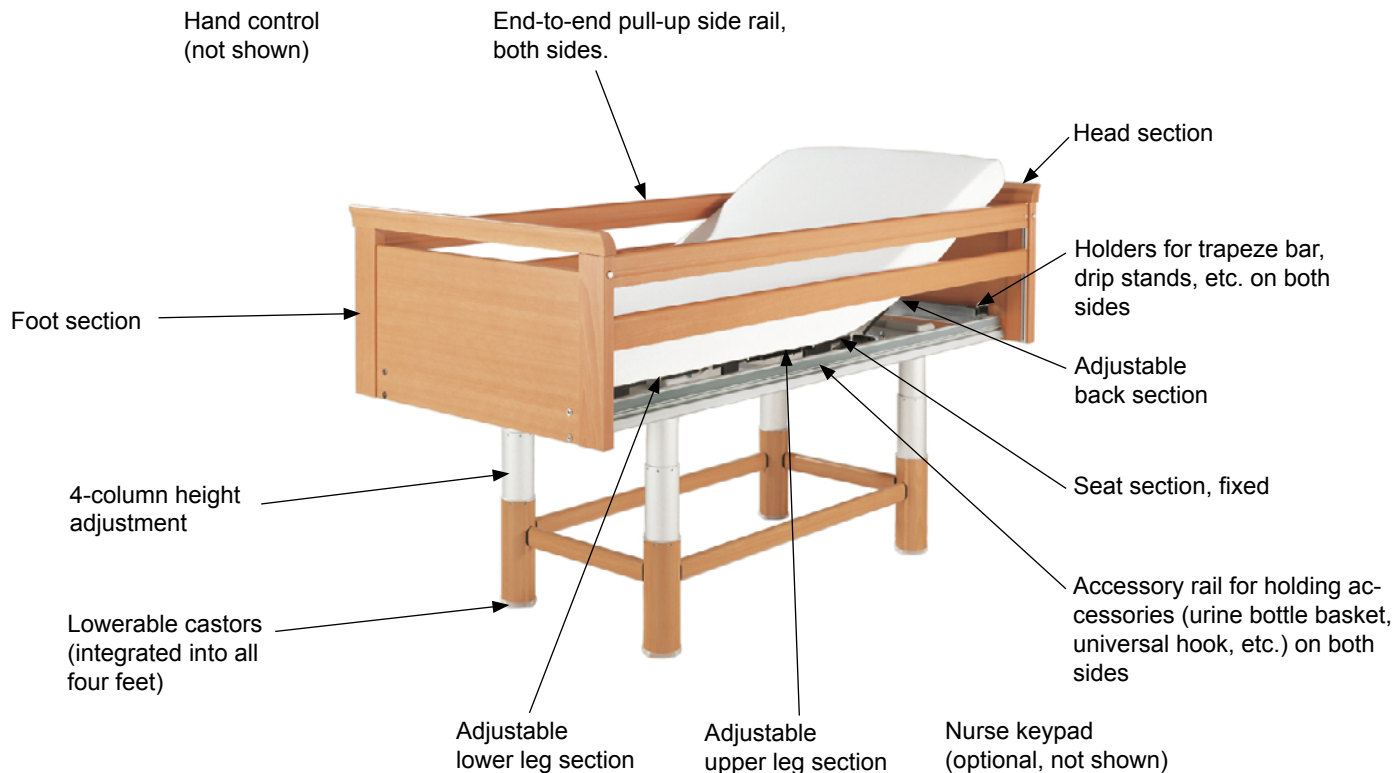

Functional description | Overview of models 3082, 3082 K

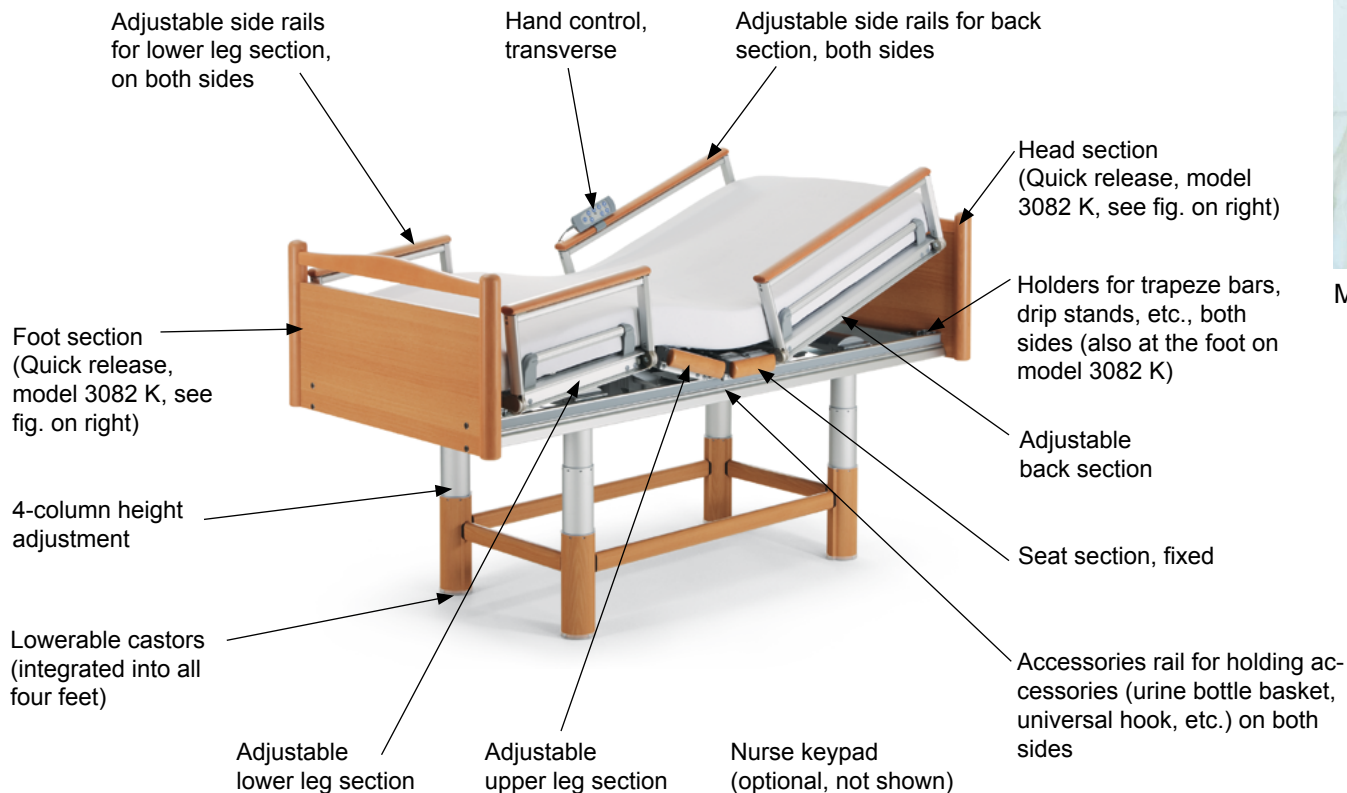

Model 3082 K

Functional description | Hand control with hook

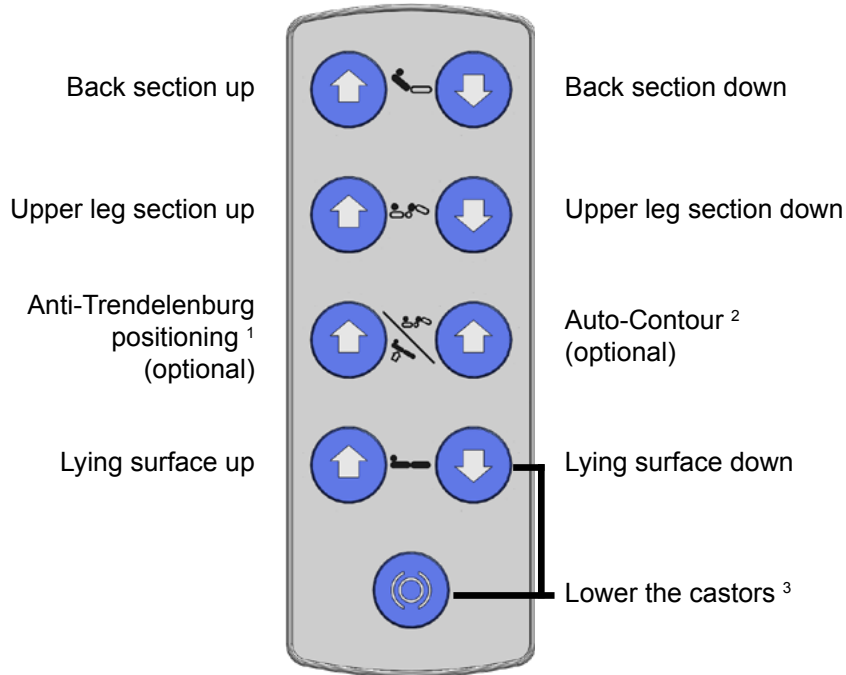

Reverse:



Hand control locked



Hand control unlocked

¹ Head end raised

² Back and upper leg section raised simultaneously

³ Press both buttons simultaneously:

the lying surface moves to the lowest position and the castors lower



WARNING When actuating motorised adjustments with the side rails raised, it must be ensured that the occupant/patient does not have any contact with the side rails, and that no parts of his or her body or those of other people are sticking through the side rails or are trapped between the lying surface and the lower frame and/or floor!

Functional description | Transverse hand control (option for 3082)

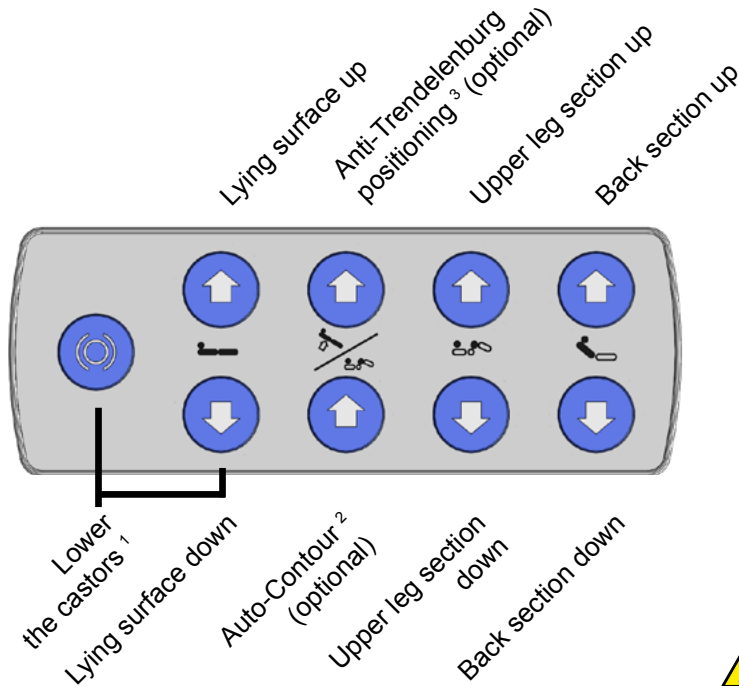

- ¹ Press both buttons simultaneously: the lying surface moves to the lowest position and the castors lower
- ² Back and upper leg section raised simultaneously
- ³ Head end raised

Reverse:

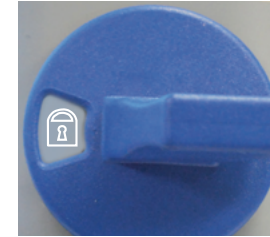

Hand control locked



Hand control unlocked



WARNING When actuating motorised adjustments with the side rails raised, it must be ensured that the occupant/patient does not have any contact with the side rails, and that no parts of his or her body or those of other people are sticking through the side rails or are trapped between the lying surface and the lower frame and/or floor!

Functional description | Nurse keypad (option) 1/3

NOTE Please note that to operate the bed, the nurse keypad must be switched on by pressing the on switch. If no electric function can be activated, press the green reset button on the engine housing. If the battery display then lights up red, briefly disconnect the mains plug.

Press the green button on the mains isolation switch after reconnecting the mains plug to put the bed back into operation.

Never press both green buttons at the same time.

NOTE The mains voltage is connected for the duration of the active time of the nurse keypad (120 sec.), so that the LED of the mains voltage display also lights up whenever the nurse keypad is active. If the keypad switches over to the inactive state, the mains power is switched off.

Double-click function

The nurse keypad can be equipped with an automatic function (double-click) on a country-by-country basis.

With a double-click on the "Lying surface up" or "Lying surface down" button, for example, the lying surface moves to the highest or lowest position, respectively. This function can be stopped at any time by pressing any button (except the on switch).



WARNING **"Risk of entrapment"**

If the double-click function is being used, the care giver must supervise the occupant/patient until the adjustment procedure has completed.



DANGER "Risk of entrapment between the lower frame and/or floor and the bed frame when the bed is being lowered"

It must be ensured that: no people, limbs, pets, bed linen or other objects are trapped between the bed frame and lower frame and/or floor during adjustment manoeuvres.

Functional description | Nurse keypad with complete lock (option) 2/3

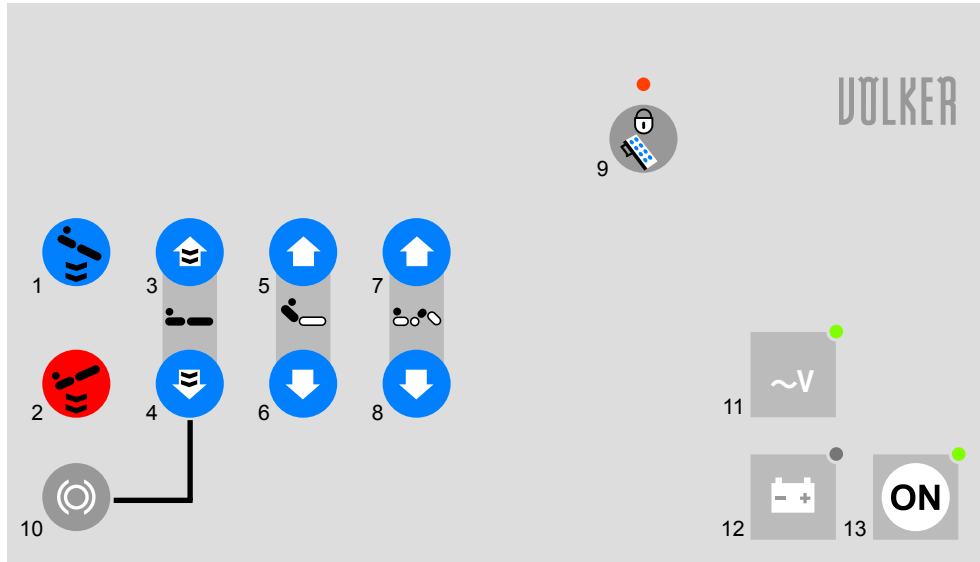

- 1 Anti-Trendelenburg positioning ^{1,7}
- 2 Trendelenburg positioning ^{2,7}
- 3 Lying surface up ⁷
- 4 Lying surface down ⁷
- 5 Back section up
- 6 Back section down
- 7 Upper leg section up

- 8 Upper leg section down
- 9 Lock hand control
- 10 Lower the castors ³
- 11 Mains voltage display ⁴
- 12 Battery display ⁵
- 13 On Switch ⁶

- ¹ Head end raised
- ² Head end lowered
- ³ Press both buttons simultaneously: the lying surface moves to the lowest position and the castors lower
- ⁴ green: mains voltage is on
- ⁵ green: >80% charged; yellow: 30-80% charged; red: discharged; flashing: charging
- ⁶ after pressing the button, the keypad is available for up to 120 sec. after the last action, then it locks automatically
- ⁷ automatic function with double click possible on a country-by-country basis



WARNING When actuating motorised adjustments with the side rails raised, it must be ensured that the occupant/patient does not have any contact with the side rails, and that no parts of his or her body or those of other people are sticking through the side rails or are trapped between the lying surface and the lower frame and/or floor!

Functional description | Nurse keypad with individual lock (option) 3/3

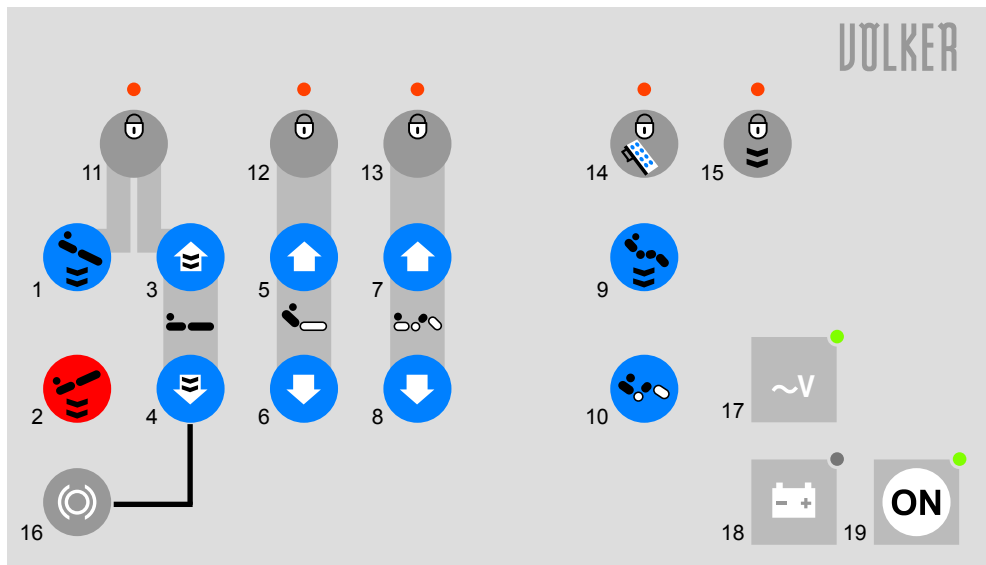

- 1 Anti-Trendelenburg positioning ^{1, 8}
- 2 Trendelenburg positioning ^{2, 8}
- 3 Lying surface up ⁸
- 4 Lying surface down ⁸
- 5 Back section up
- 6 Back section down
- 7 Upper leg section up
- 8 Upper leg section down
- 9 Cardiac chair position ⁸
- 10 Auto-Contour ³

- 11 Lock lying surface lift and anti-Trendelenburg positioning
- 12 Lock back section
- 13 Lock upper leg section
- 14 Lock hand control
- 15 Lock automatic function
- 16 Lower the castors ⁴
- 17 Mains voltage display ⁵
- 18 Battery display ⁶
- 19 On Switch ⁷

- ¹ Head end raised
- ² Head end lowered
- ³ Back and upper leg section raised simultaneously
- ⁴ Press both buttons simultaneously: the lying surface moves to the lowest position and the castors lower
- ⁵ green: mains voltage is on
- ⁶ green: >80% charged; yellow: 30-80% charged; red: discharged; flashing: charging
- ⁷ after pressing the button, the keypad is available for up to 120 sec. after the last action, then it locks automatically
- ⁸ automatic function with double click possible on a country-by-country basis



WARNING When actuating motorised adjustments with the side rails raised, it must be ensured that the occupant/patient does not have any contact with the side rails, and that no parts of his or her body or those of other people are sticking through the side rails or are trapped between the lying surface and the lower frame and/or floor!

Functional description | Trapeze bar and accessory holders, accessory rail

On the inside of the head panel are holders for the trapeze bar and accessories. On model 3082 K, there are two additional sockets for drip stands at the head and foot ends, next to the protective wheels.

The trapeze bar and other accessories must be slotted into the holders until they audibly engage.



WARNING "Risk of injury"

Ensure that the trapeze bar is completely slotted into the holder and securely seated.

Note: the safe working load of the trapeze bar is max. 75 kg.



WARNING "Risk of falling"

The trapeze bar must not be used by the occupant/patient as an aid for climbing into the bed. The trapeze bar must never jut out beyond the outer edge of the bed and then be used as a pulling-up aid (e.g. when getting out of a wheelchair).

Trapeze bar holders

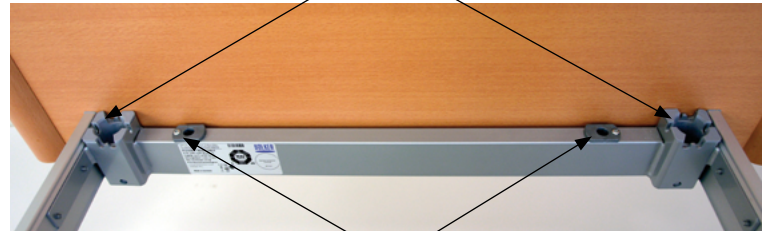

Accessory holders
(e.g. for drip stands, etc.)

There is an accessory rail on either side of the bed to accommodate accessories.



Accessory rail
(e.g. for urine bottle basket, universal hook, etc.)

Functional description | Versions and Options 1/2

The standard design of the bed can be supplied with various versions and options.

Independent of the fastening option, there are optional hand control and nurse keypads with different function keys.

Version/option	Description
----------------	-------------

Hand control (versions)	1. With hook (standard):
-------------------------	--------------------------



	2. Transverse on the side rail with clip (option for 3082, 3082 K):
--	---



Version/option	Description
----------------	-------------

Nurse keypad (option)	1. Transverse on the side rail with clip (option for 3082, 3082 K):
-----------------------	---



	2. On foot section with hook (optional):
--	--



	3. In bed linen storage area (option):
--	--



Functional description | Versions and Options 2/2

Version/option	Description	
Bed extension (option)	Models 3082 and 3082 K can be extended by 20 cm with a telescopic bed extension.	These instructions for use cover all of the versions and options listed.
Side rails (versions)	Models 2082 (except design versions C and LP), 3082 and 3082 K can be equipped with various side rail versions: Back/lower leg section*: <hr/> <ol style="list-style-type: none">1. Can be pulled out up to 34** cm (standard)2. Can be pulled out up to 45** cm (version for 3082 and 3082 K) Can be pulled out up to 38** cm (version for 2082) <p>* continuously for model 2082. ** Measured from the top edge of the side rails to the lying surface (without the mattress).</p>	Precise details of the supplied bed designs can be found in the order specifications for your beds. If the original bed specification is no longer available, please contact Völker Customer Services. Please make a note of the Völker serial number (ID No.) on the type label  72 before you call.

Functional description | Accessories 1/2

To offer the greatest possible degree of flexibility, Völker offers a wide range of easy-to-attach accessories. The beds are equipped as standard with holder devices for accessories, such as drip stands and trapeze bars. Urine bottle baskets, universal hooks, standard bars, etc., can be mounted on the accessory rails provided on both sides of the bed.

Further information about accessories can be found in our current information brochure or on the Internet at www.voelker.de. Our staff will gladly provide you with more details on the accessories that are available for your bed model.



WARNING Only original Völker accessories should be used! Third-party accessories must be subjected to testing before use.

Mattresses

Mattress size	Mattress frame size	Density
88 x 200/210/220 x 12 cm	90 x 200/210/220 cm	40-50 kg/m ³
98 x 200/210/220 x 12 cm	100 x 200/210/220 cm	40-50 kg/m ³

To minimise the risk of injury, only use mattresses with the dimensions and properties detailed above. If you do not use Völker mattresses, please contact a dealer in whom you have confidence.



DANGER If mattresses are used that do not match these specifications, there is a risk of suffocation!



DANGER The height of the raised side rails above the mattress must always be greater than or equal to 220 mm; otherwise the occupant/patient may accidentally fall out of bed. Please note that the height of the mattress has a direct influence on this.

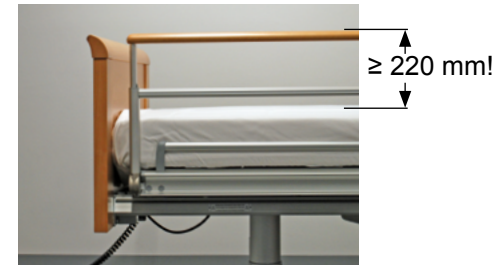

Functional description | Accessories 2/2

Use of securing systems

Securing systems such as belts or straps should only be used exactly as specified by the manufacturer.

If securing systems in the form of abdominal belts are used, then it must be ensured that the side rails are completely raised. In this case, the gap in the middle of the rails must always be closed using a rail spacer on models 3082 and 3082 K.

 **DANGER** When using securing systems and rail spacers, please note the separate instructions for use pertaining to these accessories.

If the patient is restrained with the help of restraint holders, the lying surfaces must **never** be adjusted while the patient is restrained **and** must always be in the lowest position!

The lying surface adjustment functions must be locked when a patient is secured, and the hand control must be kept out of the patient's reach!

Restraints may be fastened directly onto beds built after 08/2009.

To do this, fasten the restraints on the corresponding longitudinal section of the lying surface frame. Make sure that the restraint is passed between the mattress holder and the mattress.

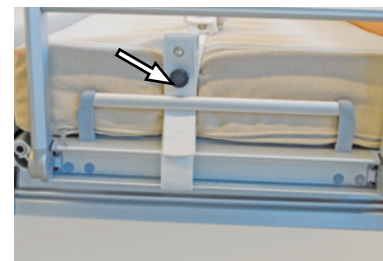

Activation

The section entitled **Activation** describes the preparation of the bed for use, including the functional check.



CONTENTS

General operating instructions	31
Preparation	32
Electrical activation	33
Using the battery pack	34
Taking out of service	35
Functional check	36

Activation | General operating instructions

On-time

The maximum on-time for the electro-motive bed functions is specified on the bed (type label  72) or in the technical data sheet.

4 min./10 min. means that each electro-motive adjustment may be operated for a maximum of 4 minutes in 10 minutes (protection against overheating).

NOTE Should the maximum on-time of 4 minutes be exceeded repeatedly or for longer periods, safety cut-out devices on the bed may cause the electromechanical motor system to shut down. The bed must not be manoeuvred using the motors until it has cooled down sufficiently!

Battery pack

The battery pack integrated into the double drive has a charge capacity that is equivalent in theory to a constant operation of at least 4 lifting and lying surface adjustments with a working load of 250 kg.

NOTE If the bed is parked at its location and the mains plug is not connected, this will cause the battery pack to discharge due to the buffering of the electronic components!

Deep-discharged battery packs can be damaged to the extent that premature replacement is needed!

To increase the stand-by time, it is recommended to activate the reset button on the housing when storing the bed and to disconnect the bed from the mains. The bed should not be stored for a period longer than 6 months with a fully charged battery pack without recharging it.

Appropriate and correct use of the battery pack is essential for it to have a long service life!

In order to guarantee electrical functionality at all times, the bed should be connected to the mains as much as possible.

Safety cut-out device

The bed is equipped with an electrical, self-resetting safety cut-out device that prevents overloading of the motor systems. In the event of very severe overloading, the bed is automatically switched off.

Activation | Preparation

Conditions for set-up

The bed is only approved for use in dry rooms (technical data sheet). A mains power supply and possibly a potential connector are required for operation of the bed in any suitable room. When this is available and the building installation permits it, the bed should always be connected to the potential equalisation.

Mechanical activation

The supplied head and foot sections must be slotted into the corner connectors on the bed frame (only for model 3082 K).

Hand control connection

The hand control should be connected to the socket provided, where appropriate. The spiral cable must be routed so that it is not under tension.



Routing the hand control cable

Bed transport

The bed can be moved without auxiliary transportation devices. To do this, set the bed to transport mode (lower the castors  39).



CAUTION The bed is not designed for transporting people. If a patient is lying in the bed, it must only be pushed within the room. The bed should only be moved on a solid floor. Never attempt to push it over obstacles of over 1 cm in height. The maximum angle of inclination of the floor must not exceed 10°.

NOTE The bed must be transported by at least two people, taking hold of the bed at the head and foot section.



Bed transport by at least two people

Activation | Electrical activation

⚠ WARNING Ensure that the plug connection between the mains cable and the lying surface adjustment motor is correctly positioned!

⚠ WARNING Check the mains cable for damage. If the cable is damaged, the bed must not be used and must be taken out of service immediately!

NOTE Please be aware that incorrect handling of the mains isolation switch can lead to the battery pack no longer charging. Incorrect handling can include dropping the mains isolation switch, pulling the mains plug cable to release it from the socket and driving over the cable when transporting the bed.

1. Connect the mains plug to the mains power socket.
2. Press the green button on the mains isolation switch for one second to isolate the mains connection.



3. Unlock the locking switch on the reverse of the hand control using the key (open lock visible) in order to activate the bed's electrical functions.



Activation| Using the battery pack 1/2

The battery pack allows the bed to be operated independently of the mains supply for at least four adjustment cycles.

The battery status can be monitored by connecting a further nurse keypad with LEDs.

The LED of the battery display on the additional nurse keypad displays three colours:

Green	The battery pack is more than 80% charged.
Yellow	The battery pack is 30-80% charged.
Red	DANGER ZONE. Battery pack is discharged.
Flashing	The battery pack is being charged.

If the LED is red or yellow, the battery pack needs to be recharged. The battery pack is switched off shortly before deep discharging. After the bed is connected to the mains supply, press any button on the hand control to render it fully func-

tional again. The battery pack is charged when it is connected to the mains after every use or if the charge has fallen too low.

NOTE If the bed is stored for a long period without being connected to the mains supply, the battery pack can discharge. The degree of discharge depends on environmental conditions.

To increase the stand-by time, it is recommended to activate the reset button on the housing when storing the bed, to disconnect the bed from the mains. The bed should not be stored for a period longer than 6 months with a fully charged battery pack without recharging it.

NOTE During the charging cycle, the battery pack is connected to the mains supply and is therefore supplied with electricity.

The LED displays the battery pack's charging status during the charging cycle. The current cut-off is deactivated and current flows to the bed when the LED of the mains voltage display is green and the LED of the battery display flashes.



NOTE If the red LED lights up but the bed cannot be electrically adjusted, press the mains isolation switch.



WARNING If electromagnetic interference occurs with other equipment in the area around the bed, please refrain from using these devices.

The bed should always be handled carefully during transport and protected from damp.

Activation | Using the battery pack 2/2 and taking out of service

NOTE The bed is designed for use in an ambient temperature range from 10 °C to 40 °C, with a relative humidity of 30% to 40% and an air pressure of 700 to 1060 hPa.

WARNING The battery pack must only be replaced by personnel trained by Völker GmbH.

WARNING If the battery pack is faulty, degassing can occur. In rare cases, this can cause deformation of the battery pack housing. If this occurs, the bed must be immediately taken out of service and taken to an adequately ventilated room without sparks (from electricity or fire). Immediately inform customer services should this occur!

WARNING The battery pack must be disposed of in an environmentally responsible manner using the appropriate services. Alternatively, you can return it to Völker GmbH for disposal.

To activate the hand control and the nurse keypad (option) once the bed has been activated, the function key lock must be disabled  38.

Taking out of service

The bed is taken out of service by disconnecting it from the mains supply. To do this, the mains plug is disconnected from the mains socket. If the bed is to be out of service for a period longer than two weeks, then the reset button on the engine housing must also be pressed to disconnect the battery pack from the mains.

The reset button must also be pressed when repairs are carried out on the system.

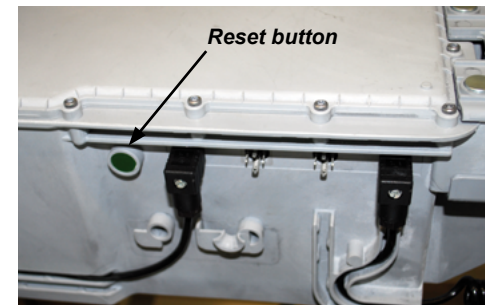

Activation | Functional check

Visual inspection

Before each new occupancy of the bed, the following checks must be carried out:

1. Ensure the bed exhibits no visible signs of damage.
2. Ensure that the insulation of the electrical cables is intact.
3. Ensure that the next testing date has not been missed (see testing label).



WARNING Only undamaged beds that are still within their testing interval periods may be used!

Functional check

A functional check must be carried out before each new occupancy:

1. All electrical functions must be actuated to their terminal positions once.
2. The function of all side rails must be checked.
3. The braking function of the bed must be checked.

Once a fault-free functional check has been carried out, the bed is ready for use.

Operation

The **Operation** section provides you with all the information required to operate the Völker bed.



CONTENTS

Key lock	38
Central castor adjustment	39
Side rails	40
General safety notes	40
Model 2082	41
Models 3082, 3082 K	42
Back section	44
Mechanical rapid lowering of the back section / CPR function (option)	45
Upper and lower leg sections	46
Lying surface height	47
Anti-Trendelenburg and Trendelenburg positioning (option)	48
Comfort seating position (option)	49
Bed extension (option)	50

Operation | Key lock

Activating the hand control key lock disables its functions completely.

The hand control can be locked either on the hand control itself or on the nurse keypad (option).

The locking switch is located on the reverse of the hand control. It is unlocked and locked with the key (open lock visible). The hand control can also be locked with the button "lock hand control" on the nurse keypad.



This lock only affects the hand control.

The nurse keypad must be switched on by pressing the on switch to operate the bed. It locks automatically 120 sec. after the last actuation.

If the bed functions cannot be actuated, check whether the key lock is activated.



Hand control locked



Hand control unlocked

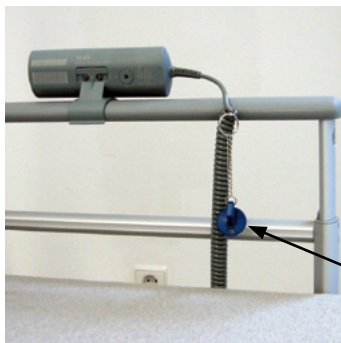

Key

The key should be removed from the bed when it is not required.

Operation | Castors

To move the bed, the castors integrated into the four feet of the bed must be lowered. The lying surface must be in its lowest position before this can be done.





CAUTION "Risk of accident"

If the bed is not being transported, the castors must always be raised, since the bed may be required as a support for when the occupant/patient stands up or lies down. If the bed rolls away while the castors are down, this can lead to a serious fall. Once the castors have been raised, it must be checked that the bed is actually securely parked, i.e. the castors are completely raised.

NOTE The bed is not suitable for transporting the occupant/patient.

Lowering the castors

1. Move the lying surface to its lowest position by pressing the  button.
2. Press the  button while holding the  button down until the lifting device automatically switches off.

The bed is now standing on its four castors and can thus be moved easily.



Raising the castors

1. Press the   button on the height adjustment control.

The castors retract into the pillars of the lower frame so that the bed stands firmly on four floor protection caps.



Operation | Side rails | General safety notes



WARNING All people whose duties involve manoeuvring of the side rails must have read and understood the following information:

- During actuation of the back, upper leg or lower leg section adjustment, of the lift or of the side rails, it must always be ensured that the occupant/patient is not touching the side rails, and that no part of his/her body is sticking out through the side rails.
- If the side rails are used for an individual whose psychological condition necessitates their use, it must be ensured that the hand control is stored completely out of his/her reach or its functions are completely locked. In all cases, care must be taken to ensure that entrapment risks are minimized.
- Protective covers (cot side pads) are available as an accessory for the side rails. These provide additional protection against injury from contact with the side rails. The use of these protective covers is recommended for all persons for whom the risk of injury from unavoidable contact with the side rails is very high. Even with the covers, the care staff or occupant/patient must still take the necessary care when operating the bed.
- If the side rails are used, they must always be either completely raised and securely engaged, or completely lowered to the end stop. Because of the risk of entrapment, they must **never** be left in a position where they are not completely engaged.
- If the side rails are damaged, there is a risk that the patient will fall out of bed.

Operation | Side rails | Model 2082

Raising the side rails

To raise the side rails, take hold of the grip recess and lift it first at the head end and then at the foot end until the rail audibly engages.

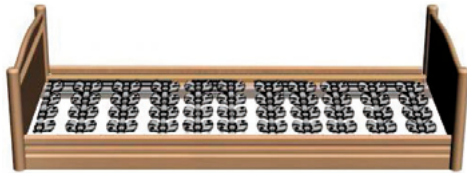

Securing buttons (external)

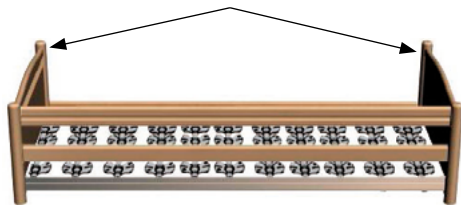

Lowering the side rails

Starting at the foot end, take hold of the recess grip and lift the top rail slightly.

Press the button on the side and allow the side rail to lower. Repeat at the head end.



WARNING

"Risk of entrapment"

On model 2082, the side rails must be either completely raised and securely engaged or be in the fully lowered position.

For safety reasons, the side rails cannot be released when there is pressure being exerted on them from above.

All side rails down: the bed is accessible without restriction from both sides.

All side rails up: the occupant/patient enjoys maximum protection from rolling out of bed.

Operation | Side rails | Models 3082, 3082 K 1/2

Raising the side rails

1. Pull the side rail element out horizontally until the end stop, and fold it upwards.
2. To adjust the height of the side rail, pull the telescopic section upwards until it reaches its end stop.

Lowering the side rails

1. Press both buttons on the outside of the frame, right under the cross-member, to bring the height-adjustable side rail element to its lowest position.



2. Press the trigger labelled "Drücken / Press" at the lower edge of the side rail element and tilt it sideways into the horizontal plane, so that it lies parallel to the floor.

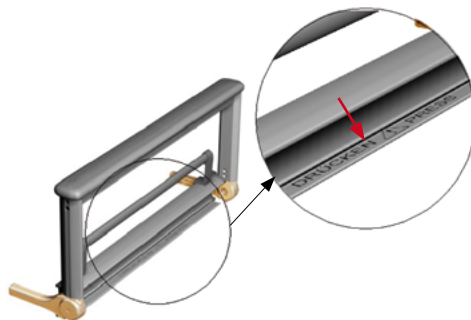

3. Push the rail element completely underneath the lying surface.

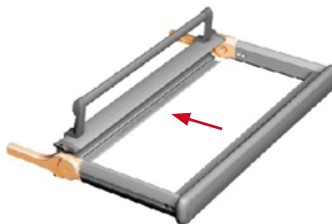

The side rail elements can be used individually or together as required to protect the occupant/patient.

Raising all four rail elements offers the occupant/patient maximum protection.

⚠ WARNING The side rails should always be gripped with two hands at the ends of the element in question and guided upwards or downwards.

⚠ CAUTION Any weight on side rail elements that are pulled out horizontally must not exceed 15 kg!

Operation | Side rails | Models 3082, 3082 K 2/2

NOTE Due to their exceptional stability, the side rail elements can also be used as a surface for storing bed linen (max. 15 kg) or as an additional supporting surface for care-related positions, such as Bobath treatments, or for the delivery of physiotherapy-related treatments.

Operation | Back section

The back lying surface can be adjusted using the hand control or the nurse keypad (option).

If necessary, disable the hand control lock  38.

The back section of the lying surface can be raised up to an angle of max. 70°.



Back section up/down



Back section up/down



WARNING When the back section is being raised with the side rails up, it must be ensured that none of the occupant's/patient's or any other person's body parts are sticking out through the side rails or are on top of them!

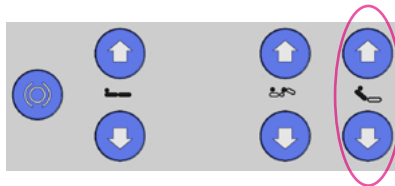

Hand control

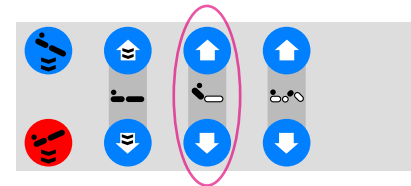

Nurse keypad (option)



WARNING

"Risk of entrapment"

When adjusting the position of the back section, do not touch the frame in the area of the back section!



Operation | Mechanical rapid lowering of the back section / CPR function (option)

The bed can optionally be fitted with a mechanical rapid lowering function of the back section for resuscitation.

 **WARNING** The CPR function (Cardiopulmonary Resuscitation function) may only be operated by qualified personnel!

Hold the back section on the mattress holder, or the corner of the back section for model 2082, and pull the red lever located at the left or right underneath the back section of the lying surface upwards to lower the back section rapidly. The back section can now be moved quickly downwards. The lowering process can be interrupted by letting go of the red lever.

 **WARNING** The back section must always be held on the mattress holder, or on the corner of the back section for model 2082, so that the back section is not lowered suddenly with the occupant/patient.

Yellow lever for mechanical rapid lowering of the back section for resuscitation:



Operation | Upper and lower leg sections

The position of the upper leg lying surface can be adjusted using the hand control or the nurse keypad (option).

If necessary, disable the hand control lock  38.

The upper leg section of the lying surface can be raised up to an angle of max. 45°.

The lower leg section can be moved manually to any position of maximum 45° by pulling on the mattress holder (on the lying surface of model 2082).

To lower the lower leg section, the mattress holder (or the lying surface on model 2082) is pulled and the section lifted to the end stop and then lowered. The locking mechanism is disengaged automatically.



WARNING When the upper or lower leg section is being raised with the side rails up, it must be ensured that none of the occupant's/patient's or any other person's body parts are sticking out through the side rails or are on top of them!



Upper leg section up/down



Upper leg section up/down

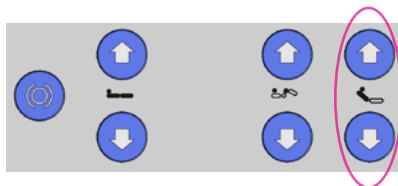

Hand control

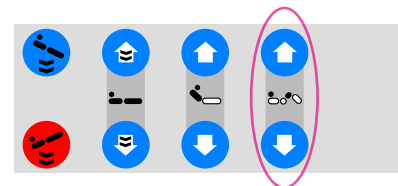

Nurse keypad (option)



WARNING "Risk of entrapment for 3082, 3082 K" When the position of the upper leg section is being adjusted, there is a risk of entrapment between the raised side rail and the foot section.

Operation | Lying surface height

The position of the entire lying surface can be adjusted using the hand control or the nurse keypad (option).

If necessary, disable the hand control lock  38.

The lying surface height can be adjusted from 40 cm to 80 cm (optionally from 35 to 70 cm).



WARNING To avoid dangers to the occupant/patient from falling, we recommend that the bed be lowered all the way except when delivering care!



DANGER Before lowering the bed, it must be ensured that no people, limbs, pets, bed linen or other objects are trapped between the lying surface and the lower frame or floor. The bed's position must be stable (castors raised) when the patient is getting in and out of the bed!

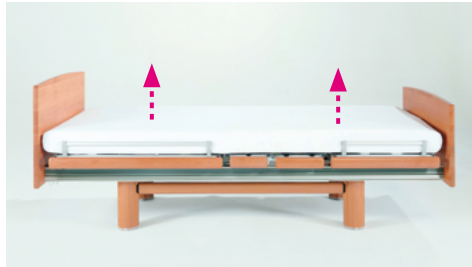

Lying surface up/down

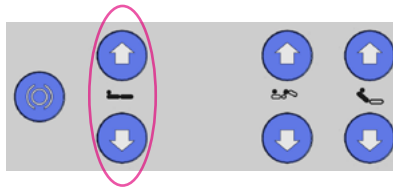

Hand control



WARNING When the height adjustment mechanism is actuated with the side rails up, it must be ensured that the occupant/patient does not have any contact with the side rails, or that any parts of either the patient's body or of other persons are sticking through the side rails!



Lying surface up/down

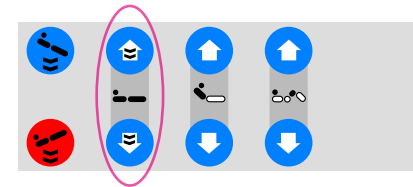

Nurse keypad (option)

Operation | Anti-Trendelenburg¹ and Trendelenburg positioning (option)²

Trendelenburg positioning (option) can only be set using the nurse keypad (option).

If necessary, disable the hand control lock  38.

The Trendelenburg position can be adjusted up to an angle of 12°.



Anti-Trendelenburg positioning ¹



Anti-Trendelenburg positioning ¹
Trendelenburg positioning ²



CAUTION If a fault occurs with the lifting function, or the mains power supply fails and the battery pack is completely discharged, the Trendelenburg function cannot be engaged. The occupant/patient may have to be placed in a different bed!

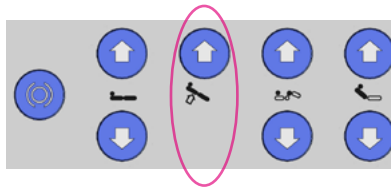

Hand control with Anti-Trendelenburg positioning (option)

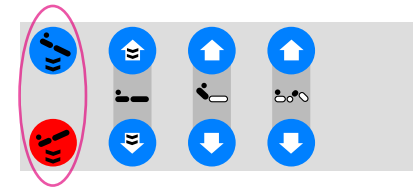

Nurse keypad (option)



WARNING Since the Trendelenburg positioning depends on clinical indications, it must only be used with appropriate clinical approval.

The lying surface is automatically returned to its horizontal position if it is moved to its highest or lowest position.

¹ Head end raised

² Head end lowered

Operation | Comfort seating position (option)



Anti-Trendelenburg positioning



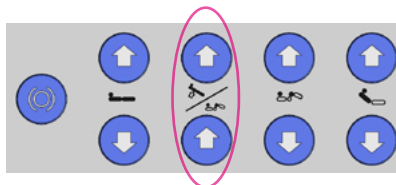

Occupants/patients who are unable to leave the bed either because their circulatory system is too unstable or they first have to be "taught" how to sit can gain a lot of benefit from the comfort seating position as it provides an active sitting position in the bed.





Auto-Contour

Hand control with Anti-Trendelenburg positioning (option) and Auto-Contour (option)

Adjusting the comfort seating position

1. Move the back  and the upper leg section  upwards a little to a comfortable position. Alternatively, you can reach this position in a single step by pressing the Auto-Contour button (option) .
2. Swivel the bed to the comfort seating position by pressing the Anti-Trendelenburg button  (option).

Restoring the straight lying surface

To return to a horizontal lying position, move the lying surface  and the back  and upper leg section  in any preferred order to their lowest position.

Operation | Bed extension (option)

Models 3082, 3082 K

The bed can be extended by 20 cm using a telescopic bed extension (option).

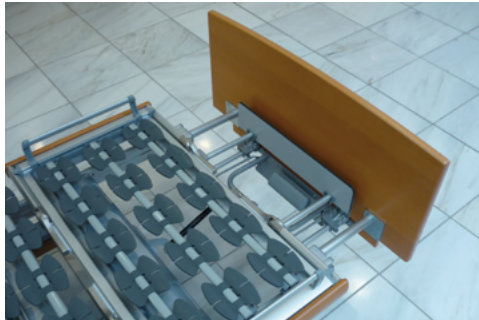

Model 3082

To pull out the bed extension, pull the two pins located on the underside of the bed extension simultaneously downwards.



Model 3082 K

To pull out the bed extension, press the two lever buttons simultaneously downwards.

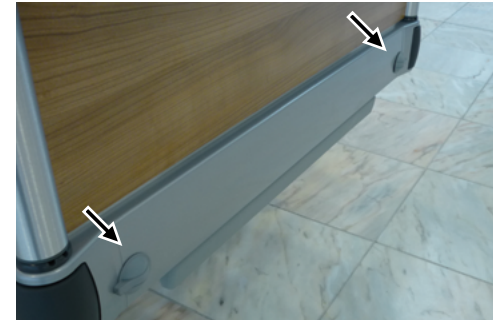

Cleaning and disinfection

This section contains details on the **cleaning and disinfection** of the bed.

CONTENTS

Cleaning	52
Wipe and spray disinfection	52
Spray lances and automatic washing systems	53



Cleaning and disinfection 1/2

In order to maintain consistent functioning, the bed should be cleaned, disinfected and tested as soon as possible following each use, so that it can be reused immediately without risk. Incorrect cleaning/disinfection of the bed can cause danger.

Cleaning

Depending on the degree of soiling, we recommend cleaning the bed with a damp cloth or similar.

Wipe and spray disinfection

For wipe and spray disinfection, the disinfecting agents featured in the VAH (Verband für angewandte Hygiene e.V.) list dated 01.01.2008 can be used in their specified concentrations in Germany. They must be applied at the dilution ratio specified by the relevant manufacturer's instructions for use. The list can be obtained under ISBN Number 978-3-88681-089-5.

NOTE Solvents are not permitted. Scouring agents, abrasive sponges or other blunting agents must not be used. Organic solvents such as halogenated / aromatised hydrocarbons and ketones must not be used.

The following instructions must be noted when using cleaning and disinfecting agents:

- The working solutions should generally be freshly prepared.
- The concentrations used should be neither higher nor lower than those given in the list. The so-called "shot" method should not be used under any circumstances. Under no circumstances should someone using a disinfectant follow their own judgement to add a detergent such as a soap or detergent substance (leads to soap failure).
- There is a risk of fire or explosion from alcoholic spray disinfectants when these are used over large areas.

- They must not contain any corrosive or irritant components.
- They must not contain any substances that change the surface structure or gripping properties of the materials.
- Lubricants must not be affected.
- The pH value of the water must be no higher or lower than 6-8.
- Water should not exceed a total water hardness of 0.9 mmol/l (up to 5 deg d).

Cleaning and disinfection 2/2

The specifications in the VAH list, as well as the specifications we have issued do not absolve the user of the obligation to carry out his or her own checks and investigations, since the ratios (e.g. water hardness) can vary depending on the geographical location. It is therefore impossible to offer legally binding assurance of certain properties.

If unsuitable washing and disinfecting agents are used, if the mixing ratio is incorrect or if there is inadequate care of the beds, damage can occur to the surface coating for which Völker GmbH is not liable.



WARNING

"Risk of electric shock / fire and functional failure"

The bed must always be disconnected from the power supply during cleaning and disinfection.

The plug and the socket of the hand control are only protected against spray when the control is stowed and the appropriate cover is in place.

Spray lances and automatic washing systems

Cleaning and disinfection using spray lances from high-pressure cleaning equipment and in automatic bed washing systems is **not** permissible.

Maintenance

The **Maintenance** section contains information on how to carry out maintenance work.

CONTENTS

Staff training	55
Safety notes	55
Maintenance schedule	56



Staff training

Every person involved with maintenance or servicing must at least

- have been instructed in the use of the service tools by Völker
- have read the safety notes and
- the service manual

and be qualified in accordance with MPBetreibV §§ 4 and 6. To avoid errors and ensure that our beds work properly, these documents must always be accessible to service personnel.

Before commencing maintenance work, the service manual and the instructions for use must be read in full by the person responsible for carrying out the servicing.

Safety notes

During maintenance and technical checks, the following specifications must be strictly observed:

- The room's electrical installations must satisfy current technical requirements and the bed must be used correctly.
- The castors must be placed in the "brake position".
- The beds are not protected against explosion and must therefore only be maintained in an environment free from flammable substances and materials.

 **WARNING** Before carrying out any maintenance work, always disconnect the mains plug **and** disconnect the battery pack from the mains by pressing the green button on the engine housing.



 **WARNING** Maintenance and repair work should only be carried out after the bed has been disinfected.

 **WARNING** After maintenance (repair) work is complete, always check that the bed is functioning correctly. It must be checked that the bed can be used correctly without risk to the occupant/patient or care personnel.

 **WARNING** When working on the open motor, it must be ensured that there is no contact with the power supply board for at least 20 minutes after disconnecting it from the power supply **and** the battery. The reason for this is to allow self-discharge of the 4.7nF smoothing capacitor, which would represent a risk to persons.

 **WARNING** When connecting a motor to the extension board, it must be noted that only 1 motor may be connected.

Maintenance | Maintenance schedule

The bed requires little maintenance. All movable parts for the height adjustment mechanism, the lying surface motor systems and the side rails are provided with long-lasting lubricant at the factory. It is recommended that the bed is subjected to a regular, or at least once a year, **Technical check**  57 **(incl. visual inspection and functional check) as described in the checklist**  83 and any damage uncovered as a result, such as signs of wear and tear, loose screws or breaks/fractures, be eliminated immediately.

After every lengthy period of non-use, a Technical check  57 must be carried out.

Period	Work to be carried out
Annually and after lengthy periods of non-use	Technical check  57
As required	Lubricate mechanical parts Replace parts subject to wear (see service manual)
Every 3-5 years	Replace the battery pack

Technical check

The section entitled **Technical check** contains all the information needed to carry out the technical check in accordance with MPBe-treibV, BGVA3, UVV on hospital and care beds and measurement as per DIN EN 62353 (VDE 0751-1).

Other (e.g. country-specific) specifications have not been included here. This does not absolve the operator from the obligation to observe any such specifications.

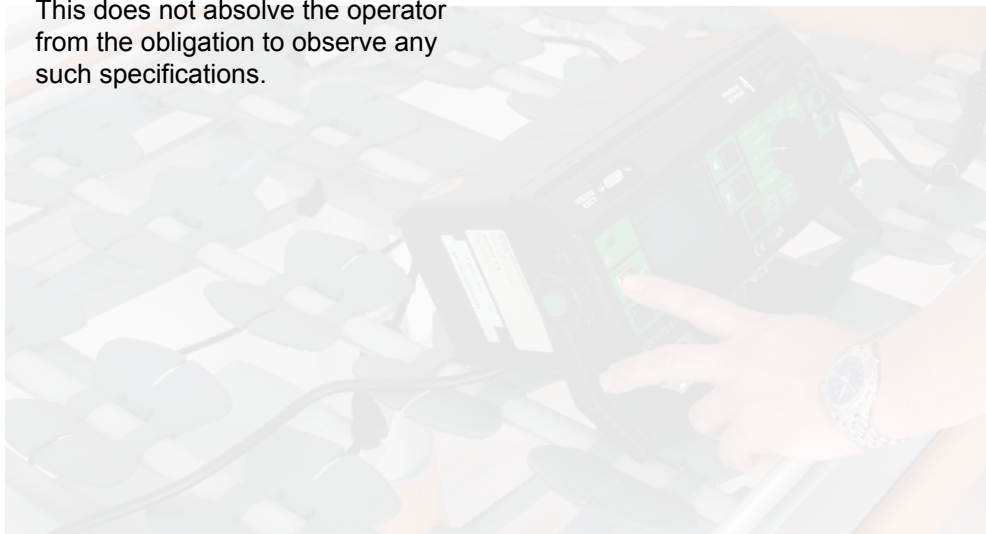

CONTENTS

Visual inspection	58
Functional check of the side rails	58
Functional check of the brakes	60
Functional check of the motors	60
Mains connection cable	60
Cabling	60
Housing	60
Mechanical check	60
Measuring in accordance with DIN EN 62353 (VDE 0751-1)	61
Checking the trapeze bar grab handle	61
Further accessories	61

Technical check 1/4

1. Visual inspection

Check the frame parts for plastic deformations and/or wear and tear. This includes the lower frame, the lifting mechanism, all parts of the lying surface (back, seat, upper leg and lower leg sections, wing and spring elements (if present)), trapeze bar, trapeze bar holder and castors.

2. Functional check of the side rails

The side rails must be checked in accordance with DIN EN 60601-2-38 or IEC/FDIS 60601-2-52. Please see the declaration of conformity supplied with the bed for which of the two standards should be used.

Inspection in accordance with DIN EN 60601-2-38

Check that the locking mechanism for the side rails is working correctly and that there are no visible deformations or signs of wear and tear on the side rails.

Check that the prescribed distances are maintained, even when the side rails are

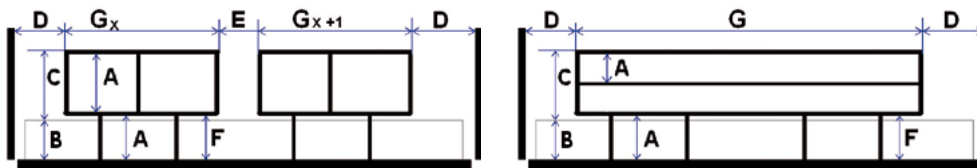

Letter	Description	Dimension
A	The greatest distance between the elements within the scope of the SIDE RAILS in a raised / engaged position or the area formed by the SIDE RAILS and fixed parts of the BED.	≤120 mm
B	Thickness of the mattress for CORRECT USE	defined by the manufacturer
C	Height of the upper edge of the SIDE RAILS over the mattress (see "B") without compression	≥220 mm
D	Distance between the HEAD or FOOT SECTION and the SIDE RAIL	≤60 mm or ≥235 mm
E	Distance between the divided SIDE RAIL with the LYING SURFACE in flat position	≤60 mm or ≥235 mm
F	Distance of all accessible openings between the SIDE RAILS and the LYING SURFACE	if D or E ≥235 mm then F ≤60 mm if D or E ≥60 mm then F ≤120 mm
G	Total length of the SIDE RAIL or sum of the length of the divided SIDE RAILS on one side of the BED	$\sum G_x \geq 1/2$ the length of the LYING SURFACE

Technical check 2/4

placed under load. All measurements of side rail distances must be carried out in the flat lying surface position.

The measurement of A must be performed using a cone as defined in DIN EN 60601-2-38. The force used for measurement A must be at least 50 N.

Inspection in accordance with IEC/FDIS 60601-2-52

Check that the locking mechanism for the side rails is working correctly and that there are no visible deformations or signs of wear and tear on the side rails.

Check that the prescribed distances are maintained, even when the side rails are placed under load. All measurements of the side rail distances should be made in the flat lying surface position, since the dimensions given while the bed is otherwise positioned do not show less favourable conditions.

The measurement of A and D must be performed using a cone as defined in IEC/FDIS 60601-2-52. The force used for measurement A must be at least 250 N.

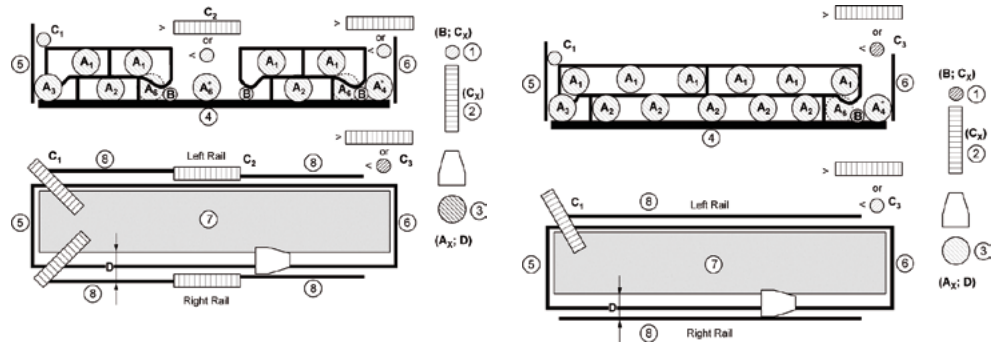

Letter	Description	Dimension
A _x	The distance between elements within the scope of the SIDE RAIL in its raised/engaged position or of the area formed by the SIDE RAILS and the fixed parts of the BED or ACCESSORIES.	< 120 mm
B	Not applicable	-
C ₁	Distance between HEAD SECTION and SIDE RAIL	< 60 mm
C _{2,3}	Distance between divided SIDE RAIL and distance between SIDE RAIL and FOOT SECTION	< 60 mm or > 318 mm
D	Area between SIDE RAIL and MATTRESS	120 mm cone may sink max. 60 mm under the mattress surface without pressure
G	Height of the upper edge of the SIDE RAILS over the mattress over at least 1/2 of the length of the LYING SURFACE	≥ 220 mm

Technical check 3/4

3. Functional check of the brakes

Check the function of the brakes. Raise and lower the castors.

4. Functional check of the motors

Travel through the full adjustment range of each motor. Look out for any unusual noises, watch the speed, ease of running etc., and check that the selected function travels in the correct direction. Particularly ensure that the motor switches off automatically when it reaches its terminal position*.

* Please note that the terminal position can vary from bed model to bed model. Please consult the technical specifications for this, or if in doubt, contact our service department.

5. Mains connection cable

Check

- the mains connection cable, incl. cable guides,
- the strain relief, including kink protection sleeve,
- the mains connection plug for damage.

6. Cabling

Check the cable guides and that the plug connectors are correctly seated and do not exhibit any damage.

Check the cables for damage.

7. Housing

Check all housings for damage. All screws must be firmly tightened and seals must not exhibit any visible damage.

8. Mechanical check

Check the function of the Rastomat by manually moving the lower leg section to the individual positions.

Technical check 4/4

9. Measuring in accordance with DIN EN 62353 (VDE 0751-1)

The bed must be checked electrically in accordance with DIN EN 62353 (VDE 0751-1). The leakage current should be measured by means of alternative measurement.

On beds with a potential cable connection (see sketch below), the impedance of the potential equalisation within the bed must also be measured.

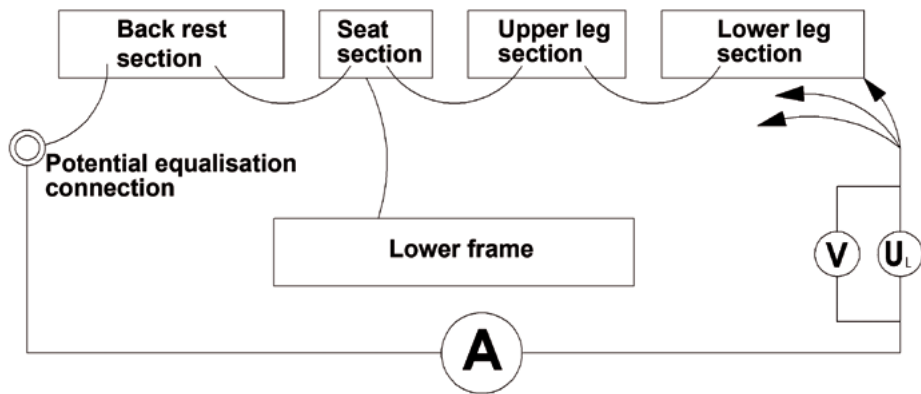

10. Trapeze bar grab handle

Check whether the plastic and holding frame of the grab handle exhibit any damage and that the fixing rods on the trapeze bar are intact.

The handle of the trapeze bar, including the fastening strap, must be replaced in the following cycle:

- Every 5 years: handles and handles with roll function in nursing homes

- Every 3 years: handles with roll function in hospitals

11. Further accessories

Further accessories must always be checked in accordance with the manufacturer's instructions.

Troubleshooting

The section entitled **Troubleshooting** contains a table of faults for users, together with information on the service points.

CONTENTS

Table of faults	63
Service points	66



Troubleshooting | Table of faults 1/3

The following table contains information on possible functional problems that the users can resolve themselves.

Faults that can only be eliminated by technical engineers are described in the service manual.

Anyone responsible for carrying out maintenance and repair work must at least have received instruction from Völker in the service tools, have read the safety notes and the service manual and be qualified in accordance with MPBetreibV §§ 4 and 6.

NOTE Before carrying out any troubleshooting, turn the nurse keypad on and ensure that the battery pack is charged (observe the LED of the battery display on the nurse keypad) and that the bed is connected to the mains supply (the mains plug is in a live socket).



WARNING Before carrying out any repair work, ensure that the bed has been disconnected from the power supply and from the battery pack if present by pressing the reset button.

If the same fault occurs repeatedly, use the diagnosis tool to read out the error memory before resetting the system again.

Troubleshooting | Table of faults 2/3

Fault	Possible cause	Troubleshooting
The bed cannot be adjusted electrically.	(1) The key lock is engaged. (2) The mains plug is not plugged in or there is no power to the socket and battery pack is discharged. (3) Battery pack is disconnected. (4) The hand control is faulty. (5) Nurse keypad (option) faulty.	(1) Deactivate the key lock. (2) Connect the plug or check the socket. (3) Press the green button on the mains isolation switch ¹ and then actuate any function on the hand control. (4) Replace the hand control. (5) Replace nurse keypad (option).
The following faults may be assessed with a nurse keyboard (option):		
(Battery LED lights up red and does not flash after pressing the green button on the mains isolation switch and then actuating any function)	(6) Battery pack faulty. (7) Charging connection faulty.	(6) Replace battery pack. (7) Replace the power supply board.
Battery LED lights up red even though battery pack is not discharged.	(8) Mains isolation switch is not disconnected.	(8) Green reset button on engine housing ² was pressed: If the battery display on the nurse keypad (option) then lights up red, briefly disconnect the mains plug (mains isolation switch must be replaced).

 *Continued on next page*

Troubleshooting | Table of faults 3/3

¹ Green button on the mains isolation switch:

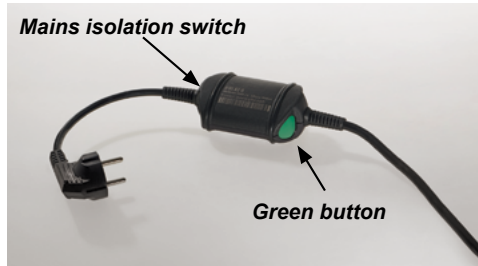

The mains isolation switch ensures that when no electrical function is being actuated, there is no mains voltage to the bed. (Exception: while the battery pack is being charged and when the nurse keypad (option) is activated. This is shown by the LED in the mains voltage display).

² Green reset button on the engine housing:

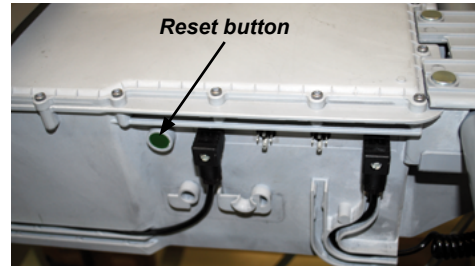

Troubleshooting | Service points

If necessary, please seek assistance from the relevant contact at your nearest Völker sales organisation. You will receive all the information you need for comprehensive service promptly.

The **Appendix** section contains the technical specifications and classifications, details on the service life and disposal of the equipment and links to the manufacturer's declarations and forms found in the appendix.

EU-Richtlinie 93/42/EWG

Der Unterzeichnende
Völker GmbH
Wullener Feld 79
58454 Witten

Mit einer Fertigungsstätte unter der Adresse:
Völker GmbH
Ahornstraße 4
09661 Hainichen

Ich bestätige, dass die nachfolgend bezeichneten Produkte in der von uns in Verkehr gebrachten Ausführung die grundlegenden Anforderungen des Anhangs I der EU-Richtlinie 93/42/EWG erfüllen. Es wurden die folgenden Normen angewendet:

DIN EN 60601-1:2007-07,
DIN EN 60601-1-2:2007-12,
DIN EN 60601-1-4:1996+A1:1999,
DIN EN 60601-2-52:2010-12.

EU Directive 93/42/EEC

The signatory
Völker GmbH
Wullener Feld 79
58454 Witten/Germany

with a manufacturing side at:
Völker GmbH
Ahornstraße 4
09661 Hainichen/Germany

I confirm that the products described below and in the form distributed by ourselves meet the basic requirements of Appendix I of EU Directive 93/42/EEC. The following standards are applied:

DIN EN 60601-1:2007-07,
DIN EN 60601-1-2:2007-12,
DIN EN 60601-1-4:1996+A1:1999,
DIN EN 60601-2-52:2010-12.

The requirements of the medical products

Directive E.U. 93/42/CEE

La soussignée
Völker GmbH
Wullener Feld 79
58454 Witten/Allemagne

avec un site de production à:
Völker GmbH
Ahornstraße 4
09661 Hainichen/Allemagne

Je confirme que les produits spécifiés ci-dessous sont conformes, dans le modèle mis en circulation, aux exigences fondamentales de L'annexe I de la directive européenne 93/42/CEE. Les standards suivants sont appliqués:

DIN EN 60601-1:2007-07,
DIN EN 60601-1-2:2007-12,
DIN EN 60601-1-4:1996+A1:1999,
DIN EN 60601-2-52:2010-12.

Les exigences des produits médicaux

CONTENTS

Symbols used	68
Technical data	69
Classification	71
Type label	72
Service life/disposal	74
Manufacturer's declarations, forms, electronic instructions for use	75

Appendix | Symbols used



Warning symbols

Information marked with this symbol must always be read and strictly observed!



Warning about the risk of crushing and entrapment!



Note the information in the instructions for use!



= 250 kg

Safe working load 250 kg



= 220 kg

Max. permissible weight of the occupant/patient 220 kg (approx. 30 kg for the mattress, trapeze bar and accessories)



Direct current



Alternating current



Protection class II device, protection-insulated



Type B device as per DIN EN 60601-1



The product satisfies the fundamental requirements of Appendix 1 of EU Directive 93/42/EEC.



The product must be disposed of in accordance with EU Directive 2002/96/EC pertaining to old electrical and electronic equipment.

Appendix | Technical data (standard design) 1/2

The details marked below with * are dependent on the length, width or model of the bed. The values specified relate to model 3082 S.



External dimensions (W x L)	
for lying surface 90 x 200 cm *	approx. 98 x 210 cm
for lying surface 90 x 210 cm *	approx. 98 x 219 cm
for lying surface 90 x 220 cm *	approx. 98 x 229 cm
for lying surface 100 x 200 cm *	approx. 109 x 210 cm
for lying surface 100 x 210 cm *	approx. 109 x 219 cm
for lying surface 100 x 220 cm *	approx. 109 x 229 cm
Clearance height	approx. 17 cm
Height of the lower edge of lying surface frame (min./max.)	approx. 27 cm / 67 cm
Height of the upper edge of the lying surface (min./max.)*	approx. 40 cm / 80 cm
Height of upper edge of head and foot section (min./max.)*	approx. 76 cm / 116 cm
Lying surface (4-part) *	90 x 200/210/220 cm 100 x 200/210/220 cm
Volumetric weight of the mattress material	40 - 50 kg/m ³

Unladen weight *	approx. 108 kg
Safe working load for the bed	250 kg As a result of the weight (approx. 30 kg) of the mattress, trapeze bar and other accessories, the maximum permissible weight of the occupant/patient is 220 kg. If another mattress is used or other accessories, this value must be recalculated!
Safe working load for the trapeze bar holder	75 kg
Safe working load for drip stands	2 kg / hook
Rolling castors	4 pcs., Type: K-100/2x1, Halver castors or Blicke castors
Max. load on castors *	100 kg (dynamic)
Mains voltage	AC 230 V (EU version) AC 240 V (UK version) AC 115 V (US version)
Rated power	300 VA
Rated frequency	50 Hz (EU-, UK version) 60 Hz (US version)

Appendix | Technical data (standard design) 2/2

Primary fuse	3.15 A (EU version) 5.0 A (UK version) 6.3 A (US version)
Battery pack	Type: 2 x 12 V block battery (lead gel) 7.2 Ah
Operating temperature range	+ 10 °C to + 40 °C
Transport / storage temperature range	– 20 °C to + 60 °C
Air humidity	30 % to 75 % rel.
Atmosphere range	700 hPa to 1060 hPa
Operating volume	55db(A)

Appendix | Classification

Protection against electric shock	Protection class II or device with internal electrical current source 
Protection type by housing as per EN 60529	IPX4 not suitable for cleaning in automatic washing systems
Degree of protection of the applied part against electric shock as per DIN EN 60601-1	Type B 
Degree of protection against explosive substances and mixtures	The bed is not protected against explosion and should not be used in an environment in which flammable anaesthetics or flammable cleaning agents are present (see brochure from accident prevention organisation ZH 1/200)
MPG grouping	Class I
Mode of operation	Int. 4 min. / 10 min. On-time max. 4 min. Off-time 10 min.
Technical check	1x yearly

Appendix | Type label 1/2

Type specifications

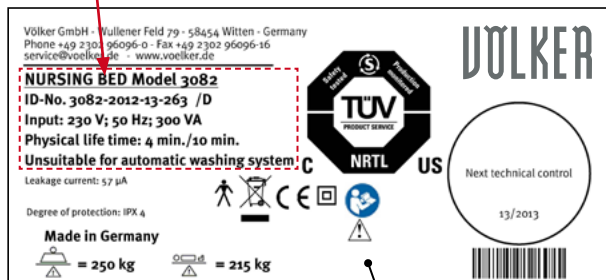

The type label is located on the inside of the head panel.

Raise the back section to read the type label.



Type specifications	Declaration
1st line	Model designation. In the example: NURSING BED model 3082
2nd line	ID No. (made up as follows): 3082 = Model -2012 = Year of construction -13 = Production week (calendar week) -263 = Consecutive number D = Mains plug version (e.g. D = Germany)
3rd line	Input: mains voltage; mains frequency; consumed power
4th line	Physical life time: max. uninterrupted on-time of electric motor adjustment. In the example: 4 min./10 min. In other words, the bed may be operated with the electric motors for max. 4 minutes within a 10-minute period (protection against overheating).
5th line	Save working load (accessories, mattress and weight of occupant/patient).
6th line	Suitability for automatic washing systems. In the example: unsuitable for automatic washing system.

Appendix | Type label 2/2

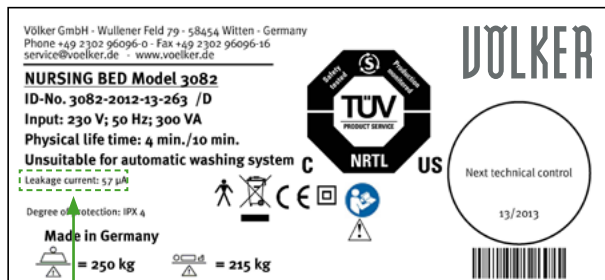

Measured values

Barcode

Measured values

Declaration

1st line

Equivalent unit current leakage in µA

The specified initial measured values were measured in accordance with EN 62353 (VDE 0751-1).

The barcode (code 39) contains the numeric ID No. (10 digits).

Appendix | Service life / disposal

The bed's expected service life is approx. 10 years. To ensure environmentally responsible disposal after decommissioning, please contact your responsible area sales manager.

Appendix | Manufacturer's declarations, forms, electronic instructions for use

Manufacturer's declarations	Forms	Electronic instructions for use	
• Declaration of conformity	76	• Requirement for the use of the electronic instructions for use	85
• Table 201 – Guidelines and manufacturer's declaration – Electromagnetic compatibility (6.8.3.201 a) 3))	77		
• Guidelines and manufacturer's declaration – Electromagnetic compatibility (6.8.3.201 a) 6))	78		
• Table 204 – Guidelines and manufacturer's declaration – Electromagnetic compatibility for all devices and systems that are <u>not</u> life-sustaining (6.8.3.201 b))	80		
• Table 206 - Recommended protected distance between portable and mobile HF telecommunications equipment and the bed – for devices and systems that are <u>not</u> life-sustaining (6.8.3.201 b))	82		
		• Spare part order form	84
			83

Konformitätserklärung / Declaration of Conformity / Déclaration de conformité

<p>Konformitätserklärung Anhang VII EU-Richtlinie 93/42/EWG</p> <p>Der Unterzeichnende Völker GmbH Wüllener Feld 79 58454 Witten</p> <p>mit einer Fertigungsstätte unter der Adresse: Völker GmbH Ahornstraße 4 09661 Heinicchen</p> <p>bestätigt, dass die nachfolgend bezeichneten Produkte in der von uns in Verkehr gebrachten Ausführung die grundlegenden Anforderungen des Anhangs I der EU-Richtlinie 93/42/EWG erfüllen. Es wurden die folgenden Normen angewendet:</p> <p>DIN EN 60601-1:2007-07, DIN EN 60601-1-2:2007-12, DIN EN 60601-1-4:1996+A1:1999, DIN EN 60601-2-52:2010-12.</p> <p>Damit sind die Anforderungen des Medizinproduktegesetzes zur Anbringung einer CE Kennzeichnung erfüllt.</p> <p>Bei einer nicht mit dem Hersteller abgestimmten Änderung des Produktes gültig diese Konformitätserklärung Ihre Gültigkeit.</p> <p>Bezeichnung der Produkte: 3082 Vis-a-Vis, 3082 K Vis-a-Vis, Belleto 3082 Vis-a-Vis, S 282, S 382, S 382 Vis-a-Vis.</p> <p>EG-Richtlinien: Richtlinie 93/42/EWG vom 14.06.1993 über Medizinprodukte (Anhang I „Grundlegende Anforderungen“). Die Produkte sind Produkte der Klasse I gemäß Anhang IX der Richtlinie 93/42/EWG vom 05.09.2007.</p>	<p>Declaration of conformity Appendix VII EU Directive 93/42/EEC</p> <p>The signatory Völker GmbH Wüllener Feld 79 58454 Witten/Germany</p> <p>with a manufacturing site at: Völker GmbH Ahornstraße 4 09661 Heinicchen/Germany</p> <p>confirms that the products described below and in the form distributed by ourselves meet the basic requirements of Appendix I of EU Directive 93/42/EEC. The following standards are applied:</p> <p>DIN EN 60601-1:2007-07, DIN EN 60601-1-2:2007-12, DIN EN 60601-1-4:1996+A1:1999, DIN EN 60601-2-52:2010-12.</p> <p>The requirements of the medical products law pertaining to the display of a CE seal of approval are thereby fulfilled.</p> <p>This declaration of conformity becomes invalid if the products are altered without the agreement of the manufacturer.</p> <p>Description of products Type/Article No.: 3082 Vis-a-Vis, 3082 K Vis-a-Vis, Belleto 3082 Vis-a-Vis, S 282, S 382, S 382 Vis-a-Vis.</p> <p>EU Directives: Directive 93/42/EEC of 14.06.1993 concerning medical products (Appendix I, Basic requirements). The design and construction of this product conforms to Class I (Appendix IX) Directive 93/42/EEC of 05.09.2007.</p>	<p>Déclaration de conformité Annexe VII Directive EU 93/42/CEE</p> <p>La soussignée Völker GmbH Wüllener Feld 79 58454 Witten/Allemagne</p> <p>avec un site de production à: Völker GmbH Ahornstraße 4 09661 Heinicchen/Allemagne</p> <p>confirme que les produits spécifiés ci-dessous sont conformes, dans le modèle mis en circulation, aux exigences fondamentales de l'annexe I de la directive européenne 93/42/CEE. Les standards suivants sont appliqués:</p> <p>DIN EN 60601-1:2007-07, DIN EN 60601-1-2:2007-12, DIN EN 60601-1-4:1996+A1:1999, DIN EN 60601-2-52:2010-12.</p> <p>Les exigences de la loi sur les produits médicaux concernant l'apposition de la marque CE sont ainsi satisfaites.</p> <p>Cette déclaration de conformité est invalidée en cas de modification des produits, non autorisée par le fabricant.</p> <p>Désignation des produits Modèle/Référence: 3082 Vis-a-Vis, 3082 K Vis-a-Vis, Belleto 3082 Vis-a-Vis, S 282, S 382, S 382 Vis-a-Vis.</p> <p>Directives européennes: Directive 93/42/CEE du 14.06.1993 sur les produits médicaux (annexe I « Exigences fondamentales »). La conception du produit est conforme à la classe I (annexe IX) Directive 93/42/CEE du 05.09.2007.</p>
---	--	--

Witten, 20.02.2012



Mitchell Tidman
Geschäftsführer / Managing Director / Gérant

Info: You can find a printable version of this document on the Internet at www.voelker.de.

Table 201 - Guidelines and manufacturer's declaration - Electromagnetic compatibility**(6.8.3.201 a) 3))**

The bed is intended for use in the electromagnetic environment as described below. The customer or user of the bed should ensure that it is used in such an environment.

Emissions measurements	Conformity	Electromagnetic environment - guideline
HF emissions IEC 61000-3-2	Class A	The bed is suitable for use in all institutions, including residential areas and such that are directly connected to a public mains supply network that also supplies buildings intended for residential purposes.
Fluctuations in voltage / flicker IEC 61000-3-3	Conforms	
RF emissions CISPR 14 – 1	Conforms	The bed is not suitable for connection to other equipment.

**Guidelines and manufacturer's declaration - Electromagnetic compatibility
(6.8.3.201 a) 6)**

The bed is intended for use in the electromagnetic environment as described below. The customer or user of the bed should ensure that it is used in such an environment.

Compatibility check	IEC 60601 Testing level	Conformity level	Electromagnetic environment - guideline
Discharge of static electricity (ESD) IEC 61000-4-2	± 6 kV contact discharge ± 8 kV air discharge	± 6 kV contact discharge ± 8 kV air discharge	The ground should be made of wood or concrete and be laid with ceramic tiles. If the ground is covered with synthetic material, the relative air humidity must be at least 30%.
Rapid transient electrical disturbance / bursts IEC 61000-4-4	± 2 kV for voltage supply ± 1 kV for input and output cables	± 2 kV for voltage supply Not applicable	The quality of the voltage supply should be commensurate with a typical commercial or hospital environment.
Surge voltages IEC 61000-4-5	± 1 kV series mode voltage ± 2 kV common-mode voltage	± 1 kV series mode voltage Not applicable	The quality of the voltage supply should be commensurate with a typical commercial or hospital environment.

 *Continued on next page*

Compatibility check	IEC 60601 Testing level	Conformity level	Electromagnetic environment - guideline
Voltage drops, short interruptions and voltage fluctuations in the mains voltage supply IEC 61000-4-11	$< 5 \% U_T$ (>95 % voltage peaks in U_T) for 0.5 cycles $40 \% U_T$ (60 % dip in U_T) for 5 cycles $70 \% U_T$ (30 % dip in U_T) for 25 cycles $< 5 \% U_T$ (>95 % dip in U_T) for 5 sec	$< 5 \% U_T$ (>95 % voltage peaks in U_T) for 0.5 cycles $40 \% U_T$ (60 % dip in U_T) for 5 cycles $70 \% U_T$ (30 % dip in U_T) for 25 cycles $< 5 \% U_T$ (>95 % dip in U_T) for 5 sec	The quality of the voltage supply should be commensurate with a typical commercial or hospital environment. If the user requires continued function from the bed when interruptions in the power supply occur, it is recommended that the bed is powered via an uninterruptible power supply or a battery.
Magnetic field at supply frequency (50/60 Hz) IEC 61000-4-8	3 A/m	3 A/m	Magnetic fields at mains frequency should correspond to the typical values present in commercial and hospital environments.
Remark 1: U_T is the mains AC voltage before the testing level is applied.			

Table 204 – Guidelines and manufacturer's declaration – Electromagnetic compatibility for all devices and systems that are not life-sustaining (6.8.3.201 b))

The bed is intended for use in the electromagnetic environment as described below. The customer or user of the bed should ensure that it is used in such an environment.

Compatibility check	IEC 60601 Testing level	Conformity level	Electromagnetic environment - guideline
Conducted HF disturbances IEC 61000-4-6	3 Vrms 150 kHz to 80 MHz	3 V	Portable and mobile radio equipment should not be used any closer to the bed, or its cables, than the recommended protective distance which is calculated based on the equation applicable for the transmission frequency. Recommended protective distance $d = 1.17\sqrt{P}$ $d = 1.17\sqrt{P}$ 80 MHz to 800 MHz $d = 2.33\sqrt{P}$ 800 MHz to 2.5 GHz

 Continued on next page

Compatibility check	IEC 60601 Testing level	Conformity level	Electromagnetic environment - guideline
Radiated HF disturbances IEC 61000-4-3	3 V/m 80 MHz to 2.5 GHz	3 V/m	<p>Where P is the rated output of the transmitter in Watts (W) as specified by the transmitter manufacturer and d is the recommended protective distance in metres (m).</p> <p>The field strength of stationary radio transmitters should be less than the conformity level^b at all frequencies, as verified by an on-site test^a.</p> <p>Disturbance is possible in the environment of equipment that bears the following label.</p> 

Remark 1: At 80 MHz and 800 MHz, the higher frequency range applies.

Remark 2: These guidelines may not be applicable in all cases. The spread of electromagnetic parameters is influenced by the absorption and reflection of buildings, objects and people.

^a The field strength of stationary transmitters, such as base stations of cordless telephones and mobile land radio, amateur radio stations, AM and FM radio and TV stations cannot be quantified in theory in advance accurately. To determine the electromagnetic environment in relation to a stationary transmitter, a study of the site should be considered. If the measured field strength at the site where the bed is used exceeds the conformity levels stated above, the bed should be observed to ensure that it functions correctly. If unusual features are observed, additional measures may be required, such as modified alignment or a different location for the bed.

^b In the frequency range from 150 kHz to 80 MHz, the field strength should be less than 3 V/m.

Table 206 - Recommended protective distance between portable and mobile HF telecommunications equipment and the bed – for devices and systems that are not life-sustaining (6.8.3.201 b))

The bed is intended for operation in an electromagnetic environment in which HF disturbances are controlled. The customer or user of the bed can help to avoid electromagnetic disturbances by respecting the minimum distance between portable and mobile HF telecommunications equipment (transmitters) and the bed. The recommended minimum distance d is dependent on the maximum power output of the communication device (see below).

Rate output of the transmitter W	Protective distance according to the frequency of the transmitter m		
	150 kHz to 80 MHz $d = 1.17\sqrt{P}$	80 MHz to 800 MHz $d = 1.17\sqrt{P}$	800 MHz to 2.5 GHz $d = 2.33\sqrt{P}$
0.01	0.12	0.12	0.23
0.1	0.37	0.37	0.74
1	1.17	1.17	2.33
10	3.69	3.69	7.38
100	11.67	11.67	23.33

For transmitters whose maximum rated output is not specified in the table above, the recommended protective distance d in metres (m) can be calculated using the equation in the column that features P as the maximum power output of the transmitter in Watts (W) as defined by the transmitter manufacturer.

Remark 1: At 80 MHz and 800 MHz, the higher frequency range applies.

Remark 2: These guidelines may not be applicable in all cases. The spread of electromagnetic parameters is influenced by the absorption and reflection of buildings, objects and people.

Project, address, customer no.:	Name of technician:				
Type of bed, product, location of the bed:	Component to be checked	Actually	Accepted	Not accepted	Not applicable
Bed identification (e.g. facilities own identification or Völker ID no.):	Inscription on device readable				
Date of check:	Instructions for use available				
Kind of check Visual inspection	Base frame	B*			
	Lying surface, wing and spring elements (if existing)	B*			
	Trapeze bar adapter, inflation bar adapter	B*			
	Power supply cable, plug or charger, charging connection	B*			
	Strain relief, bend protection, cable hook	B*/S*			
	Connecting cable, plug-in contacts, blind plugs	B*/S*			
	Positioning (topping 1 mm) and sensor cabling (only Vis-a-Vis-bed)	B*/S*			
	Housing (motor, control electronics)	B*			
	Hand control (housing, cable)	B*			
	Nurse keypad, nurse hand control (housing, cable)	B*			
	Trapeze bar, assist rail infill panel (side rail centre), additional accessories	B*/F*			
	Transverse motors and cover, head and foot ends	B*			
	Castors	B*			
	Wall buffer wheels (if existing)	B*			
	Side rails including telescopic section, if applicable	B*			
	Hi-low-elevation check screw locking (only for S380)	S*			
	Functional inspection of side rails including telescopic section, if applicable	Locking devices	X*		
Deformation		X*			
Abrazats		X*			
Back section, upper leg section, lower leg section, height adjustment, Trendelenburg position, height adjustment, length adjustment (only for Vis-a-Vis-bed) - approach all end positions		X*/M*			
Angle limitation (back section to upper leg section >90°)		X*			
Adjustment lower leg section (ratiomath/hydroflit/support plate)		X*			
CPR function (if existing)		X*			
Brake (electrical or mechanical)		X*			
(only for hospital beds and - sitting position S 280/S 310/S 330/S 262/S 302 (Vis-a-Vis))					
Mechanical release (only for electrical brakes of hospital beds)		X*			
Functional inspection replacement	9 V battery (only for beds with Ok-tiltomat except S 980-1/WS 981)	A2*			
	Replaced (yes/no)				
	Trapeze bar handle and belt (if existing)	A*			
Functional inspection miscellaneous	Replaced (yes/no)				
	Bed extension (if existing)	B*			
	Bedding storage/beading drawer (if existing)	B*			
Comment	Inspection of the adhesive joints on headboard and footboard (if existing)	B*			
Leakage current by means of alternative measurement 5.00 µA (if accordance to DIN EN 62325)	Measuring instrument S/N				
	Leakage current by means of alternative measurement 5.00 µA			µA	
	Potential equalization impedance (-0.2 Ohm (if existing))			Ω	
Total result of the inspection:	Signature of technician:	Need regular inspection:			

A*: To be replaced every 5 years for handles (H) and for H with rail function (RF) in nursing home mode every 3 years for H with RF in hospital mode, every 2 years for H with RF for cleaning in automatic bed washing systems A2*: to be replaced every two years B*: Check for damage F*: Check for deformation M*: Check function of motors and end switches, does the motor switch off when reaching the end position? S*: Check for correct fit X*: General function control

Info: You can find a printable version of this document on the Internet at www.voelker.de.

Spare Part Order/Repair Order

Spare part order

Repair order

Völker GmbH
Service
Wullener Feld 79
58454 Witten/Germany



Address: _____

Contact person: _____

Street address: _____

Zip code/city/country: _____

Telephone number: _____

Customer number: _____

Customer order number: _____

Purchase order date: _____

Signature: _____

(Please, to fill in the form use block letters)

Tel.: +49 2302 96096-0

Fax: +49 2302 96096-66

E-Mail: service@voelker.de

Shipping address, if differently from the billing address

Address: _____

Street address: _____

Zip code/city/country: _____

Attention of: _____

Stamp



Please, fill out all information carefully and complete in the form, otherwise we have problems in delivery and processing this order.

MODEL <small>(Bed-type)</small>	SERIAL NO./YEAR OF MANUFACTURE <small>(Identification label inside of the bed-head)</small>	SPARE PART DESCRIPTION/ERROR DESCRIPTION	ITEM NUMBER	QUANTITY	LOCATION OF THE BED <small>(only for repair order)</small>

Contact person / telephone number for repair orders: _____

(Please, to fill in the form use block letters)

0009-04x27 07 2017

The Völker GmbH inform you, that within the warranty period damages on the devices will be charged by us, if we detect non-intended use.

Info: You can find a printable version of this document on the Internet at www.voelker.de.

Requirement for using the electronic instructions for use

In order to open the electronic version of these operating instructions (PDF file), you must have Adobe Reader 7.0.5 or later (or the corresponding Adobe Acrobat version) installed on your PC.

Adobe Reader is available for nearly all operating systems. The newest version can be obtained free of charge by download from www.adobe.de/products/acrobat/readstep2.html  .

The electronic version of these instructions for use may be found on the Internet at www.voelker.de.

Trademarks

Adobe, Acrobat and Reader are protected or registered trademarks of Adobe Systems Incorporated.

Windows is a registered trademark of the Microsoft Corporation.

Notices:

VÖLKER

Völker GmbH

Wullener Feld 79 · D-58454 Witten/Germany

Phone +49 2302 960 96-0 · Fax +49 2302 960 96-16

www.voelker.de · info@voelker.de