

VÖLKER



Instructions for use
Model S 582

Help

Hyperlinks

Hyperlinks are cross-references in the text. They are marked with the  symbol. The entries in the Table of contents also have hyperlink functionality.

- Clicking on  takes you to the relevant page.

Full-text search for a term

- You can search for any term in this PDF document or optionally in all saved PDF files and/or those that are accessible on your computer using the search function.

Other interactive functions

Programs for viewing PDF files offer the experienced user a whole range of very useful functions for working interactively with documents. You can find further information in the corresponding user manuals or online resources.

Display table of contents



Jump to Help page (this page)



Version, Imprint, Type label

Instructions for use G140

Rev. 2 - 03.2018

for Völker bed model S 582

from year of construction February 2013

© by Völker GmbH 2013

Völker GmbH
Wullener Feld 79
58454 Witten

GERMANY

Tel.: +49 2302 96096-0
Fax: +49 2302 96096-16
e-mail: info@voelker.de
Internet: www.voelker.de

All rights reserved. Reproduction - even in part - is not permitted.

We reserve the right to make changes to reflect technical advances.

The contents of this document are subject to change without prior notification.

Customers are advised to contact the responsible area sales manager before placing an order.

Type label

Völker GmbH - Wullener Feld 79 - 58454 Witten - Germany
Phone +49 2302 96096-0 - Fax +49 2302 96096-16
service@voelker.de - www.voelker.de

Hospital low height bed Model S 582
ID-Nr. 582-2013-19-210 /D DAo2
Input: 230 V; 50/60 Hz; 210 W
Operating time: 16% (2 min./10 min.)
Not for automatic washing system!
Leakage current: 26,3 µA
Impedance: 0,03 Ohm
Degree of protection: IPX4
Made in Germany

TÜV SÜD
Production monitored
Safety tested

Next technical control
4/2014

= 250 kg = 185 kg CE

The type label is located at the head end on the inside of the frame.

Raise the back section to read the type label.

For further information on the type label, see Appendix 72.

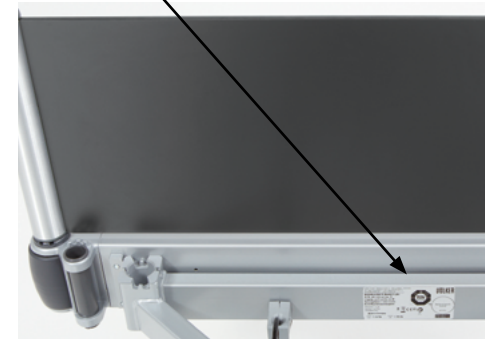













Table of contents 1/2

| | | | | | |
|---|----|--|----|--|----|
| Help | 2 | Nurse keypad with individual lock / automatic functions (optional) | 25 | Anti-Trendelenburg- and Trendelenburg position | 48 |
| Version, Imprint, Type label | 3 | | | Comfort seating position | 49 |
| Table of contents | 4 | Trapeze bar and accessory holders | 26 | Bed extension (optional) | 50 |
| Foreword | 6 | Versions and options | 27 | Cleaning and disinfection | 51 |
| Notes | 7 | Accessories | 29 | Cleaning | 52 |
| General information | 8 | Activation | 31 | Wipe and spray disinfection | 52 |
| Designated purpose | 9 | General operating instructions | 32 | Spray lances and automatic washing systems | 53 |
| General regulations, training/ instruction of users, further requirements | 11 | Preparation | 33 | Maintenance | 54 |
| General safety notes | 12 | Electrical activation | 34 | Staff training | 55 |
| Functional description | 17 | Using the battery pack | 35 | Safety notes | 55 |
| Overview | 18 | Taking out of service | 36 | Maintenance schedule | 56 |
| Hand control with hook | 19 | Functional check | 37 | Technical control | 57 |
| Transverse hand control (optional) | 20 | Operation | 38 | Visual inspection | 58 |
| Nurse hand control / nurse keypad | 21 | Key lock | 39 | Functional check of the side rails | 58 |
| Nurse hand control with total lock-out (Easy-Lock) | 22 | Castor fixing | 40 | Functional check of the brakes | 59 |
| Nurse hand control with total lock-out (optional) | 23 | Side rails | 41 | Functional check of the drives | 59 |
| Nurse keypad with individual lock (optional) | 24 | General safety notes | 41 | Mains connection cable | 59 |
| | | Side rails | 42 | Cabling | 59 |
| | | Back section | 44 | Housing | 59 |
| | | Mechanical rapid lowering of the back section / CPR function | 45 | Mechanical check | 59 |
| | | Upper and lower leg sections | 46 | Measurement in accordance with DIN EN 62353 | 60 |
| | | Lying surface height | 47 | | |

Table of contents 2/2

| | |
|---|--|
| Checking the trapeze bar grab handle |  60 |
| Further accessories |  60 |

| | |
|------------------------|--|
| Troubleshooting |  61 |
| Table of faults |  62 |
| Service points |  66 |

| | |
|---|--|
| Appendix |  67 |
| Symbols used |  68 |
| Technical data |  69 |
| Classification |  71 |
| Type label |  72 |
| Service life / disposal |  74 |
| Manufacturer's declarations, forms, electronic instructions for use |  75 |

Foreword

We are delighted that you have chosen Völker beds.

We are also grateful for the trust you have placed in our company and our products.

This step is undoubtedly the result of extensive considerations and examinations of the requirements that you put on new care or hospital beds based on your previous experiences.

You clearly had good reasons to choose Völker care beds.

We promise you that Völker beds won't disappoint you.

Völker beds do not enjoy a worldwide reputation as particularly innovative medical aids without good reason. This refers not only to the design principle, which was completely redeveloped by Völker. It also refers to the multitude of product advantages which were continually tested and improved for their practicality. These will support the comfort of the patient and also help to reduce the load of daily care work.

Völker beds not only look great, but they also offer functions that can be controlled or adjusted mechanically, although most of them are controlled or

adjusted using electric motors or electronic components.

If you purchase these beds, the responsibility for their correct and appropriate use is transferred to you. Consequently, we strongly advise that you consult the enclosed instructions for use to learn about the technical features, handling and use of all the functions.

We wish you every success with Völker beds,

Yours Völker GmbH

Notes

The **Notes** section contains information on the designated purpose of the product, as well as general safety notes.

CONTENTS

| | |
|---|----|
| General information | 8 |
| Designated purpose | 9 |
| General regulations, training/ instruction of users, further requirements | 11 |
| General safety notes | 12 |

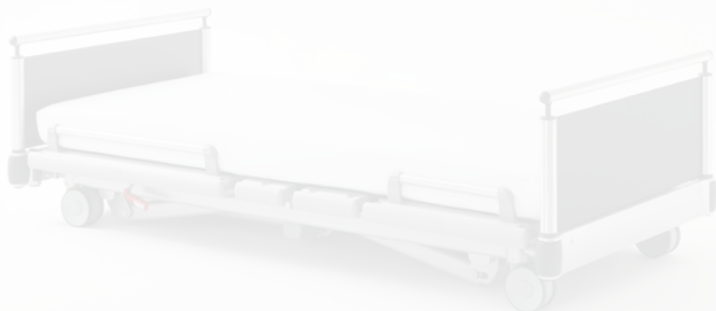

Notes | General information

General notes

You have purchased a bed from Völker GmbH. This bed has been built in accordance with the applicable national and international standards and regulations reflecting the current state of technology.

Völker beds satisfy requirements in terms of safety and functionality. They are tested in accordance with international standards and bear the CE mark, which documents the beds' compliance with essential requirements for medical products.

Please read the general safety notes  12. Please also observe (with particular attention to any warranty claims) the further notes on the following pages.

Standard design

The standard design of the bed can be supplied with various options. A description of these options can be found in the section entitled "Versions and options"  27.

Copyright protection

These instructions for use may only be transferred to third parties with the written consent of Völker GmbH. All documents are protected under copyright.

Guarantee and liability

Völker GmbH is liable for any faults or failures, not including further claims arising in the context of the warranty obligations detailed in the main agreement. Claims for compensation, for whatever legal reason such claims may be raised, will not be entertained.

We reserve the right to make technical modifications without notice as part of the further development of the beds which form the subject of these instructions for use. All specifications are non binding. Printing errors excepted.

We accept no liability for damage and operational faults caused as a result of misuse and/or non-observance of these instructions for use.

The portrayal of the accessories does not necessarily match the actual product.

Notes | Designated purpose 1/2

Intended Use

Völker bed model S 582 is a bed for medical use and is intended for use by patients in wards of hospitals, clinics and care institutions.

The bed is intended for use by people over the age of 12 or who are taller than 146 cm.

The safe working load of the bed is 250 kg. For calculation of the maximum patient weight, 20 kg for the weight of the mattress and 45 kg for the accessories as well as the load that is borne by the accessories must be subtracted from the safe working load according to DIN EN 60601-2-52:2010 when using the bed in application environments 1 and 2 (intensive and acute care).

When using the bed in application environments 3 and 5 (long-term and ambulant care), the values to be considered for the mattresses are 20 kg and 15 kg for accessories as well as the load that is borne by the accessories.

The maximum patient weight can therefore be taken from the following table:

| Model | Safe working load | Max. patient weight | |
|-------|-------------------|---------------------------------|---------------------------------|
| | | in application environment 1, 2 | in application environment 3, 5 |
| S 582 | 250 kg | 185 kg | 215 kg |

Distribution of the safe working load on the lying surface sections (as per DIN EN 60601-2-52:2010)

| Lying surface section | Value of the safe working load in % | Value of the safe working load in kg |
|-------------------------------|-------------------------------------|--------------------------------------|
| Back section | 45 % | 112.5 kg |
| Seat section | 25 % | 62.5 kg |
| Upper leg + lower leg section | 30 % | 75 kg |

Any use of the Völker bed other than for the purpose intended excludes the company from any possible liability.

Notes | Designated purpose 2/2

Inappropriate use

Inappropriate use can be dangerous. This includes, but is not limited to:

- Incorrect actuation of electrical functions and uncontrolled positioning,
- Operation of the care bed by the patient without having received prior instruction in how to do so,
- Use of other electrical equipment on the bed,
- Pulling on cables to move the bed,
- Removing electrical plug connections by pulling on the cable,
- Use of the bed on a slope of more than ten degrees of inclination (the bed's brakes are designed for an angle of inclination of no more than ten degrees),

- Any attempt to move the bed while it is in braked position,
- Use of the bed for transport with a vehicle,
- Overloading of the bed beyond the specified safe working load.



CAUTION If, in an emergency situation, it is impossible to avoid putting children under the age of 12 or people who are less than 146 cm tall in the bed, protective covers must be placed on the side rails. This also applies to the use of the bed by weak or confused patients.

A use for children under 8 years of age is not permitted.



WARNING The bed may not be placed right next to or stacked up with other equipment. If operation near to or stacked up with other equipment is necessary, it must be ensured that the operation of the bed is observed and correct use in this arrangement is checked.

Notes | General regulations, user training / instruction, further requirements

General regulations

The bed must only be operated and used in accordance with its designated purpose, in line with the applicable conditions, the generally acknowledged rules of technology and the occupational safety and accident prevention guidelines. The bed may **not** be operated in a faulty state that could endanger the patient, care personnel or third parties.

User training

The bed may only be operated by individuals whose training or understanding and experience offer surety for correct handling.

User instruction

The thorough induction of care personnel in the operation of the bed can be

provided by Völker or its representatives at the customer's request.

Attendance of such training can be certified and confirmed by Völker using the form provided for this purpose, specifying the name, date and signature.

Patients must be instructed in the use of the bed before care personnel hand over the hand control to them.

Other requirements

Whoever is in charge of the activation, operation or preparation of the bed must have been given a copy of these instructions for use (in printed or electronic form) and have read them.

To avoid operating errors and to safeguard the smooth operation of the bed, care personnel must always have access to the safety notes below.

Flooring requirements

Increasingly overweight patients and occupants have caused a consistent increase in demands on hospital and healthcare beds in recent years. Völker has addressed this topic by increasing the "safe working load" for the bed. However, not only are the beds exposed to higher levels of strain, but so too are the statics and the flooring. Therefore, we recommend using flooring that is designed for this strain in areas where the beds are used. This is flooring which is classified and properly laid according to DIN EN 685 minimum class 32 or 33. This is flooring for areas intended for public and industrial use with moderate or heavy traffic.

Notes | General safety notes 1/5



Warning symbols

Information marked with this symbol must always be read and strictly observed.



DANGER represents an immediate threat of danger that can cause serious physical injury or death.



WARNING represents potentially dangerous situations that can lead to serious physical injury or death.



CAUTION represents potentially dangerous situations that can cause slight physical injuries.

NOTE warns of potential damage to objects or property.

Before first activation

Before the bed is activated for the first time, care personnel must read these instructions for use in full and with care.

Before the bed is activated for the first time, care personnel must be instructed in the handling of the bed using the instructions for use. The potential dangers that can arise despite correct operation of the bed must also be indicated in full.

Before and during use

Before each use of the bed, the user must be sure that the bed is in a proper condition and that safe use is ensured (Functional check  37).



WARNING If other devices are operated on the bed, which are provided with cables, air hoses or similar, make sure that these lines are routed so that they cannot become jammed in the moving parts of the bed or be damaged.



WARNING Head and foot section are not connected to the potential equalization. Additional electrical devices should not be connected here.

Position of the bed





CAUTION To avoid injuries caused by falling, we recommend (except while care is being given) that the bed is moved into a low position.

Transporting the bed

 **CAUTION** When moving the bed, it must always be ensured that the mains connection cable does not touch the ground and that the lying surface height is at least 35 cm.

The bed should only be moved on a solid floor. Never attempt to push it over obstacles of over 2 cm in height. The maximum angle of inclination of the floor must not exceed 10°.

Securing the bed

 **CAUTION "Risk of accident"** If the bed is not being transported, the castors must always be secured, since the bed may be required as a support for when the patient stands up or lies down. If the bed rolls away while unbraked, this can lead to a serious fall. After actuating both foot pedals  40, it must be checked that the bed is actually fixed, i.e. the castors are adequately braked.

It is not technically possible to actuate the foot pedals whilst the bed is in its lowest lying surface position. The bed must therefore always be braked before it is moved into the lowest possible position.

The bed can be in an unbraked position even after first activation or reactivation and, consequently, it must be checked that the castors are correctly applied.

One-sided load on the bed

 **NOTE** In order to prevent one-sided loads on the bed, it must not be used as a seat for persons other than the patient (i.e. visitors must not sit on the edge of the bed).

Side rails

 **WARNING**
"Risk of entrapment"

In the case of patients whose physical or mental condition makes it necessary to use side rails to protect them from falling out of bed, the following safety measures must be observed:

- The legal permissibility of using side rails must be ascertained.
- The side rails may only be operated by trained care personnel.
- Ensure that the side rails (or parts thereof) are either fully raised and locked in position or completely lowered.
- It must be ensured that the patient does not come into contact with the side rail elements when the electrical lying surface adjustment mechanism is actuated. It is also important to ensure that no part of the body is sticking out through the side rails.

- If the side rails are used with a person whose psychological condition makes their use necessary, then it must be ensured that the hand control is kept out of his/her reach or its functions are locked. In addition, it is strongly recommended that side rail covers are used.

 **DANGER** If these safety measures are not observed by care personnel, injuries can be caused to hands, knees, fingers, feet, legs and hips, along with hematomas and other injuries as a result of entrapment. In children or people who are less than 146 cm tall, non-observance of these guidelines can lead to death!

 **WARNING "Danger of injury"**
If the side rails are damaged, the bed must not be used and must be repaired.

Height adjustment

 **DANGER "Risk of entrapment between the lower frame and/or floor and the bed frame when the bed is lowered"**
It must be ensured that no people, limbs, pets, bed linen or other objects are caught between the bed frame and the lower frame and/or floor.

Notes | General safety notes 4/5



DANGER

"Danger of movement"

If any movement of the bed could present a danger to the patient, all functions must be locked.

Accessories



WARNING "Risk of injury"

Only original Völker accessories should be used! Third-party accessories must undergo testing before use.

Use of lifting devices



WARNING "Risk of injury"

Only lifting devices released by Völker may be used.

The lifting devices specified are appliances that can be attached to the bed for transport purposes.

Patient lifters can be used.

Use of oxygen equipment



DANGER "Risk of fire"

Do not use any oxygen equipment other than that which is administered via nasal prongs or masks. Do not use this bed in a room where there is a risk of explosion.

Provided it has been excluded (e.g. based on information in the instructions for use of the equipment being used) that the use of the equipment may cause the O₂ concentration to rise to such a degree that there is an explosion risk, then the equipment can be used.

Rail spacers

When using the rail spacer, please read the separate instructions for use for this accessory. During technical controls, the rail spacers should also be checked to ensure they are suitable for the size of side rail used.

Cleaning and disinfection

In order to maintain consistent functioning, the bed should be cleaned, disinfected and tested as soon as possible following each use, so that it can be reused immediately without risk.

Incorrect cleaning/disinfection  52 of the bed can cause danger.

Maintenance and repair

Anyone responsible for carrying out maintenance and servicing must at least have read the safety notes for the respective bed model and be qualified in accordance with the respective national regulations. In Germany, the requirements for personnel defined by the Medical Products Operator Ordinance must be ensured by the bed operator.

Notes | General safety notes 5/5

To ensure that the beds work properly, the instructions for use and the bed service manual must always be accessible to the service personnel.

Once the maintenance work or repairs have been carried out, a corresponding control/check must be carried out on the work done. During this check, it must be determined that the bed can be used in accordance with the specifications without risk to patients, users or third parties.

The technical check must be carried out at least once a year and after every lengthy period of non-use.

Any discernible damage must be eliminated immediately.

Electromagnetic and electrostatic faults

The beds of the model S 582 satisfy the EMC requirements in accordance with the international requirements.

The basis for testing is standard EN 60601-1-2.

Functional description

The features of the Völker care bed and its function are set out in the section **Functional description**.



CONTENTS

| | |
|--|----|
| Overview | 18 |
| Hand control with hook | 19 |
| Transverse hand control (optional) | 20 |
| Nurse hand control / nurse keypad | 21 |
| Nurse hand control with total lock-out (Easy-Lock) | 22 |
| Nurse keypad with total lock-out (optional) | 23 |
| Nurse keypad with individual lock (optional) | 24 |
| Nurse keypad with individual lock / automatic functions (optional) | 25 |
| Trapeze bar and accessory holders | 26 |
| Versions and options | 27 |
| Accessories | 29 |

Functional description | Overview

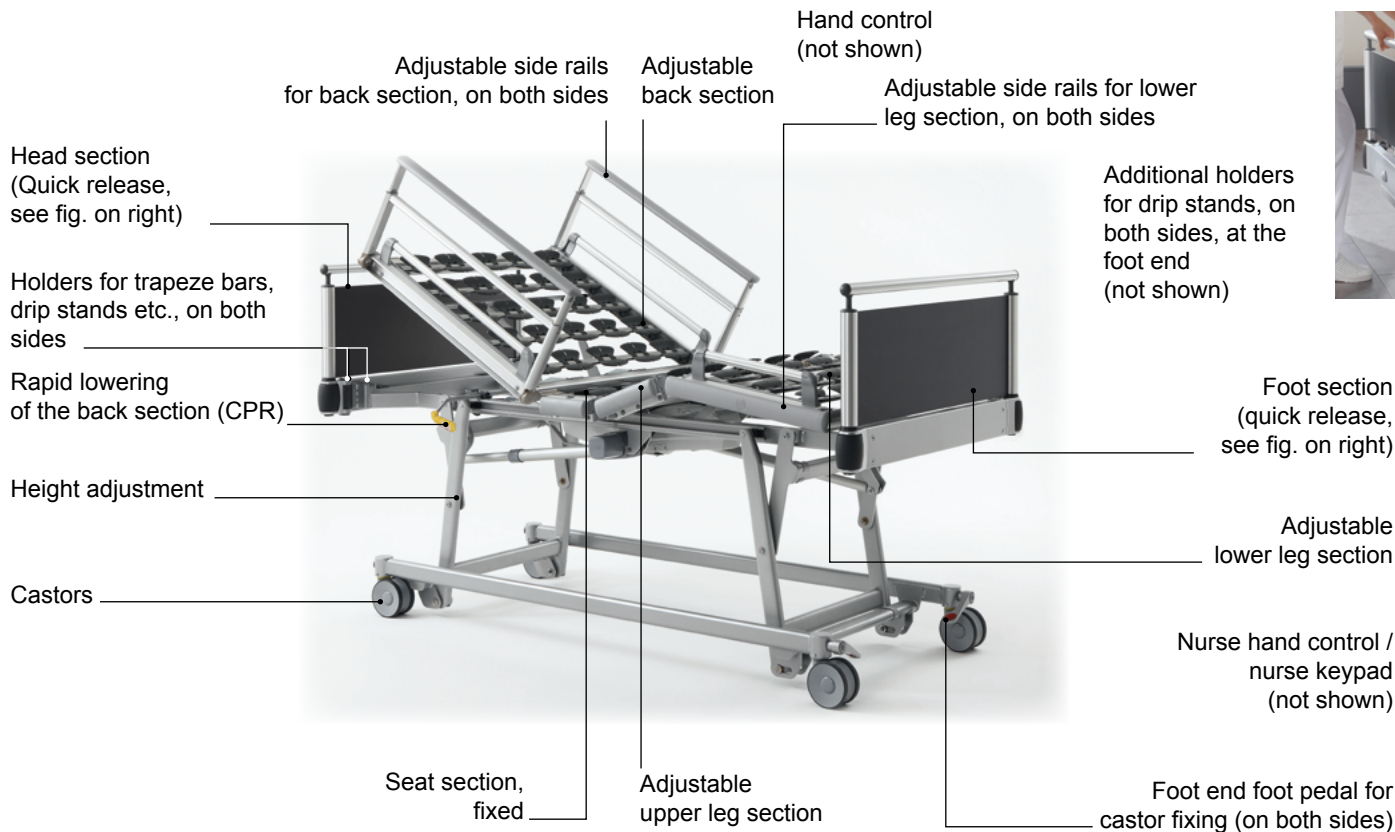

Functional description | Hand control with hook

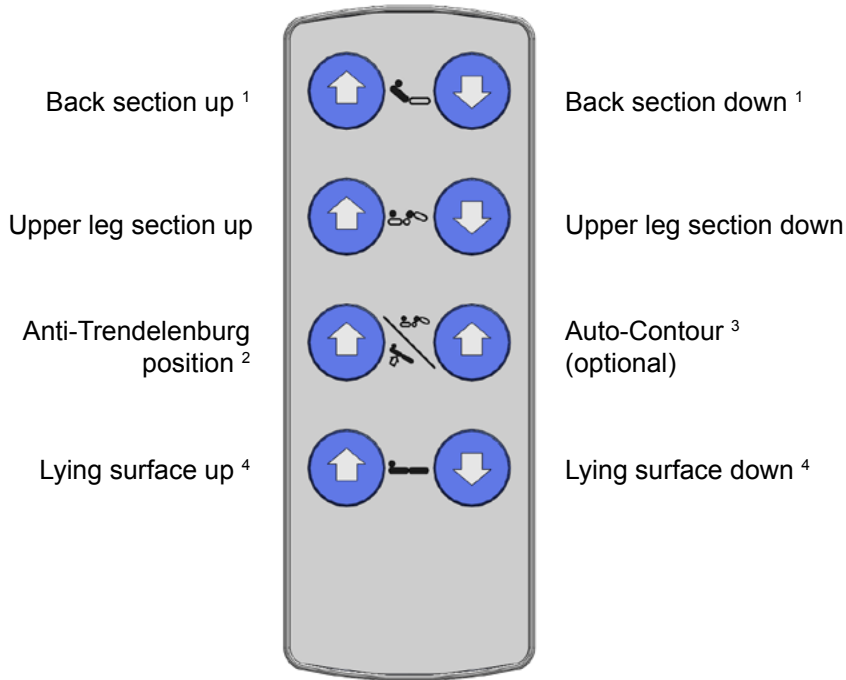

Reverse side:



Hand control locked



Hand control unlocked

¹ the Völker diagnostics system (optionally available) allows to set a time between 0 and 5 s to delay the back rest movement to the 30° position 44

² leg end lowered

³ back and upper leg section raised simultaneously

⁴ pressing the button "lying surface up" and "lying surface down" at the same time brings the bed into the horizontal position



WARNING When actuating motorized adjustments with the side rails raised, it must be ensured that the patient does not have any contact with the side rails, and that no parts of his or her body or those of other people are sticking through the side rails or are trapped between the lying surface and the lower frame and/or floor!

Functional description | Transverse hand control (optional)

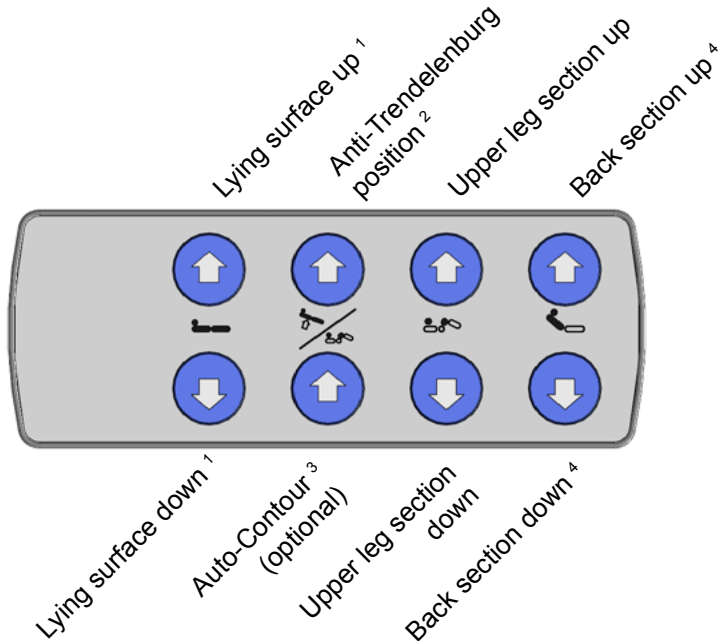

¹ pressing the buttons "lying surface up" and "lying surface down" at the same time brings the bed into the horizontal position

² leg end lowered

³ back and upper leg section raised simultaneously

⁴ the Völker diagnostics system (optionally available) allows to set a time between 0 and 5 s to delay the back rest movement to the 30° position  44

Reverse side:

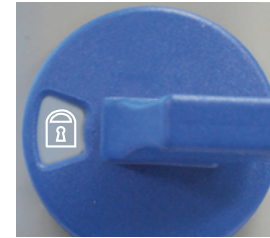

Hand control locked



Hand control unlocked



WARNING When actuating motorized adjustments with the side rails raised, it must be ensured that the patient does not have any contact with the side rails, and that no parts of his or her body or those of other people are sticking through the side rails or are trapped between the lying surface and the lower frame and/or floor!

Functional description | Nurse hand control / nurse keypad 1/5

NOTE Please note that, to operate the bed, the nurse keypads must be switched on by pressing the "on" switch. If no electric function can be activated, press the reset button on the motor housing.

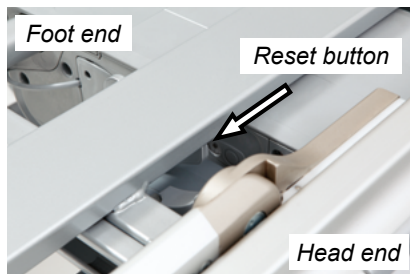

NOTE The mains voltage is connected for the duration of the active time (120 sec.) of the nurse keypad (optional) so that the LED of the mains voltage display also lights up whenever the nurse keypad is active. If the keypad switches over to its inactive state, the mains power is switched off.

⚠ WARNING When using a nurse hand control, it must be fixed in such a way that the patient cannot reach it from the normal lying position (Völker recommends the side rail of the lower leg section). If this is not possible, the nurse hand control must be locked when not in use and the key kept inaccessible to the patient.

⚠ DANGER "Risk of entrapment between the lower frame or floor and the bed frame when the bed is being lowered"
It must be ensured that no people, limbs, pets, bed linen or other objects are trapped between the bed frame and lower frame or floor during adjustment procedures.

Double-click function

The nurse keypad can be equipped with an automatic function (double-click) on a country-specific basis.

With a double-click on the "Lying surface up" or "Lying surface down" button, for example, the lying surface moves to the highest or lowest position respectively. This function can be stopped at any time by pressing any button.

The double-click function is not possible in the standard version of the bed with nurse hand control with total lock-out (Easy-Lock).

⚠ WARNING "Risk of entrapment"
If the double-click function is being used, the nurse must supervise the patient until the adjustment procedure is complete.

Functional description | Nurse hand control with total lock-out (Easy-Lock) 2/5

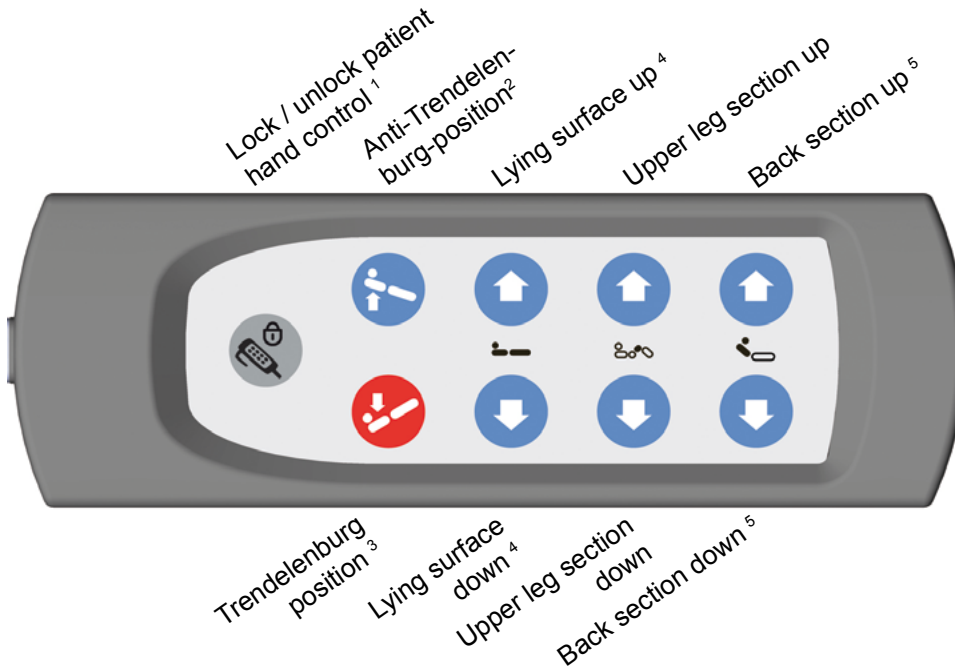

Reverse side:



Nurse hand control locked



Nurse hand control unlocked

¹ when the function is active (a red LED lights up on the nurse hand control), all functions on the patient hand control are locked

² leg end lowered

³ head end lowered

⁴ pressing the buttons "lying surface up" and "lying surface down" at the same time brings the bed into the horizontal position

⁵ the Völker diagnostics system (optionally available) allows to set a time between 0 and 5 s to delay the back rest movement to the 30° position  44



WARNING When actuating motorized adjustments with the side rails raised, it must be ensured that the patient does not have any contact with the side rails and that no parts of his or her body or those of other people are sticking through the side rails or are trapped between the lying surface and the lower frame and/or floor!

Functional description | Nurse keypad with total lock-out (optional) 3/5

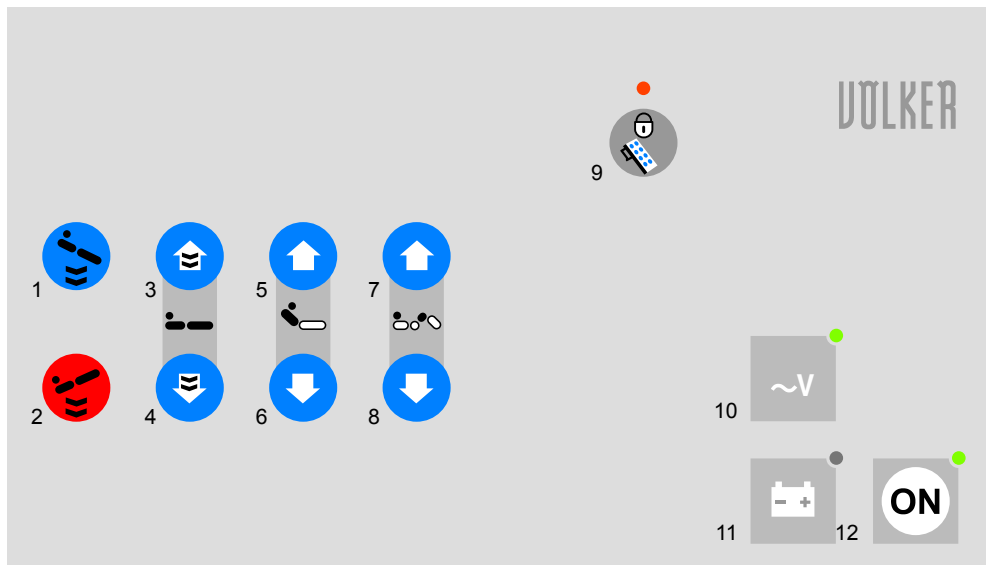

- 1 Anti-Trendelenburg position ^{A, H}
- 2 Trendelenburg position ^{B, H}
- 3 Lying surface up ^{C, H}
- 4 Lying surface down ^{C, H}
- 5 Back section up ^D
- 6 Back section down ^D

- 7 Upper leg section up
- 8 Upper leg section down
- 9 Lock hand control
- 10 Mains voltage display ^E
- 11 Battery display ^F
- 12 "ON" switch ^G

- ^A leg end lowered
- ^B head end lowered
- ^C pressing the buttons 3 and 4 at the same time brings the bed into the horizontal position
- ^D the Völker diagnostics system (optionally available) allows to set a time between 0 and 5 s to delay the back rest movement to the 30° position  44
- ^E green: mains voltage is on
- ^F green: >80% charged; yellow: 30-80% charged; red: discharged; flashing: charging
- ^G after pressing the button, the keypad is available for up to 120 sec. after the last action, then it locks automatically
- ^H automatic function with double click possible on a country-specific basis



WARNING When actuating motorized adjustments with the side rails raised, it must be ensured that the patient does not have any contact with the side rails, and that no parts of his or her body or those of other people are sticking through the side rails or are trapped between the lying surface and the lower frame and/or floor!

Functional description | Nurse keypad with individual lock (optional) 4/5

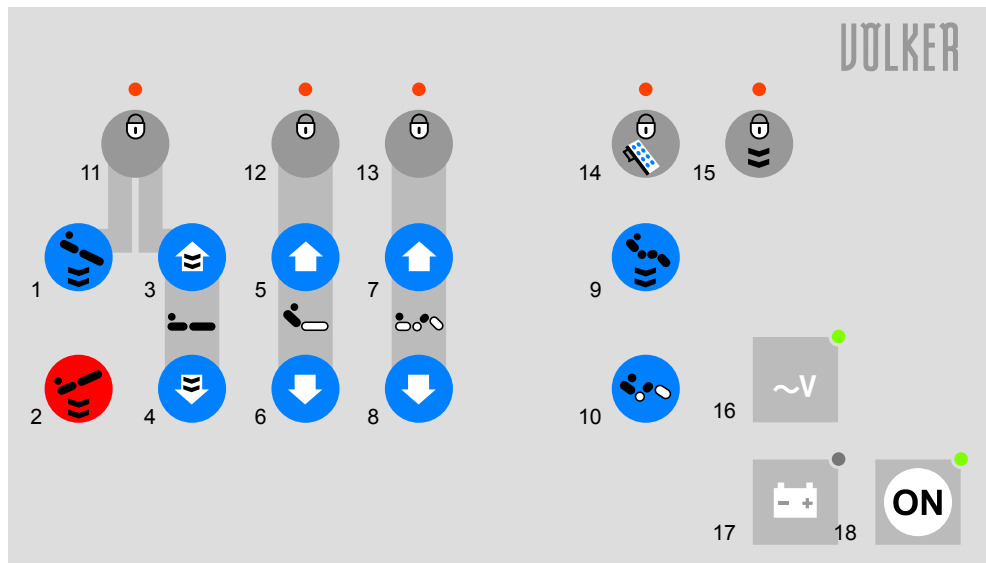

- 1 Anti-Trendelenburg position ^{A, I}
- 2 Trendelenburg position ^{B, I}
- 3 Lying surface up ^{C, I}
- 4 Lying surface down ^{C, I}
- 5 Back section up ^D
- 6 Back section down ^D
- 7 Upper leg section up
- 8 Upper leg section down
- 9 Cardiac chair position ^I
- 10 Auto-Contour ^E

- 11 Lock lying surface lifting mechanism and anti-Trendelenburg position
- 12 Lock back section
- 13 Lock upper leg section
- 14 Lock hand control
- 15 Lock automatic function
- 16 Mains voltage display ^F
- 17 Battery display ^G
- 18 "ON" switch ^H

- ^A leg end lowered
- ^B head end lowered
- ^C pressing the buttons 3 and 4 at the same time brings the bed into the horizontal position
- ^D the Völker diagnostics system (optionally available) allows to set a time between 0 and 5 s to delay the back rest movement to the 30° position 44
- ^E back and upper leg section raised simultaneously
- ^F green: mains voltage is on
- ^G green: >80% charged; yellow: 30-80% charged; red: discharged; flashing: charging
- ^H after pressing the button, the keypad is available for up to 120 sec. after the last action, then it locks automatically
- ^I automatic function with double click possible on a country-specific basis



WARNING When actuating motorized adjustments with the side rails raised, it must be ensured that the patient does not have any contact with the side rails, and that no parts of his or her body or those of other people are sticking through the side rails or are trapped between the lying surface and the lower frame and/or floor!

Functional description | Nurse keypad with individual lock/automatic functions (optional) 5/5

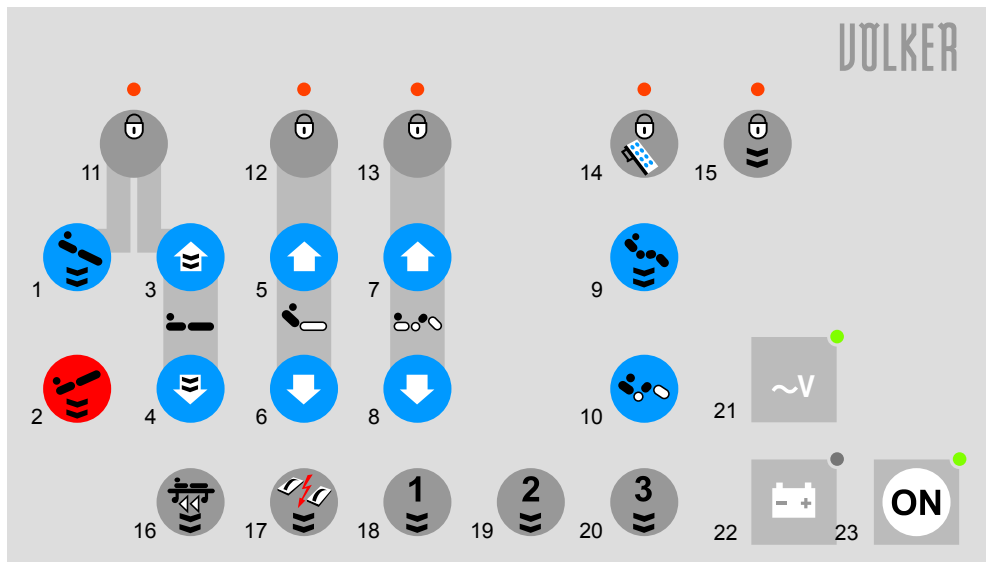

- 1 Anti-Trendelenburg position ^{A, L}
- 2 Trendelenburg position ^{B, L}
- 3 Lying surface up ^{C, L}
- 4 Lying surface down ^{C, L}
- 5 Back section up ^D
- 6 Back section down ^D
- 7 Upper leg section up
- 8 Upper leg section down
- 9 Cardiac chair position ^L
- 10 Auto-Contour ^E
- 11 Lock lying surface lifting mechanism and anti-Trendelenburg position

- 12 Lock back section
- 13 Lock upper leg section
- 14 Lock hand control
- 15 Lock automatic function
- 16 Transport position ^L
- 17 Resuscitation position ^L
- 18 Automatic washing system position ^{F, L}
- 19 Manual washing ^{G, L}
- 20 Bed preparation ^{H, L}
- 21 Mains voltage display ^I
- 22 Battery display ^J
- 23 "ON" switch ^K

- ^A leg end lowered
- ^B head end lowered
- ^C pressing the buttons 3 and 4 at the same time brings the bed into the horizontal position
- ^D the Völker diagnostics system (optionally available) allows to set a time between 0 and 5 s to delay the back rest movement to the 30° position  44
- ^E back and upper leg section raised simultaneously
- ^F height 40 cm, back and upper leg section max. engaged)
- ^G height 80 cm, back and upper leg section max. engaged)
- ^H height 80 cm, back and upper leg section in zero position)
- ^I green: mains voltage is on
- ^J green: >80% charged; yellow: 30-80% charged; red: discharged; flashing: charging
- ^K after pressing the button, the keypad is available for up to 120 sec. after the last action, then it locks automatically
- ^L automatic function with double click possible on a country-specific basis



WARNING When actuating motorized adjustments with the side rails raised, it must be ensured that the patient does not have any contact with the side rails, and that no parts of his or her body or those of other people are sticking through the side rails or are trapped between the lying surface and the lower frame and/or floor!

Functional description | Trapeze bar and accessory holders

On the inside of the head panel are two holders each for the trapeze bar and drip stands / accessories. A trapeze bar holder in the centre of the outside of the head panel is also a possible option. Two holders for drip stands are also positioned at the foot end next to the spacing castors.

The trapeze bar and other accessories must be slotted into the holders until they engage without rotating.



WARNING "Risk of falling"

The trapeze bar must not be used by the patient as a means for climbing into the bed.

The trapeze bar must never jut out beyond the outer edge of the bed and then be used as a pulling-up aid (e.g. when getting out of a wheelchair).

Optional trapeze bar holder $\varnothing 40$ mm,
outside, central (not shown)



Trapeze bar holders $\varnothing 34.2$ mm,
inside, to the side

Holders $\varnothing 25$ mm, inside, to the side
(e.g. for drip stands etc.)



WARNING "Risk of Injury"

Ensure that the trapeze bar is completely slotted into the holder and securely seated without rotating. Note: the safe working load of the trapeze bar is max. 75 kg.



WARNING Only original Völker trapeze bars should be used!



WARNING There is no potential equalization on the trapeze bar.

Functional description | Versions and Options 1/2

The standard design of the bed can be supplied with various versions and options.

Independent of the fastening option, there are optional hand controls and nurse hand controls / nurse keypads with different function keys.

| Version/ Option | Description |
|--------------------|-------------|
|--------------------|-------------|

Hand control
(versions)

With hook (standard):



Transverse on the side rail with clip
(optional):



| Version/ Option | Description |
|--------------------|-------------|
|--------------------|-------------|

Nurse
hand control
(standard)

Nurse hand control with total lock-out
(Easy-Lock) with clip on side rail:



Nurse
keypad
(optional)

Nurse keypad in bed linen storage area:



Bed exten-
sion (optional)

The bed can be extended by 28 cm with a
telescopic bed extension.

Functional description | Versions and Options 2/2

| Version/ Option | Description | Version/ Option | Description |
|-----------------------------------|--|--------------------|---|
| Trapeze bar (versions) | <ol style="list-style-type: none">1. Two trapeze bar holders Ø 34.2 mm at the head end, inside, to the side (standard).2. One trapeze bar holder Ø 40 mm at the head end, outside, central (optional). | | <p>* Measured from the top edge of the side rail to the lying surface (without the mattress).</p> |
| Bed linen storage area (optional) | An extendable bed linen storage area is possible at the foot end. | | <p>These instructions for use cover all of the versions and options listed.</p> <p>Precise details of the supplied bed designs can be found in the order specifications for your beds. If the original bed specification is no longer available, please contact Völker Customer Services.</p> <p>Make a note of the Völker serial number (ID No.) on the type label  72 before you call.</p> |
| Side rails (versions) | <p>The bed can be equipped with various side rail versions:</p> <hr/> <p>Back/lower leg section*:</p> <ol style="list-style-type: none">1. Can be pulled out up to 34* cm (standard)2. Can be pulled out up to 37 cm* (optional) (not possible with Design MA)3. Can be pulled out to 43,5 - 45 cm* (optional) (not possible with Design MA) | | |

Functional description | Accessories 1/2

To offer the greatest possible degree of flexibility, Völker offers a wide range of easy-to-attach accessories. The beds are equipped as standard with holder devices for accessories, such as drip stands and trapeze bars.

Further information about accessories can be found in our current information brochures or on the Internet at www.voelker.de. Our staff will gladly provide you with more details on the accessories that are available for your bed model.



WARNING Only original Völker accessories should be used! The fitting of the supplementary accessories (restraints etc.) is the responsibility and due care obligation of the operator.

Mattress

| Mattress size | Mattress frame size | Density |
|----------------------|---------------------|-------------------------|
| 88 x 200/210 x 12 cm | 90 x 200/210 cm | 40-50 kg/m ³ |
| 98 x 200/210 x 12 cm | 100 x 200/210 cm | 40-50 kg/m ³ |

To minimize the risk of injury, only use mattresses with the dimensions and properties detailed above. If you do not use Völker mattresses, please contact a dealer in whom you have confidence.



DANGER If mattresses are used that do not meet these specifications, there is a risk of suffocation!



DANGER The height of the raised side rails above the mattress must always be greater than or equal to 220 mm; otherwise the patient may accidentally fall out of bed. Please note that the height of the mattress has a direct influence on this.

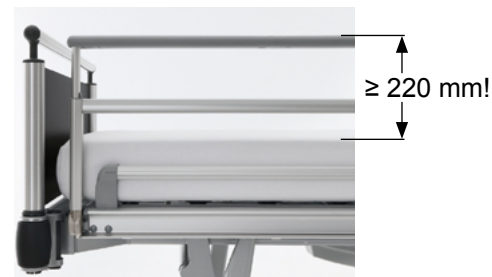

Functional description | Accessories 2/2

Use of securing systems

Securing systems such as belts should only be used exactly as specified by the manufacturer.

If securing systems in the form of abdominal belts are used, then it must be ensured that the side rails are completely raised. In this case, the gap in the middle of the rails must be closed using a rail spacer.

⚠ DANGER When using securing systems and rail spacers, please observe the separate instructions for use pertaining to these accessories.

If the patient is restrained using an abdominal belt with the help of restraint holders (Fig. 1), the lying surfaces must **never** be adjusted while the patient is restrained **and** must always be in the lowest position!

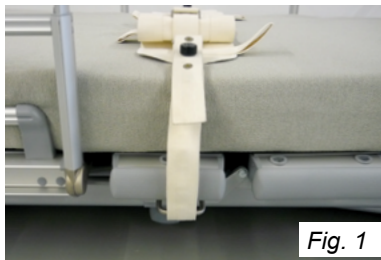



Fig. 1

The lying surface adjustment functions must be locked when a patient is secured  39, and the hand control must be kept out of the patient's reach!

To fix without using restraint holders (Fig. 2 and 3), fasten the restraints on the corresponding longitudinal section of the lying surface frame. Make sure that the restraint is passed between the mattress holder and the mattress.



Fig. 2

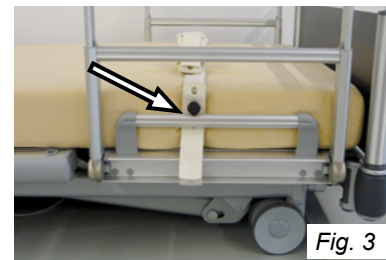

Fig. 3

Activation

The section entitled **Activation** describes the preparation of the bed for use, including the functional check.



CONTENTS

| | |
|--------------------------------|------|
| General operating instructions | 📖 32 |
| Preparation | 📖 33 |
| Electrical activation | 📖 34 |
| Using the battery pack | 📖 35 |
| Taking out of service | 📖 36 |
| Functional check | 📖 37 |

Activation | General operating instructions

On-time

The maximum on-time for the electro-motive bed functions is specified on the bed (type label  73) or on the technical data sheet.

"2 min./10 min." means that each electro-motive adjustment may be operated for a maximum of 2 minutes, after which a pause of 10 minutes is necessary (protection against overheating).

NOTE Should the maximum on-time of 2 minutes be exceeded repeatedly or for longer periods, safety cut-out devices on the bed may cause the electromechanical drive to shut down. The bed must not be maneuvered using the motors until it has cooled down sufficiently!

Battery pack

In its delivery state, the battery pack has a charge capacity that is equivalent in theory to a constant operation of minimum 10 lifting and lying surface adjustments with a working load of 250 kg.

NOTE If the bed is parked at its location and the mains plug is not connected, this will cause the battery pack to discharge due to the buffering of the electronic components!

Deep-discharged battery packs can be damaged to the extent that premature replacement is needed!

To increase the lifetime of the battery pack, it is recommended to disconnect the bed from the mains during storage (take it out of service  36).

You can find information on reactivation in the section "electrical activation"  34.

The bed should not be stored for a period longer than 6 months with a fully charged battery pack without recharging it. Appropriate and correct use of the battery pack is essential for it to have a long service life!

In order to guarantee electrical functionality at all times, the bed should be connected to the mains as often as possible.

Safety cut-out device

The bed is equipped with an electrical, self-resetting safety cut-out device that prevents the drives from overloading. In the event of very severe overloading, the bed is automatically switched off.

Activation | Preparation

Installation conditions

The bed is only approved for use in dry rooms (technical data sheet). A mains power supply and possibly a potential equalization connection are required for operation of the bed in any suitable room. When this is available and the building installation permits it, the bed should always be connected to the potential equalization.

Mechanical activation

The supplied head and foot sections must be slotted into the corner connectors on the bed frame.

Hand control connection

The hand control should be connected to the socket provided, where appropriate. The spiral cable must be routed so that it is not under tension.

NOTE To remove a hand control connector on the dual drive, you must first loosen both screws in the cover.

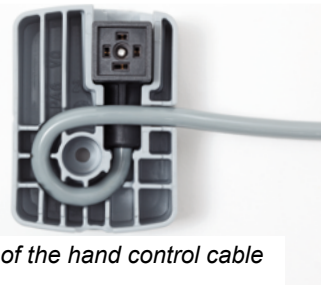
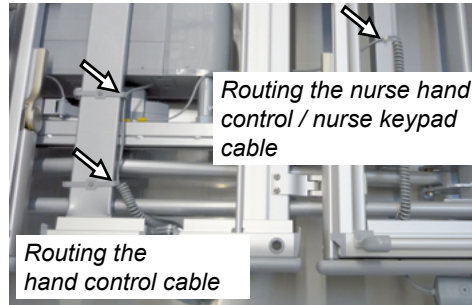

Bed transport

The bed can be moved without auxiliary transportation devices. For this, move the bed into the travel position (lying surface at a minimum height of 35 cm and release castor fixing  40).



CAUTION The bed should only be moved on a solid floor. Do not attempt to push it over obstacles of over 2 cm in height. The maximum angle of inclination of the floor must not exceed 10°. The bed can be transported by one person on even surfaces. If the bed has to be moved over falling or rising surfaces, the bed may only be transported by at least two people holding the bed at the head and foot board owing to its weight and for the safety of the patient and care personnel.



Activation | Electrical activation



WARNING Check the mains cable for damage. If the cable is damaged, the bed must not be used and must be taken out of service immediately!

NOTE Please be aware that incorrect handling of the mains cable can lead to the battery pack no longer charging. Incorrect handling includes actions such as dropping the mains isolation, pulling the cable of the mains plug to remove it from the socket, clamping the mains cable between the lying surface and lying surface frame as well as running over the cable when transporting the bed.

1. Connect mains plug to mains socket.
2. Press the green mains isolation button for one second to establish the mains connection.

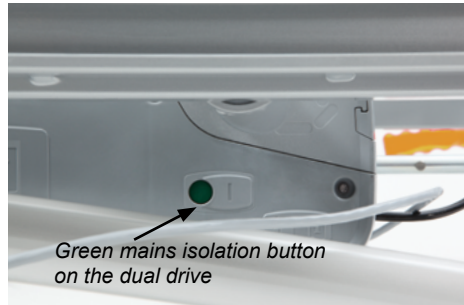

3. Unlock the locking switch (open lock visible) on the reverse of the hand control in order to activate the bed's electrical functions.



NOTE The mains isolation switch ensures that the bed is only supplied with mains voltage when an electrical function is actuated or the battery is charging.

Activation | Using the battery pack 1/2

The battery pack (optional) allows the bed to be operated independently of the mains supply in its delivery state for at least 10 adjustment cycles under full load.

The battery status can be monitored by connecting an optional nurse keypad with an LED for displaying the battery.

The LED of the battery display on the nurse keypad shows the charging status of the battery pack when the keypad is switched on:



| | |
|-----------------|--|
| Green | The battery pack is more than 80% charged. |
| Yellow | The battery pack is 30-80% charged. |
| Red | DANGER ZONE. Battery pack is discharged. |
| flashing | The battery pack is being charged. |

If the LED is red or yellow, the battery pack needs to be recharged. The battery pack is switched off shortly before deep discharging. Once the bed is con-

nected to the mains supply, press any button on the hand control to render it fully functional again. The battery pack is charged when it is connected to the mains after every use or if the charge has dropped too low.

NOTE If the bed stands for a long period without being connected to the mains supply, the battery pack can discharge. The degree of discharge depends on the environmental conditions.

To increase the lifetime of the battery pack, it is recommended to disconnect the bed from the mains during storage. For this purpose, press the buttons “back section down”, “upper leg section down” and “lying surface down” at the same time on the hand control or the nurse hand control, or the buttons “back section down”, “upper leg section down” and “ON” on the nurse keypad.

The bed should not be stored for a period longer than 6 months with a fully charged battery pack without recharging it.





WARNING If electromagnetic interference occurs with other equipment in the area around the bed, please refrain from using these devices.

When the bed is being transported, it must always be handled carefully and protected from moisture.

Activation | Using the battery pack 2/2 and taking out of service

NOTE The bed is designed for use in an ambient temperature range from 10 °C to 40 °C with a relative air humidity of 30% to 75%, an air pressure of 700 to 1060 hPa and a maximum operating height of 3000 m.

 **WARNING** The battery pack must only be replaced by personnel trained by Völker GmbH.

 **WARNING** If the battery pack is faulty, degassing can occur. In rare cases, this can cause deformation of the battery pack housing. If this occurs, the bed must be immediately taken out of service and taken to an adequately ventilated room without sparks (from electricity or fire). Immediately inform customer services should this occur!

 **WARNING** The battery pack must be disposed of in an environmentally friendly manner at the appropriate facilities. Alternatively, you can return it to Völker GmbH.

To activate the hand control and the nurse hand control / nurse keypad once the bed has been switched on, the function key lock  39 must possibly be disabled.

Taking out of service

Should the bed be taken out of service for longer than two weeks, pull out the mains plug and press the buttons “back section down”, “upper leg section down” and “lying surface down” at the same time on the hand control or the nurse hand control, or the buttons “back section down”, “upper leg section down” and “ON” on the nurse keypad in order to disconnect the bed from the power supply.

The mains plug must also be pulled out and the buttons „back section down“, „upper leg section down“ and „lying surface down“ on the hand control or nurse hand control, or the buttons „back section down“, “upper leg section down” and “ON”, pressed on the nurse keypad before carrying out repair work.

Activation | Functional check

Visual inspection

Before each new occupancy of the bed, the following checks must be carried out:

1. Ensure the bed exhibits no visible signs of damage.
2. Ensure that the insulation of the electrical cable is intact.
3. Ensure that the next testing date has not been missed (see testing label).



WARNING Only undamaged beds that are still within their testing interval periods may be used!

Function test

A functional check must be carried out before each new occupancy:

1. All electrical functions must be actuated to their terminal positions once.
2. The function of all side rails must be checked.
3. The secure position of the bed must be checked.

Once a fault-free functional check has been carried out, the bed is ready for use.

Operation

The **Operation** section provides you with all the information required to operate the Völker bed.



CONTENTS

| | |
|---|----|
| Key lock | 39 |
| Castor fixing | 40 |
| Side rails | 41 |
| General safety notes | 41 |
| Side rails | 42 |
| Back section | 44 |
| Mechanical rapid lowering of the back section / CPR function (optional) | 45 |
| Upper and lower leg sections | 46 |
| Lying surface height | 47 |
| Anti-Trendelenburg- and Trendelenburg position | 48 |
| Comfort seating position | 49 |
| Bed extension (optional) | 50 |

Operation | Key lock

Activating the hand control key lock or the nurse hand control / nurse keypad key lock disables its / their functions completely.

The hand control can be locked either on the hand control itself or on the nurse hand control / nurse keypad.

A locking switch is located on the reverse of the hand control and the nurse keypad with total lock-out (Easy-Lock). It is unlocked (open lock visible) and locked with the key. The patient hand control can also be locked with the

button "lock hand control"  on the

nurse hand control and/or  nurse

keypad. This lock only affects the patient hand control and can be identified by the red LED on the nurse hand control.

The nurse keypad must be switched on by pressing the on switch to operate the bed. It locks automatically 120 sec. after the last actuation.

If the bed functions cannot be actuated, check whether the key lock is activated.

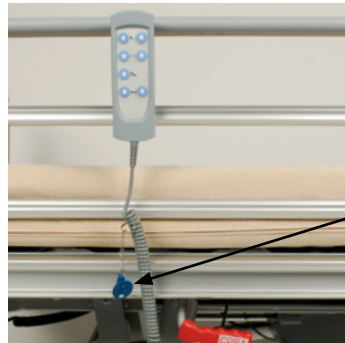

Key

The key should be removed from the bed when it is not required.

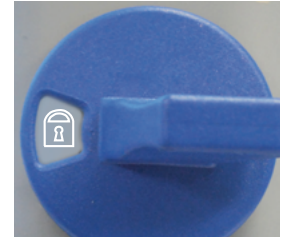

Hand control and/or nurse hand control locked



Hand control and/or nurse hand control unlocked

Operation | Castor fixing

To brake the bed, step on the red spots of both foot pedals. As soon as **both** foot pedals are engaged in a 30° position, the bed is braked.



To move the bed into the desired position, move both foot pedals into a horizontal position.

To move the steering castor into the direction of travel, push the left foot pedal (seen from the patient's view) right up. As soon as the foot pedal is engaged in a 30° position, the castor is fixed and the bed can be steered safely.

To move the bed, the castor fixing must be released by operating the foot pedals. When moving the bed, the lying surface must be at a height of at least 35 cm.



CAUTION "Risk of accident"

If the bed is not being transported, the castors must always be locked, since the bed may be required as a support when the patient stands up or lies down. If the bed rolls away while unbraked, this can lead to a serious fall. After activating both foot pedals  35, it must be checked that the bed is actually fixed, i.e. the castors are adequately braked.

The bed can be in a non-fully-braked condition even after first activation or reactivation and, consequently, it must be checked that the castors are braked correctly.



Both foot pedals down: bed braked.



Both foot pedals horizontal: all castors free.

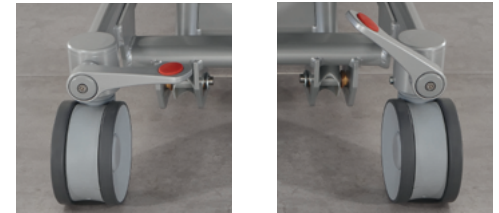

Right foot pedal horizontal and left foot pedal up (seen from the patient's view): moving position (steering castor engaged).

Operation | Side rails | General safety notes



WARNING All people whose duties involve maneuvering of the side rails must have read and understood the following information:

- When actuating the back, upper leg or lower leg section adjustment, the lift or the side rails, it must always be ensured that the patient is not touching the side rails, and that no part of his/her body is sticking out through the side rails.
- If the side rails are used for an individual whose psychological condition necessitates their use, it must be ensured that the hand control is kept completely out of his/her reach or its functions are completely locked out. In all cases, care must be taken to ensure that risks are minimized.
- Protective covers (cot side pads) are available as an accessory for the side rails. These provide additional protection against injury from contact with the side rails. The use of these protective covers is recommended for all persons for whom the risk of injury from unavoidable contact with the side rails is very high. Even with the covers, the care staff or patient must still take the necessary care when operating the bed.
- If the side rails are used, they must always be either completely raised and securely engaged, or completely lowered to the end stop. Because of the risk of entrapment, they must **never** be left in a position where they are not completely engaged.
- If the side rails are damaged, there is a risk that the patient will fall out of bed.

Operation | Side rails 1/2

Raising the side rails

1. Pull the side rail element out horizontally until the end stop, and raise it upwards.
2. To adjust the height of the side rail, pull the telescopic section upwards until it reaches its end stop.

Lowering the side rails

1. Press both buttons on the outside of the frame, right under the cross-member, to bring the height-adjustable side rail element to its lowest position.



2. Press the "Drücken / Press" trigger at the lower edge of the side rail element and tilt it sideways into a horizontal position, so that it lies parallel to the floor.

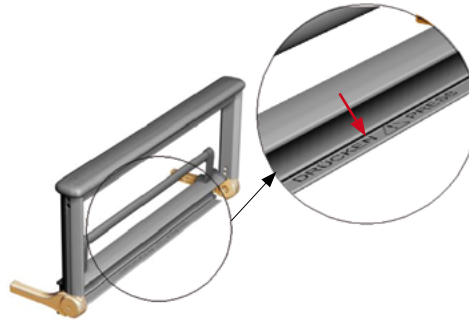

3. Push the rail element completely underneath the lying surface.

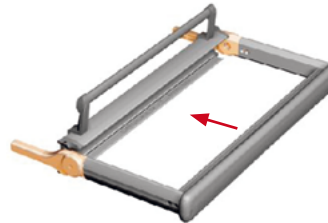

The side rail elements can be used individually or together as required to protect the patient.

Raising all four rail elements offers the patient maximum protection.

⚠ WARNING The side rails should always be gripped with two hands at the ends of the element in question and guided upwards or downwards.

⚠ CAUTION Any weight on side rail elements that are pulled out horizontally must not exceed 15 kg!

Operation | Side rails 2/2

NOTE Due to their exceptional stability, the side rail elements can also be used as a surface for storing bed clothes (max. 15 kg) or as an additional supporting surface for care-related positions, such as Bobath treatments, or for the performance of physiotherapy-related treatments.

Operation | Back section

The back lying surface can be adjusted using the hand control or the nurse hand control / nurse keypad.

If necessary, disable the hand control lock and/or nurse hand control / nurse keypad lock
📖 39.

The back section of the lying surface can be raised up to an angle of max. 70°.

⚠️ WARNING When the back section is being raised with the side rails up, it must be ensured that none of the patient's or any other person's body parts are sticking out through the side rails or are on top of them!

⚠️ WARNING "Risk of entrapment" When adjusting the position of the back section, do not touch the frame in the area of the back section!

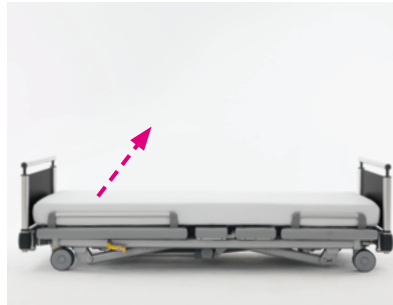

Back section up/down



Hand control



Back section up/down

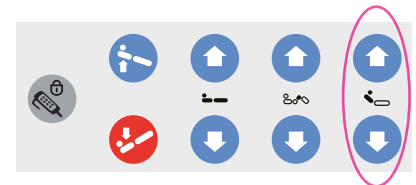

Nurse hand control

NOTE The Völker diagnostics system (optionally available) allows to set a time between 0 and 5 s to delay the back rest movement to the 30° position. If this function is set up, the back section automatically stops at the 30° position when being adjusted. Take your finger off the button if you would like to stay in this position or continue pressing the button so that the back section keeps moving after the delay time.

Operation | Mechanical rapid lowering of the back section / CPR function

The bed is fitted with a mechanical rapid lowering function of the back section for resuscitation.

⚠ WARNING The CPR function (Cardiopulmonary Resuscitation function) may only be operated by qualified personnel!

Hold the back section on the mattress holder and pull the red lever located at the left or right underneath the back section of the lying surface upwards to lower the back section quickly. The back section can now be moved quickly downwards.

The lowering process can be interrupted by letting go of the red lever.

⚠ WARNING The back section must always be held on the mattress holder so that the bed is not lowered suddenly with the patient!

Red lever for mechanical rapid lowering of the back section for resuscitation:



Operation | Upper and lower leg sections

The position of the upper leg lying surface can be adjusted using the hand control or the nurse hand control / nurse keypad.

If necessary, disable the hand control lock or nurse hand control / nurse keypad lock  39.

The upper leg section of the lying surface can be raised up to an angle of max. 45°.

The lower leg section can be moved manually to any position of maximum 16° by pulling on the mattress holder.

To lower the lower leg section, the mattress holder is pulled and the section lifted to the end stop and then lowered. The locking mechanism is disengaged automatically.

 **WARNING** When the upper or lower leg section is being raised with the side rails up, it must be ensured that none of the patient's or any other person's body parts are sticking out through the side rails or are on top of them!



Upper leg section up/down



Upper leg section up/down

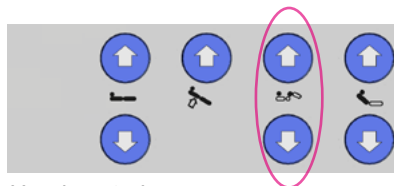

Hand control

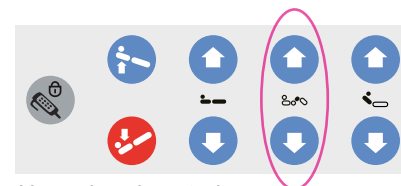

Nurse hand control

 **WARNING "Risk of entrapment"** When the position of the upper leg section is being adjusted, there is a risk of entrapment between the raised side rail and the foot section.

Operation | Lying surface height

The position of the entire lying surface can be adjusted using the hand control or the nurse hand control / nurse keypad.

If necessary, disable the hand control lock or the nurse hand control / nurse keypad  39.

The lying surface height can be adjusted from 25 cm to 80 cm (for optional Integral S castors Ø150 mm: 30.5-85.5 cm).

 **WARNING** To avoid danger to the patient from falling, we recommend that the bed be lowered all the way except when delivering care.

 **DANGER** Before lowering the bed, it must be ensured that no people, limbs, pets, bed linen or other objects are trapped between the lying surface and the lower frame or floor. The bed's position must be stable (castors braked) when the patient is getting in and out of the bed!

 **CAUTION** Since it is technically impossible to actuate the foot pedals at the lowest lying surface position, the bed must always be braked before it is moved into the lowest possible position.

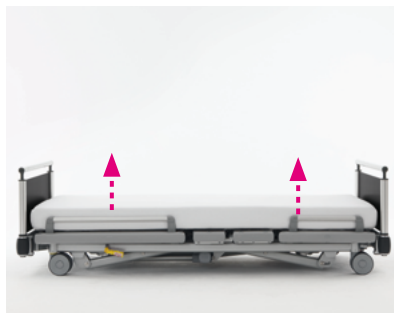

Lying surface up/down



Lying surface up/down



Hand control



Nurse hand control

 **WARNING** When the height adjustment mechanism is actuated with the side rails up, it must be ensured that the patient does not have any contact with the side rails and that no parts of either the patient's body or those of other persons are sticking out through the side rails!

Operation | Anti-Trendelenburg ¹ and Trendelenburg position²

The Trendelenburg position can only be set using the nurse hand control / nurse keypad.

If necessary, disable the nurse hand control / nurse keypad lock  39.

The Trendelenburg position can be adjusted up to an angle of 12°.

 **CAUTION** If a fault occurs with the lifting function, or the mains power supply fails and the battery pack is completely discharged, the Trendelenburg function can no longer be engaged. The patient may have to be transferred to a different bed!

 **WARNING** Since the Trendelenburg position depends on clinical indications, it must only be used with appropriate approval.

The lying surface is automatically returned to its horizontal position if it is moved to its highest or lowest position.

Alternatively, the lying surface can be moved into the horizontal position by pressing both buttons for the lying surface adjustment



at the same time.



Anti-Trendelenburg position ¹



Anti-Trendelenburg position ¹
Trendelenburg position ²

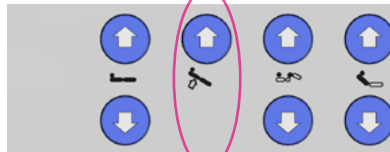

Hand control



Nurse hand control

¹ Leg end lowered

² Head end lowered

Operation | Comfort seating position



Patients who are unable to leave the bed either because their circulatory situation is too unstable or because they first have to be "taught" how to sit can gain a lot of benefit from the comfort seating position. This ensures an active seating posture in the bed.



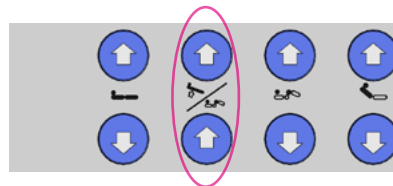





Anti-Trendelenburg position







Auto-Contour

Hand control with anti-Trendelenburg position and Auto-Contour (optional)

Adjusting the comfort seating position

1. Move the back  
and upper leg sections  
upwards slightly into a comfortable position.
You can alternatively reach this position in one step by pressing the Auto-Contour button   (optional).
2. Swivel the bed to the comfort seating position by pressing the Anti-Trendelenburg   button .

Restoring the straight lying surface

To return to a horizontal lying position, move the lying surface  and the back   and upper leg section   in any preferred order to their lowest position.

Operation | Bed extension (optional)

The bed can be extended by 28 cm using a telescopic bed extension (optional).

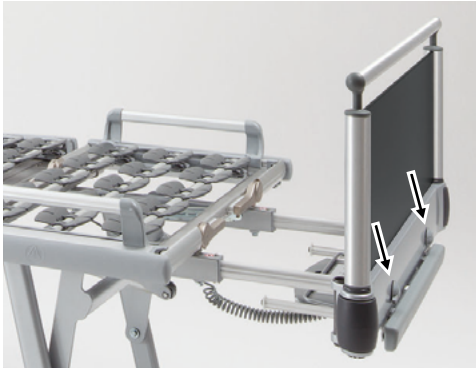



To pull out the bed extension, push the two lever buttons downwards simultaneously.

Cleaning and disinfection

This section contains details on the **cleaning and disinfection** of the bed.



CONTENTS

| | |
|--|--|
| Cleaning |  52 |
| Wash and spray disinfection |  52 |
| Spray lances and automatic washing systems |  53 |

Cleaning and disinfection 1/2

In order to maintain consistent functioning, the bed should be cleaned, disinfected and tested as soon as possible following each use, so that it can be reused immediately without risk. Incorrect cleaning/disinfection of the bed can cause danger.

Cleaning

Depending on the degree of soiling, we recommend cleaning the bed with a damp cloth or similar.

Wipe and spray disinfection

For wipe and spray disinfection, the disinfecting agents featured in the VAH (Verbund für angewandte Hygiene e.V.) list can be used in their specified concentrations. They must be applied at the dilution ratio specified by the relevant manufacturer's instructions for use.

NOTE Solvents are not permitted.

Grinding agents, scouring pads or other dulling substances must not be used.

Organic solvents such as halogenated / aromatic hydrocarbons and ketones must not be used.

The following instructions must be observed when using cleaning and disinfecting agents:

- The working solutions should generally be freshly prepared.
- The concentrations used should be neither higher nor lower than those given in the list. The so-called "shot" method should not be used under any circumstances. Under no circumstances should someone using a disinfectant follow their own judgement to add a cleaning agent such as soap or washing-active substances (leads to soap failure).

- There is a risk of fire or explosion from alcoholic spray disinfectants when these are used over large areas.
- They must not contain any corrosive or irritant components.
- They must not contain any substances that change the surface structure or gripping properties of the materials.
- Lubricants must not be affected.
- The pH value of the water must be no higher or lower than 6-8.
- Water should not exceed a total water hardness of 0.9 mmol/l (corresponding to 5 °dH).

Cleaning and disinfection 2/2

The specifications in the VAH list, as well as the specifications we have issued, do not absolve the user of the obligation to carry out his or her own checks and tests, since the ratios (e.g. water hardness) can vary depending on the geographical location. It is therefore impossible to offer legally binding assurance of certain properties.

If unsuitable washing and disinfecting agents are used, if the mixing ratio is incorrect or if the beds are not adequately cared for, damage can occur to the surface coating for which Völker GmbH is not liable.



WARNING "Risk of electric shock / fire and functional failure"

The bed must always be disconnected from the power supply during cleaning and disinfection.

The plug and the socket of the hand control are only protected against spray when the control is stowed and the appropriate cover is in place.

Spray lances and automatic washing systems

Cleaning and disinfection using spray lances from high-pressure cleaning equipment and in automatic bed washing systems is **not** permissible.

Maintenance

The **Maintenance** section contains information on how to carry out maintenance work.

CONTENTS

| | |
|----------------------|----|
| Staff training | 55 |
| Safety notes | 55 |
| Maintenance schedule | 56 |



Staff Training

Anyone responsible for carrying out maintenance and servicing must at least have read the safety notes for the respective bed model and be qualified in accordance with the respective national regulations. In Germany, the requirements for personnel defined by the Medical Products Operator Ordinance must be ensured by the bed operator.

To ensure that the beds work properly, the instructions for use and the bed service manual must always be accessible to the service personnel.

Safety notes

During maintenance and technical checks, the following specifications must be strictly observed:

- The room's electrical installations must satisfy the current technical requirements and the bed must be used correctly.
- The castors must be placed in the "brake position".
- The beds are not protected against explosion and must therefore only be maintained in an environment free from flammable substances and materials.

 **WARNING** Before carrying out repair work, always disconnect the mains plug **and** disconnect the bed from the battery pack by pressing the buttons "back section down", "upper leg section down" and "lying surface down" on the hand control or the nurse hand control, or the buttons "back section down", "upper leg section down" and "ON" on the nurse keypad at the same time!



WARNING Maintenance and repair work should only be carried out after the bed has been disinfected.



WARNING Maintenance and repair work should only be carried out on an unoccupied bed. The patient may also have to be transferred to another bed before starting the work.



WARNING After maintenance (repair) work is complete, always check that the bed is functioning correctly. It must be checked that the bed can be used correctly without risk to the patient or care personnel.

Maintenance | Maintenance schedule

The bed requires little maintenance. All movable parts for the height adjustment mechanism, the lying surface drives and the side rails are provided with long-lasting lubricant at the factory. It is recommended that **the bed is subjected to a regular, or at least once a year, technical control** 📖 57 (incl. **visual inspection and functional check**) as described in the checklist 📖 84. Any discernible damage must be eliminated immediately.

After every lengthy period of non-use, a visual inspection and functional check 📖 37 must be carried out.











| Period | Works to be performed |
|----------------------------------|--|
| Annually | Technical control 📖 57 Lubrication of the castors in the C profiles under the lying surface with vaseline |
| After lengthy periods of non-use | Visual inspection and functional check 📖 37 |
| If required, | Lubrication of mechanical parts Replacement of the battery pack if defective Replacement of wearing parts if defective <ul style="list-style-type: none">• Wings (if fitted)• Spring elements (if fitted) |

Technical control

The section entitled **Technical control** contains all the information needed to carry out the technical control in accordance with MPBetreibV, BGVA3, UVV on hospital and healthcare beds and measurement as per DIN EN 62353 (Form  84). Other (e.g. country-specific) specifications have not been included here. This does not absolve the operator from the obligation to observe any such specifications.

| Project, address, customer no.: | | | | | | |
|---|--|----------|---------------------|--------------|----------------|--|
| Type of bed, product, location of the bed: | | | | | | |
| Bed identification (e.g. facilities own identification or Völker ID-no.): | | | | | | |
| Date of check: | | | Name of technician: | | | |
| Kind of check | Component to be checked | Actually | Accepted | Not accepted | Not applicable | |
| Visual inspection | Inscription on device readable | | | | | |
| | Instructions for use available | | | | | |
| | Base frame | B* | | | | |
| | Lying surface, wing and spring elements (if existing) | B* | | | | |
| | Trapeze bar adapter, infusion bar adapter | B* | | | | |
| | Power supply cable, plug or charger, charging connection | B* | | | | |
| | Strain relieve, bend protection, cable hook | B*/S* | | | | |
| | Connecting cable, plug-in contacts, blind plugs | B*/S* | | | | |
| | Positioning (spacing 1 mm) and sensor cabling (only Vis-a-Vis-bed) | B*/S* | | | | |
| | Housing (motor, control electronics) | B* | | | | |
| | Hand control (housing, cable) | B* | | | | |
| Nurse keypad / nurse hand control (housing, cable) | B* | | | | | |

CONTENTS

| | |
|---|----|
| Visual inspection  | 58 |
| Functional check of the side rails  | 58 |
| Functional check of the brakes  | 59 |
| Functional check of the drives  | 59 |
| Mains connection cable  | 59 |
| Cabling  | 59 |
| Housing  | 59 |
| Mechanical check  | 59 |
| Measurement in accordance with DIN EN 62353  | 60 |
| Checking the trapeze bar grab handle  | 60 |
| Further accessories  | 60 |

Technical control 1/3

1. Visual inspection

Check the frame parts for plastic deformations and/or wear. Amongst other things, these include: the lower frame, the lifting mechanism, all parts of the lying surface (back, seat, upper leg and lower leg sections, wings and spring elements (if fitted)), trapeze bar, trapeze bar holder and steering castors.

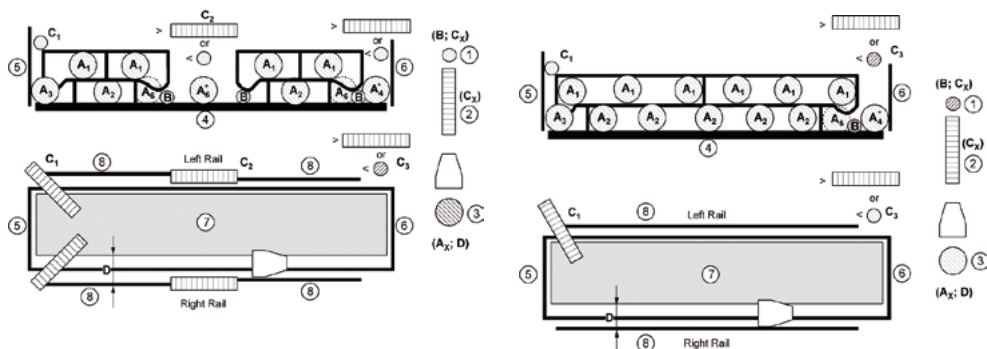

2. Functional check of the side rails

The side rails must be checked in accordance with DIN EN 60601-2-52.

Check that the locking mechanism for the side rails is working correctly and that there are no visible deformations or signs of wear on the side rails.

Check that the prescribed distances are maintained, even when the side rails are placed under load. All measurements of the side rail distances should be made in the flat lying surface position, since the dimensions given while the bed is otherwise positioned do not show less favorable conditions.

| Letter | Description | Dimension |
|------------------|---|---|
| A _x | The distance between elements within the scope of the SIDE RAIL in its raised/engaged position or of the area formed by the SIDE RAILS and the fixed parts of the BED or ACCESSORIES. | < 120 mm |
| B | not applicable | - |
| C ₁ | Distance between HEAD SECTION and SIDE RAIL | < 60 mm |
| C _{2,3} | Distance between divided SIDE RAIL and distance between SIDE RAIL and FOOT SECTION | < 60 mm or > 318 mm |
| D | Area between SIDE RAIL and MATTRESS | 120 mm cone may sink max. 60 mm under the mattress surface without pressure |
| G | Height of the upper edges of the SIDE RAILS above the mattress without compression over at least 1/2 of the length of the LYING SURFACE | ≥ 220 mm |

Technical control 2/3

The measurement of A and D must be performed using a cone as defined in DIN EN 60601-2-52. The force used for measurement A must be at least 250 N.

3. Functional check of the brakes

Check that the brake is functioning correctly (safety, braked, free running).

4. Functional check of the drives

Travel through the full adjustment range of each motor. Look out for any unusual noises, watching the speed, ease of running etc., and check that the selected function travels in the correct direction. In particular, ensure that the motor switches off automatically when it reaches its terminal position*.

* Please note that the terminal position can vary from bed model to bed model. Please consult the technical specifications for this or, if in doubt, contact our service department.

5. Mains connection cable

Check

- the mains connection cable, including cable guides,
- the strain relief, including kink protection sleeve,
- the mains connection plug
- the cable hooks

for damage.

6. Cabling

Check the cable guide and that the plug contacts are correctly seated and do not exhibit any damage.

Check the cables for damage.

7. Housing

Check all housings for damage. All screws must be firmly tightened and seals must not exhibit any visible damage.

8. Mechanical check

Check the function of the Rastomat by manually moving the lower leg section to the individual positions.

Technical control 3/3

9. Measurement as per DIN EN 62353

The bed must be checked electrically in accordance with DIN EN 62353. The leakage current should be measured by means of alternative measurement. The max. measured value must be less than or equal to 500 μ A. Please note that the green mains isolation button  34 must be pressed throughout the whole measurement.

On beds with a potential equalization connection (see diagram below), the impedance of the potential equalization within the bed must also be measured. The impedance must be less than 0.2 Ω ($I=5\dots25$ A, $R=U/I < 0.2 \Omega$).

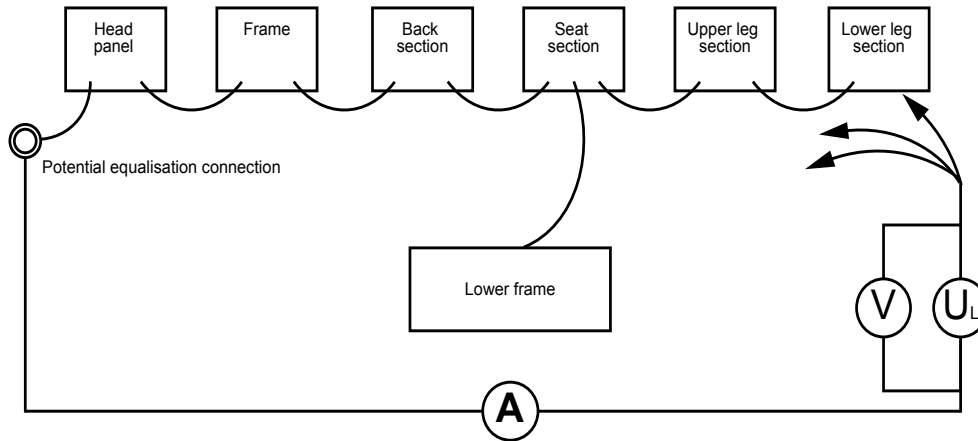

10. Trapeze bar grab handle

Check whether the plastic and holding frame of the trapeze bar grab handle exhibit any damage and that the fixing rods on the trapeze bar are intact.

The handle of the trapeze bar and fastening strap must be replaced in the following cycles:

- every 5 years: Trapeze bar grab handle and trapeze bar grab handle with roll function in elderly care service
- every 3 years: Trapeze bar grab handle with roll function in hospital service.

11. Further accessories

Further accessories must always be checked in accordance with the manufacturer's instructions.

Troubleshooting

The section entitled **Troubleshooting** contains a table of faults for users, together with information on the service points.

CONTENTS

| | |
|-----------------|----|
| Table of faults | 62 |
| Service points | 66 |



Troubleshooting | Table of faults 1/4

The table below contains information on possible problems that users can resolve themselves.

Anyone responsible for carrying out maintenance and servicing must at least have read the safety notes for the respective bed model and be qualified in accordance with the national regulations. In Germany, the requirements for personnel defined by the Medical Products Operator Ordinance must be ensured by the bed operator.

To ensure that the beds work properly, the instructions for use and the bed service manual must always be accessible to the service personnel.





NOTE Before carrying out any troubleshooting, check that the bed is connected to the power supply (the mains plug is in a live socket). Then turn the nurse keypad on and ensure that the battery pack is charged (observe the LED of the battery display on the nurse keypad).

If the same fault occurs repeatedly, read out the error memory from the optional Völker Diagnostic System (VDS) before resetting it.







WARNING Before carrying out repair work, always disconnect the mains plug **and** disconnect the bed from the battery pack by pressing the buttons “back section down”, “upper leg section down” and “lying surface down” on the hand control or the nurse hand control, or the buttons “back section down”, “upper leg section down” and “ON” on the nurse keypad at the same time!

Troubleshooting | Table of faults 2/4

| Fault | Possible cause | Troubleshooting |
|---|---|---|
| Adjustment of the back or upper leg section is not working. | (1) Hand control locked. (2) Nurse hand control / keypad locked. (3) The mains plug is not plugged in or there is no power to the socket and battery pack is discharged. (4) Bed taken out of service. (5) Failure or communication error in the electronics. (6) Hand control faulty. (7) The nurse hand control / keypad is faulty. | (1) Unlock hand control  39. (2) Unlock nurse hand control / keypad  39. (3) Connect the plug or check the socket. Then press the green mains isolation button  34 (4) Press the green mains isolation button  34. (5) Press the reset button  21 on the dual drive, and then press any hand control function. (6) Replace hand control. (7) Replace nurse hand control / keypad |
| Adjustment of the back section is not working. | (1) CPR lever jammed. | (1) Check whether the CPR lever is jammed and correct if necessary. |

 *Continued on next page*

Troubleshooting | Table of faults 3/4

| Fault | Possible cause | Troubleshooting |
|---|--|---|
| Adjustment of the lower leg section is not working. | (1) Lower leg section must be adjusted manually. | (1) Adjust lower leg section manually. |
| The bed cannot be adjusted in height. | (1) Hand control locked. (2) Nurse hand control / keypad locked. (3) The mains plug is not plugged in or there is no power to the socket and battery pack is discharged. (4) Bed taken out of service. (5) Failure or communication error in the electronics. (6) Hand control faulty. (7) Nurse hand control / keypad faulty. | (1) Unlock hand control  39. (2) Unlock nurse hand control / keypad  39. (3) Connect the plug or check the socket. Then press the green mains isolation button  34. (4) Press the green mains isolation button  34. (5) Press the reset button  21 on the dual drive, and then press any hand control function. (6) Replace hand control. (7) Replace nurse hand control / keypad. |

 Continued on next page

Troubleshooting | Table of faults 4/4

| Fault | Possible cause | Troubleshooting |
|---|---|--|
| <p>The bed is adjusted upwards in pendulum mode (unsynchronized height adjustment).</p> <p>NOTE The bed has a pendulum mode as a protective function which serves to improve the quality in terms of availability. Please only contact our service department if the pendulum swings constantly.</p> | <ol style="list-style-type: none">(1) Height of lying surface has not been adjusted for a long time.(2) Bed has been overloaded. | <ol style="list-style-type: none">(1) Adjust height of lying surface several times.(2) Ensure safe working load. Where necessary, put less weight on the bed. |

Troubleshooting | Service points

If necessary, please seek assistance from the relevant contact at your nearest Völker sales organization. You will receive all the information you need for comprehensive service promptly.

Appendix

The **Appendix** section contains the technical specifications and classifications, details on the service life and disposal of the equipment and links to the manufacturers' declarations and forms found in the appendix.

Konformitätserklärung

Anhang VII
EU-Richtlinie 93/42/EWG

Der Unterzeichnende
Völker GmbH
Wullener Feld 79
58454 Witten

mit einer Fertigungsstätte unter der Adresse:
Völker GmbH
Ahornstraße 4
09661 Hainichen

bestätigt, dass die nachfolgend bezeichneten
Produkte in der von uns in Verkehr
gebrachten Ausführung die grundlegenden
Anforderungen des Anhangs I der EU-
Richtlinie 93/42/EWG erfüllen. Es wurden die
folgenden Normen angewendet :

DIN EN 60601-1:2006/AC:2010
DIN EN 60601-1-2:2007,
DIN EN 60601-1-4:1996+A1:1999,
DIN EN 60601-2-52 :2010

Declaration of conformity

Appendix VII
EU Directive 93/42/EEC

The signatory
Völker GmbH
Wullener Feld 79
58454 Witten/Germany

with a manufacturing site at:
Völker GmbH
Ahornstraße 4
09661 Hainichen/Germany

confirms that the products described
below and in the form distributed by
ourselves meet the basic requirements of
Appendix I of EU Directive 93/42/EEC.
The following standards are applied :

DIN EN 60601-1:2006/AC:2010
DIN EN 60601-1-2:2007,
DIN EN 60601-1-4:1996+A1:1999,
DIN EN 60601-2-52:2010

Déclaration de conformité

Annexe VII
Directive EU 93/42/CEE

La soussignée
Völker GmbH
Wullener Feld 79
58454 Witten/Allemagne

avec un site de production à:
Völker GmbH
Ahornstraße 4
09661 Hainichen/Allemagne

confirme que les produits spécifiés ci-
dessous sont conformes, dans le modèle
mis en circulation, aux exigences
fondamentales de L'annexe L de la
directive européenne 93/42/CEE.
Les standards suivants sont appliqués :

DIN EN 60601-1:2006/AC:2010
DIN EN 60601-1-2:2007,
DIN EN 60601-1-4:1996+A1:1999,
DIN EN 60601-2-52:2010

CONTENTS

| | |
|---|----|
| Symbols used | 68 |
| Technical data | 69 |
| Classification | 71 |
| Type label | 72 |
| Service life / disposal | 74 |
| Manufacturer's declarations, forms, electronic instructions for use | 75 |

Appendix | Symbols used



Warning symbols

Information marked with this symbol must always be read and strictly adhered to!



Warning about the risk of crushing and entrapment!



Observe the information in the instructions for use!

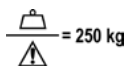

Safe working load 250 kg

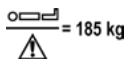

Max. permitted weight of the patient 185 kg
(in application environments 1 and 2)

9



Direct current



Alternating current



Protection class II device, protection-insulated



Type B application part as per DIN EN 60601-1



The product satisfies the fundamental requirements of Appendix 1 of EU Directive 93/42/EEC.



The product must be disposed of in accordance with EU Directive 2002/96 EC pertaining to old electrical and electronic equipment.

The following logos are country-specific:



TÜV SÜD certified
(Technical Inspection Association SÜD)



NRTL certified
(Nationally Recognized Testing Laboratory)

Appendix | Technical data (standard design) 1/2

The details marked below with * are dependent on the length, width or model of the bed. The values specified relate to model S 582 in Design S.

| | |
|---|---|
| External dimensions (W x L) | |
| for lying surface 90 x 200 cm * | approx. 99 x 213 cm |
| for lying surface 90 x 210 cm * | approx. 99 x 223 cm |
| for lying surface 100 x 200 cm * | approx. 109 x 213 cm |
| for lying surface 100 x 210 cm * | approx. 109 x 223 cm |
| Clearance height | approx. 13 cm ** |
| Height of the lower edge of lying surface frame (min./max.) * | approx. 19 cm / 74 cm |
| Height of the upper edge of the lying surface (min./max) * | approx. 25 cm / 80 cm |
| Height of upper edge of head and foot section (min./max.) * | approx. 62 cm / 117 cm |
| Lying surface (4-part) * | approx. 90 x 200/210 cm approx. 100 x 200/210 cm |
| Volumetric weight of the mattress material | 40 - 50 kg/m ³ |
| Unladen weight * | approx. 161 kg |

** From a lying surface height of 36 cm at a width of 76 cm.
The width of the clearance increases with a larger lying surface.



| | | |
|---|--|--|
| Safe working load for the bed | 250 kg | |
| Max. patient weight  9 | <u>in application environment 1, 2</u> | <u>in application environment 3, 5</u> |
| S 582 | 185 kg | 215 kg |
| Safe working load for the trapeze bar holder | 75 kg | |
| Safe working load for drip stands | 2 kg / hook | |
| Castors | 4: Ø 125 mm | |
| Max. load on castors | 150 kg (dynamic) | |

Appendix | Technical data (standard design) 2/2

| | |
|--------------------|--|
| Mains voltage | AC 230 V (EU, UK version) AC 115 V (US version) |
| Power consumption | 210 W |
| Nominal frequency | 50 Hz / 60 Hz |
| Primary fuse | 1.6 A (EU, UK version) 3.15 A (US version) |
| Overload fuse | Thermal circuit breaker 100 °C (EU, UK, US version) |
| Hand control fuse | Type: Fine fuse, slow-acting, 375 mA |
| Energy supply fuse | Type: Fine fuse, slow-acting, 2 A |
| Lifting motor fuse | Current supervision, Overcurrent trip at 18.3 A (Hardware) Overcurrent trip at 15 A (Software) |
| Battery pack | 2 x 12 V block battery (lead gel) 5.4 Ah |

| | |
|---------------------------------------|---------------------|
| Operating temperature range | + 10 °C to + 40 °C |
| Transport / storage temperature range | - 20 °C to + 60 °C |
| Air humidity | 30 % to 75 % rel. |
| Atmosphere range | 700 hPa to 1060 hPa |
| Operating volume | 52 dB(A) |
| Operating height | maximum 3000 m |

Appendix | Classification

| | |
|---|--|
| Protection against electric shock | Protection class II or device with internal electrical current source  |
| Protection type by housing as per EN 60529 | IPX4 (splashproof) not suitable for cleaning in automatic washing systems |
| Degree of protection of the applied part against electric shock as per DIN EN 60601-1 | Type B  |
| Degree of protection against explosive substances and mixtures | The bed is not protected against explosion and should not be used in an environment in which flammable anesthetics or flammable cleaning agents are present (respective national regulation) |
| Grouping/Classification as per 93/42/EEC Appendix IX | Class I |

| | |
|-------------------|--|
| Mode | 16 % (2 min./10 min.) (on-time maximum 2 minutes / off-time 10 minutes) |
| Technical control | 1x yearly |

Appendix | Type label 1/2

Type specifications

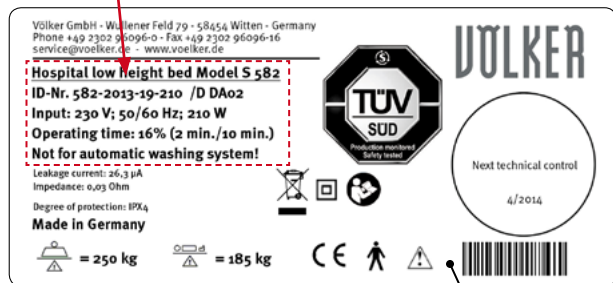

The type label is located at the head end on the inside of the frame.

Raise the back section to read the type label.

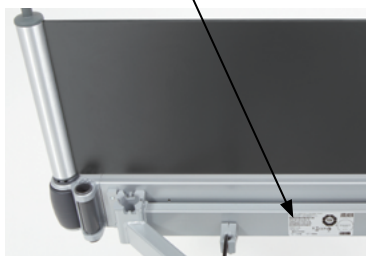

| Type specifications | Explanation |
|---------------------|---|
| 1st line | Model designation. In the example: HOSPITAL LOW HEIGHT BED Model S 582 |
| 2nd line | ID No. (made up as follows): 582 = Model -2013 = Year of construction -19 = Production week (calendar week) -210 = Consecutive number D = Mains plug version (e.g. D = Germany) DA02 = Drive version |
| 3rd line | Input: mains voltage; mains frequency; power consumption |
| 4th line | Operating time: Maximum uninterrupted on-time of electromotive adjustment. In the example 16% (2 min./10 min.) This means that the bed may be operated with the electric motor without interruption for max. 2 minutes, after which a pause of 10 minutes will be necessary (protection against overheating). |
| 5th line | Suitability for automatic washing system. In the example: Unsuitable for automatic washing system. |

Symbols used 68

Appendix | Type label 2/2

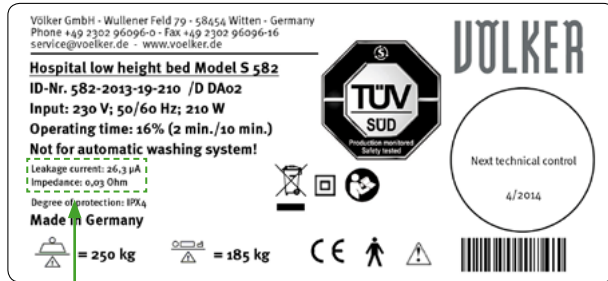

Measured values

Barcode

Measured values

- 1st line Leakage current in μA
- 2nd line Potential equalization impedance in Ω (Ohm)

The specified initial measured values were measured in accordance with EN 62353.





The barcode (code 39) contains the numeric ID No. (10 digits).

Appendix | Service life / disposal



The bed's expected service life is approx. 10 years. To ensure environmentally friendly disposal after taking the bed out of service, please contact your responsible area sales manager.

Appendix | Manufacturer's declarations, forms, electronic instructions for use

Manufacturer's declarations

- Declaration of conformity  76
- Table 201 – Guidelines and manufacturer's declaration – Electromagnetic compatibility (6.8.3.201 a) 3))  77
- Guidelines and manufacturer's declaration – Electromagnetic compatibility (6.8.3.201 a) 6))  78
- Table 204 – Guidelines and manufacturer's declaration – Electromagnetic compatibility for all devices and systems that are not life-sustaining (6.8.3.201 b))  80
- Table 206 - Recommended protected distance between portable and mobile HF telecommunications equipment and the bed – for devices and systems that are not life-sustaining (6.8.3.201 b))  83

Forms

- Technical check of Völker hospital and healthcare beds in accordance to German standards and safety regulations including measurements required  84
- Spare part order  85

Overview

- Available accessories for the model S 582  86

Electronic instructions for use

- Requirement for the use of the electronic instructions for use  89

Konformitätserklärung / Declaration of Conformity / Déclaration de conformité

Konformitätserklärung

Anhang VII
EU-Richtlinie 93/42/EWG

Der Unterzeichnende
Völker GmbH
Wüllener Feld 79
58454 Witten

mit einer Fertigungsstätte unter der Adresse:
Völker GmbH
Ahornstraße 4
09681 Hainichen

bestätigt, dass die nachfolgend bezeichneten Produkte in der von uns in Verkehr gebrachten Ausführung die grundlegenden Anforderungen des Anhangs I der EU-Richtlinie 93/42/EWG erfüllen. Es wurden die folgenden Normen angewendet :

DIN EN 60601-1:2006/AC:2010
DIN EN 60601-1-2:2007,
DIN EN 60601-1-4:1999+A1:1999,
DIN EN 60601-2-52 :2010

Damit sind die Anforderungen des Medizinproduktegesetzes zur Anbringung einer **CE Kennzeichnung** erfüllt.

Bei einer nicht mit dem Hersteller abgestimmten Änderung des Produktes verliert diese Konformitätserklärung ihre Gültigkeit.

Bezeichnung der Produkte :
Klinikinlegbretten Modell S 582.

EG-Richtlinien :
Richtlinie 93/42/EWG vom 14.06.1993 über Medizinprodukte (Anhang I „Grundlegende Anforderungen“).
Die Produkte sind Produkte der Klasse I gemäß Anhang IX der Richtlinie 93/42/EWG vom 05.09.2007.

Witten, 18.01.2013

Declaration of conformity

Appendix VII
EU Directive 93/42/EEC

The signatory
Völker GmbH
Wüllener Feld 79
58454 Witten/Germany

with a manufacturing site at:
Völker GmbH
Ahornstraße 4
09681 Hainichen/Germany

confirms that the products described below and in the form distributed by ourselves meet the basic requirements of Appendix I of EU Directive 93/42/EEC. The following standards are applied :

DIN EN 60601-1:2006/AC:2010
DIN EN 60601-1-2:2007,
DIN EN 60601-1-4:1999+A1:1999,
DIN EN 60601-2-52:2010

The requirements of the medical products law pertaining to the display of a **CE seal** of approval are hereby fulfilled.

This declaration of conformity becomes invalid if the products are altered without the agreement of the manufacturer.

Description of products Type/Article No.:
Hospital low height beds Model S 582.

EU Directives :
Directive 93/42/EEC of 14.06.1993 concerning medical products (Appendix I, Basic requirements). The design and construction of this product conforms to Class I (Appendix IX) Directive 93/42/EEC of 05.09.2007.

Déclaration de conformité

Annexe VII
Directive EU 93/42/CEE

La soussignée
Völker GmbH
Wüllener Feld 79
58454 Witten/Allemagne

avec un site de production à:
Völker GmbH
Ahornstraße 4
09681 Hainichen/Allemagne

confirme que les produits spécifiés ci-dessous sont conformes, dans le modèle mis en circulation, aux exigences fondamentales de L'annexe I de la directive européenne 93/42/CEE. Les standards suivants sont appliqués :

DIN EN 60601-1:2006/AC:2010
DIN EN 60601-1-2:2007,
DIN EN 60601-1-4:1999+A1:1999,
DIN EN 60601-2-52:2010

Les exigences de la loi sur les produits médicaux concernant le port de la **marque CE** sont ainsi satisfaites.

Cette déclaration de conformité est invalidée en cas de modification des produits, non autorisée par le fabricant.

Désignation des produits
Modèle/Référence :
Lits très bas hospitaliers modèle S 582.

Directives européennes :
Directive 93/42/CEE du 14.06.1993 sur les produits médicaux (annexe I « Exigences fondamentales »). La conception du produit est conforme à la classe I (annexe IX) Directive 93/42/CEE du 05.09.2007.



Michel Tidman

Geschäftsführer / Managing Director / Gérant

EU DECLARATION OF CONFORMITY

For the Directive 2011/65/EU (RoHS 2)

Manufacturer's Name: Völker GmbH
Manufacturer's Address: Wullener Feld 79, 58454 Witten, Germany
Name of Device: S582
Model Numbers: N/A
Serial Numbers: See product label, S582-2014-30 onwards
Classification: Category 8 Annex 1

We, the undersigned, hereby declare that the above device complies with the provisions of the Directive 2011/65/EU of the European Parliament and of the Council of 8 June 2011 on the restriction of the use of certain hazardous substances in electrical and electronic equipment (EEE). This declaration is issued under the sole responsibility of "Völker GmbH." Any modification of the equipment not authorized by "Hill-Rom, Inc." will invalidate this declaration.

This declaration is based upon:

- information provided in the product Technical File S582
- compliance with harmonized standard: EN 50581:2012, Technical documentation for the assessment of electrical and electronic products with respect to the restriction of hazardous substances

Signed for and on behalf of the manufacturer.

Signature/Unterschrift:



Name & Title/ Name und Titel:

Jörg Waldeyer, Operational managing director and Management representative MWER

Date: July 22nd, 2014/ Datum: 22.Juli 2014

EU KONFORMITÄTS-ERKLÄRUNG

Zur Richtlinie 2011/65/EU (RoHS 2)

Herstellername: Völker GmbH
Adresse des Herstellers: Wullener Feld 79, 58454 Witten, Germany
Benennung des Produktes: S582
Model-Nummer: N/A
Seriennummer: Siehe Produktkennzeichnung, S582-2014-30 aufwärts
Klassifizierung: Kategorie 8 Annex 1

Mit der Unterschrift bestätigt die Firma Völker GmbH, dass die genannten Produkte die Anforderungen der 2011/65/EU des Europäischen Parlaments und dem Ausschuss vom 08.Juni 2011 über den eingeschränkten Gebrauch gesundheitsgefährdender Substanzen in elektrischen oder elektronischen Produkten (EEE). Diese Erklärung wird unter der alleinigen Verantwortung der Völker GmbH herausgegeben. Jede Änderung an den Produkten, die nicht von der Völker GmbH freigegeben wurde, lässt die Gültigkeit dieser Erklärung erlöschen. Diese Erklärung wird auf der Grundlage der folgenden Unterlagen abgegeben:

- Information in der Produktakte (Technical File) zu dem Produkt S582
- Erfüllung der harmonisierten Norm EN 50581:2012, technische Dokumentation über die Untersuchung der elektrischen oder elektronischen Produkte bezüglich der Einschränkungen für die Anwendung gesundheitsgefährdender Stoffe.

Als Bevollmächtigter des Unternehmens unterschrieben durch:

Table 201 - Guidelines and manufacturer's declaration - Electromagnetic compatibility**(6.8.3.201 a) 3))**

The bed is intended for use in the electromagnetic environment as described below. The customer or user of the bed should ensure that it is used in such an environment.

| Emissions measurements | Conformity | Electromagnetic environment - guideline |
|---|-------------------|--|
| HF emissions DIN EN 61000-3-2 | Class A | The bed is suitable for use in all institutions, including residential areas and such that are directly connected to a public mains supply network that also supplies buildings intended for residential purposes. |
| Fluctuations in voltage / flicker DIN EN 61000-3-3 | Conforms | |
| RF emissions CISPR 14 – 1 | Conforms | The bed is not suitable for connection to other equipment. |

Guidelines and manufacturer's declaration - Electromagnetic compatibility (6.8.3.201 a) 6)

The bed is intended for use in the electromagnetic environment as described below. The customer or user of the bed should ensure that it is used in such an environment.

| Compatibility check | DIN EN 60601 Testing level | Conformity level | Electromagnetic environment - guideline |
|---|---|--|---|
| Discharge of static electricity (ESD) DIN EN 61000-4-2 | ± 6 kV contact discharge ± 8 kV air discharge | ± 6 kV contact discharge ± 8 kV air discharge | The ground should be made of wood or concrete and be laid with ceramic tiles. If the ground is covered with synthetic material, the relative air humidity must be at least 30%. |
| Rapid transient electrical disturbance / bursts DIN EN 61000-4-4 | ± 2 kV for voltage supply ± 1 kV for input and output cables | ± 2 kV for voltage supply Not applicable | The quality of the voltage supply should be commensurate with a typical commercial or hospital environment. |
| Surge voltages DIN EN 61000-4-5 | ± 1 kV series mode voltage ± 2 kV common-mode voltage | ± 1 kV series mode voltage Not applicable | The quality of the voltage supply should be commensurate with a typical commercial or hospital environment. |

 *Continued on next page*

| Compatibility check | DIN EN 60601 Testing level | Conformity level | Electromagnetic environment - guideline |
|--|---|---|--|
| Voltage drops, short interruptions and voltage fluctuations in the mains voltage supply DIN EN 61000-4-11 | <p>< 5 % U_T (>95 % voltage peaks in U_T) for 0.5 cycles</p> <p>40 % U_T (60 % dip in U_T) for 5 cycles</p> <p>70 % U_T (30 % dip in U_T) for 25 cycles</p> <p>< 5 % U_T (>95 % dip in U_T) for 5 sec</p> | <p>< 5 % U_T (>95 % voltage peaks in U_T) for 0.5 cycles</p> <p>40 % U_T (60 % dip in U_T) for 5 cycles</p> <p>70 % U_T (30 % dip in U_T) for 25 cycles</p> <p>< 5 % U_T (>95 % dip in U_T) for 5 sec</p> | <p>The quality of the voltage supply should be commensurate with a typical commercial or hospital environment.</p> <p>If the user requires continued function from the bed when interruptions in the power supply occur, it is recommended that the bed be powered via an uninterruptible power supply or a battery.</p> |
| Magnetic field at supply frequency (50/60 Hz) DIN EN 61000-4-8 | 3 A/m | 3 A/m | Magnetic fields at mains frequency should correspond to the typical values present in commercial and hospital environments. |
| Remark 1: U_T is the mains AC voltage before the testing level is applied. | | | |

**Table 204 – Guidelines and manufacturer's declaration – Electromagnetic compatibility
for all devices and systems that are not life-sustaining (6.8.3.201 b))**

The bed is intended for use in the electromagnetic environment as described below. The customer or user of the bed should ensure that it is used in such an environment.

| Compatibility check | DIN EN 60601 Testing level | Conformity level | Electromagnetic environment - guideline |
|---|-----------------------------------|-------------------------|--|
| Conducted HF disturbances DIN EN 61000-4-6 | 3 Vrms 150 kHz to 80 MHz | 3 V | |

 *Continued on next page*

| Compatibility check | DIN EN 60601 Testing level | Conformity level | Electromagnetic environment - guideline |
|--|--------------------------------|------------------|---|
| Radiated HF disturbances DIN EN 61000-4-3 | 3 V/m 80 MHz to 2.5 GHz | 3 V/m | <p>Portable and mobile radio equipment should not be used any closer to the bed, or their cables, than the recommended protective distance which is calculated based on the equation applicable for the transmission frequency.</p> <p>Recommended protective distance</p> $d = 1.17 \sqrt{P} \quad 150 \text{ kHz to } 80 \text{ MHz}$ $d = 1.17 \sqrt{P} \quad 80 \text{ MHz to } 800 \text{ MHz}$ $d = 2.33 \sqrt{P} \quad 800 \text{ MHz to } 2.5 \text{ GHz}$ <p>Where P is the rated output of the transmitter in Watts (W) as specified by the transmitter manufacturer and d is the recommended protective distance in metres (m).</p> <p>The field strength of stationary radio transmitters should be less than the conformity level^b at all frequencies, as verified by an on-site test^a.</p> <p>Disturbance is possible in the environment of equipment that bears the following label.</p>  |

 Continued on next page.

Remark 1: At 80 MHz and 800 MHz, the higher frequency range applies.

Remark 2: These guidelines may not be applicable in all cases. The spread of electromagnetic parameters is influenced by the absorption and reflection of buildings, objects and people.

^a The field strength of stationary transmitters, such as base stations of cordless telephones and mobile land radio, amateur radio stations, AM and FM radio and TV stations cannot be quantified in theory in advance accurately. To determine the electromagnetic environment in relation to a stationary transmitter, a study of the site should be considered. If the measured field strength at the site where the bed is used exceeds the conformity levels stated above, the bed should be observed to ensure that it functions correctly. If unusual features are observed, additional measures may be required, such as modified alignment or a different location for the bed.

^b In the frequency range from 150 kHz to 80 MHz, the field strength should be less than 3 V/m.

Table 206 - Recommended protective distance between portable and mobile HF telecommunications equipment and the bed – for devices and systems that are not life-sustaining (6.8.3.201 b))

The bed is intended for operation in an electromagnetic environment in which HF disturbances are controlled. The customer or user of the bed can help to avoid electromagnetic disturbances by respecting the minimum distance between portable and mobile HF telecommunications equipment (transmitters) and the bed. The recommended minimum distance d is dependent on the maximum power output of the communication device (see below).

| Rate output of the transmitter W | Protective distance according to the frequency of the transmitter m | | |
|---------------------------------------|--|-----------------------------------|------------------------------------|
| | 150 kHz to 80 MHz $d = 1.17 P$ | 80 MHz to 800 MHz $d = 1.17 P$ | 800 MHz to 2.5 GHz $d = 2.33 P$ |
| 0.01 | 0.12 | 0.12 | 0.23 |
| 0.1 | 0.37 | 0.37 | 0.74 |
| 1 | 1.17 | 1.17 | 2.33 |
| 10 | 3.69 | 3.69 | 7.38 |
| 100 | 11.67 | 11.67 | 23.33 |

For transmitters whose maximum rated output is not specified in the table above, the recommended protective distance d in metres (m) can be calculated using the equation in the column that features P as the maximum power output of the transmitter in Watts (W) as defined by the transmitter manufacturer.

Remark 1: At 80 MHz and 800 MHz, the higher frequency range applies.

Remark 2: These guidelines may not be applicable in all cases. The spread of electromagnetic parameters is influenced by the absorption and reflection of buildings, objects and people.

Technical check of Völker hospital and healthcare beds in accordance to German standards and safety regulations incl. measurements required



| Project, address, customer no.: | Name of technician: | | | | |
|---|--|--|----------|--------------|----------------|
| Type of bed, product, location of the bed: | Component to be checked | Annually | Accepted | Not accepted | Not applicable |
| Bed identification (e.g. facilities own identification or Völker ID-no.): | Inscription on device readable | | | | |
| Date of check: | Instructions for use available | | | | |
| Kind of check | Visual inspection | Base frame | B* | | |
| | | Lying surface, wing and spring elements (if existing) | B* | | |
| | | Trapeze bar adapter, infusion bar adapter | B* | | |
| | | Power supply cable, plug or charger, changing connection | B* | | |
| | | Strain relieve, bend protection, cable hook | B*/S* | | |
| | | Connecting cable, plug-in contacts, blind plugs | B*/S* | | |
| | | Positioning (spacing 1 mm) and sensor cabling (only Vis-a-Vis-bed) | B*/S* | | |
| | | Housing (motor, control electronics) | B* | | |
| | | Hand control (housing, cable) | B* | | |
| | | Nurse keypad, nurse hand control (housing, cable) | B*/F* | | |
| | | Trapeze bar, assist rail infill panel (side rail centre), additional accessories | B* | | |
| | | Transverse motors and cover, head and foot ends | B* | | |
| | | Casters | B* | | |
| | | Wail buffer wheel (if existing) | B* | | |
| Side rails including telescopic section, if applicable | B* | | | | |
| Functional inspection of side rails including telescopic section, if applicable | Side rails including telescopic section, if applicable | B* | | | |
| Locking devices | Locking devices | S* | | | |
| Low-elevation, check screw locking (only for 5380) | Low-elevation, check screw locking (only for 5380) | S* | | | |
| Deformation | Deformation | X* | | | |
| Abrasions | Abrasions | X* | | | |
| Functional inspection of drives with hand control and nurse keypad/nurse hand control | Back section, upper leg section, lower leg section, height adjustment, Trendelenburg position, reverse Trendelenburg position, length adjustment (only for Vis-a-Vis-bed) - approach all end positions | X*/M* | | | |
| | Angle limitation (back section to upper leg section >90°) | X* | | | |
| | Adjustment lower leg section (automathydraulik/support plate) | X* | | | |
| | CPR function (if existing) | X* | | | |
| | Brake (electrical or mechanical) | X* | | | |
| | - brake applied | | | | |
| | - free running | | | | |
| | (only for hospital beds and clearing position S 280/S 310/S 360/S 262/S 362 (Vis-a-Vis)) | | | | |
| Functional inspection replacement | Mechanical release (only for electrical brakes of hospital beds) | X* | | | |
| | 9 V battery (only for beds with Oxi-/floodmat except S 960-1WS 961) | A2* | | | |
| | Replaced (yes/no) | | | | |
| | Trapeze bar handle and belt (if existing) | A* | | | |
| Functional inspection miscellaneous | Bed extension (if existing) | B* | | | |
| | Bedding storage/loading drawer (if existing) | B* | | | |
| | Inspection of the adhesive joints on headboard and footboard (if existing) | B* | | | |
| Comment | | | | | |
| Legally relevant for Germany only (according to DIN EN 62933) | Leakage current by means of alternative measurement ≤ 500 µA | | µA | | |
| | Potential equalization impedance < 0,2 Ohm (if existing) | | Ω | | |
| | Measuring instrument SIN | | | | |
| Total result of the inspection: | | Next regular inspection: | | | |
| Signature of technician: | | | | | |

A*: To be replaced every 6 years for hospital (HS) and for H with roll function (RF) in hospital/rocker, every 3 years for H with RF in hospital/rocker, every 2 years for H with RF for clearing in automatic bed washing systems. A2*: To be replaced every 6 years. B*: Check for damage. F*: Check for deformation. M*: Check function of motors and end switches, does the motor switch off when reaching the end position? S*: Check for correct fit. X*: General function control

Spare Part Order/Repair Order

Spare part order

Repair order

Völker GmbH
Service
Wullener Feld 79
58454 Witten/Germany



Address: _____

Contact person: _____

Street address: _____

Zip code/city/country: _____

Telephone number: _____

Customer number: _____

Customer order number: _____

Purchase order date: _____

Signature: _____

(Please, to fill in the form use block letters)

Stamp



Tel.: +49 2302 96096-0
Fax: +49 2302 96096-66
E-Mail: service@voelker.de

Shipping address, if differently from the billing address

Address: _____

Street address: _____

Zip code/city/country: _____

Attention of: _____

Please, fill out all information carefully and complete in the form, otherwise we have problems in delivery and processing this order.

| MODEL <small>(Bed-type)</small> | SERIAL NO./YEAR OF MANUFACTURE <small>(identification label inside of the bed-head)</small> | SPARE PART DESCRIPTION/ERROR DESCRIPTION | ITEM NUMBER | QUANTITY | LOCATION OF THE BED <small>(only for repair order)</small> |
|------------------------------------|--|--|-------------|----------|---|
| | | | | | |
| | | | | | |
| | | | | | |
| | | | | | |
| | | | | | |
| | | | | | |
| | | | | | |
| | | | | | |

Contact person / telephone number for repair orders: _____

(Please, to fill in the form use block letters)

00209-EN-27 07 2017

The Völker GmbH inform you, that within the warranty period damages on the devices will be charged by us, if we detect non-intended use.

Available accessories for the model S 582 1/3

| Reference | Name | Model S 582 |
|---------------------|---|----------------|
| PZP-3060 | Trapeze bar with grab handle (consists of trapeze bar BG6182 and grab handle KT2099-01) | • |
| ZK-936/1 | Trapeze bar with handle | • |
| ZK-936/1 C | Trapeze bar with handle | • |
| ZK-936/2 | Trapeze bar with groove and handle | • |
| PZP-3060/2 | Trapeze bar with grab handle incl. roll function (consists of trapeze bar BG6182 and grab handle KT2212-03) | • |
| ZK-936/3 | Trapeze bar with handle with quick adjust | • |
| ZK-936/3 C | Trapeze bar with handle with quick adjust | • |
| Dokumentenhalter MR | File holder with X-ray compartment | • |
| Dokumentenhalter OR | File holder without X-ray compartment | • |
| ZK-969/2 | Assist rail infill panel HPL | • |
| ZK-969/3 | Assist rail infill panel HPL with cut-outs | • |
| ZK-983/2 | Mounting bar | • |
| ZP-3051/4 | Restraint mount | • |
| ZK-965 | Crutch holder | • |
| ZK-965/2 | Crutch holder | • |
| ZK-979 | Assist rail infill panel holder | • |
| ZK-1044/3 | Hand control holder (flexible) | • |
| ZK-978/2 | Towel holder | • |
| ZP-3055/2 | Infusion holder for trapeze bar for PZP-3060 | • |
| ZK-937/3 | IV holder for ZK-936/1 | • |
| ZK-937/2 | IV holder for ZK-936/2 | • |

Available accessories for the model S 582 2/3

| Reference | Name | Model S 582 |
|---------------|--|----------------|
| ZK-939 R | IV pole | • |
| ZK-939 ROV | IV pole | • |
| ZK-939 UOV | IV pole | • |
| ZK-939 S | IV pole | • |
| ZK-939 U | IV pole | • |
| ZK-1091 | Rail complying with ISO standard | • |
| ZP-1083 | Rail complying with ISO standard | • |
| ZP-1083/2 | Rail complying with ISO standard | • |
| ZK-950 R | Name plate | • |
| ZK-1084 | Rail standard | • |
| ZK-948 | Voltage compensator cable | • |
| ZK-962/2 | Writing surface | • |
| ZK-982 | Assist rail spacer cover | • |
| ZK-1088 | Pivoting accessory rail | • |
| ZK-N.N. | Assist rail height extension for lying surface 2,00 m with bumper 37 cm | • |
| ZK-N.N. | Assist rail height extension for lying surface 2,10 m with bumper 37 cm | • |
| ZK-991 2.0 | Assist rail height extension for lying surface 2,00 m with bumper 40 cm | • |
| ZK-991 2.1 | Assist rail height extension for lying surface 2,10 m with bumper 40 cm | • |
| ZK-992 2.0 | Assist rail height extension for clipping for lying surface 2,00 m (height 8 cm) | • |
| ZK-992 2.1 | Assist rail height extension for clipping for lying surface 2,10 m (height 8 cm) | • |
| ZK-981 EN 2.0 | Assist rail pads with height extension (37 cm) for lying surface 2,00 m | • |

Available accessories for the model S 582 3/3

| Reference | Name | Model S 582 |
|---------------|---|----------------|
| ZK-981 EN 2.1 | Assist rail pads with height extension (37 cm) for lying surface 2,10 m | • |
| ZK-981 E 2.0 | Assist rail pads with height extension (40 cm) for lying surface 2,00 m | • |
| ZK-981 E 2.1 | Assist rail pads with height extension (40 cm) for lying surface 2,10 m | • |
| ZK-981 2.0 | Assist rail pads for lying surface 2,00 m | • |
| ZK-981 2.1 | Assist rail pads for lying surface 2,10 m | • |
| ZK-1089 | Transducer holder | • |
| ZK-943 | General purpose hook | • |
| ZK-940/3 | Urine bottle basket | • |
| ZK-1040/2 | Urine bottle basket | • |

Requirement for using the electronic instructions for use

In order to open the electronic version of these operating instructions (PDF file), you must have Adobe Reader 5.0 or later (or the corresponding Adobe Acrobat version or another program for viewing PDF files) installed on your computer.

Adobe Reader is available for nearly all operating systems. The newest version can be obtained free of charge by download from <http://get.adobe.com/uk/reader/> .

The electronic version of these instructions for use may be found on the Internet at www.voelker.de.

Trademarks

Adobe, Acrobat and Reader are protected or registered trademarks of Adobe Systems Incorporated.

Windows is a registered trademark of the Microsoft Corporation.

VÖLKER

Völker GmbH

Wullener Feld 79 · D-58454 Witten/Germany

Phone +49 2302 960 96-0 · Fax +49 2302 960 96-16

www.voelker.de · info@voelker.de