

DÖLKER



Instructions for Use
S 964 Hospital Bed

Version, Legal Notice

**G172 Instructions for use
Rev. 1 (02.2018)
for Völker S 964 hospital bed
from year of manufacture 12/2017**

© by Völker GmbH 

Manufacturer:
Völker GmbH
Wullener Feld 79, 58454 Witten
GERMANY

Tel.: +49 2302 96096-0
Fax: +49 2302 96096-16
e-mail: service@voelker.de
website: www.voelker.de

All rights reserved. Reprinting, whether in full or in part, is not permitted.

We reserve the right to make changes due to technical developments.

The contents of this document are subject to change without prior notice.

Customers are advised to contact the relevant contact person before placing an order.

Technical documentation can be made available on request.

You will find the electronic version of these instructions for use in PDF format online at www.voelker.de.

Table of Contents 1/2

Version, Legal Notice	3	Bringing into service	28	Hand control The under-bed light	46
Table of Contents	4	General operating instructions	29	Hand control	
Type plates	6	Preparation	30	Setting the comfort seating position	47
		Electrical commissioning	31	Hand control	
Notes	7	Use of the battery	32	Setting the bed egress aid	48
General information	8	Use of the battery and taking		Hand control Setting	
Designated purpose	9	the bed out of service	33	a horizontal lying surface position	49
General provisions, user		Function check	34	Nurse keypad	
qualifications/training,				Adjusting the upper leg section	50
other requirements	11	Operation	35	Nurse keypad	
General safety instructions	12	Side rails General safety		Adjusting the back section	51
		instructions	36	Nurse keypad	
		Side rails	37	Adjusting lying surface height	52
Functional description	16	Hand control Operating the		Nurse keypad	
Overview	17	hand control, nurse keypad	39	Setting the Trendelenburg positions	53
E2508 patient hand control	18	Hand control		Nurse keypad Setting and storing	
E2507 patient/nurse hand control	19	Adjusting the back section	40	the comfort seating position and	
E2509 nurse keypad	20	Hand control		the bed egress aid	54
Mattresses	21	Adjusting the upper leg section	41	Nurse keypad	
Trapeze bar and accessory holder	22	Hand control		Switching the under bed light	
Rail infill panels	24	Adjusting the lower leg section	42	on/off, washing system position	55
Configurations	25	Hand control		Rapid lowering of the back	
		Adjusting the lying surface height	43	section/ CPR function	56
		Hand control Setting		Bed extension	57
		the reverse Trendelenburg position	44	Castors	58
		Hand control			
		Setting the Trendelenburg position	45		

Cleaning and disinfection	59	Troubleshooting	68
Cleaning	60	Table of faults	69
Disinfection by wiping	60		
Spray lances and washing systems	61	Appendix	71
Cleaning hand control units/keypads	61	Symbols used	72
		Technical data	73
		Classification	74
		Service life / disposal	75
Maintenance	62	S 964 dimension sheet	76
Staff qualifications, safety instructions	63	Side rail dimension sheets	77
Maintenance schedule	64	Guidelines and manufacturer's declaration – electromagnetic immunity	80
		Forms	84
Technical check	65		
Visual inspection	66		
Side rail function inspection	66		
Brake function inspection	67		
Drive function inspection	67		
Mains cable	67		
Wiring	67		
Casing	67		
Mechanical inspection	67		
Checking the handle	67		
Other accessories	67		

Type labels

The type labels are located on the inside of the head panel.

Raise the back section to read the type labels.

The type labels shown on this page are examples only.

For symbols used, see p. 72

Please read the notes and follow the instructions for use for the mattresses!

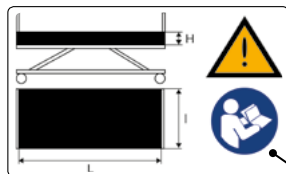

The ID no is structured as shown below:

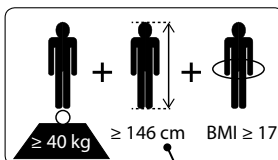
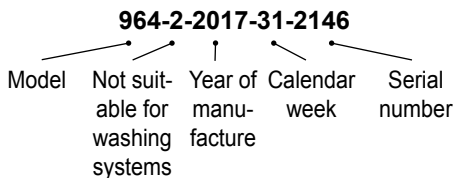

Description of an adult

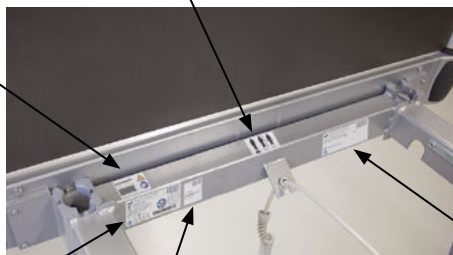

Mass of the mobile medical device inc. safe working load

Type specifications

Type specifications	Explanation
Line 1	Model name. In the example: Model S 964
Line 2	ID number
Line 3	Input: voltage; mains frequency; power consumption
Line 4	Service life: maximum continuous duty cycle of the electromotive displacement. In the example: 2 min/18 min
Line 5	Washing system suitability. Example: not suitable for washing systems
Line 6	Degree of protection in accordance with DIN EN 60525: IPX 4, splash-proof

Measured values

Measured values	Explanation
Line 1	Leakage current: In the example: 4.4 µA
Line 2	Impedance: in the example: 0.01 Ohm

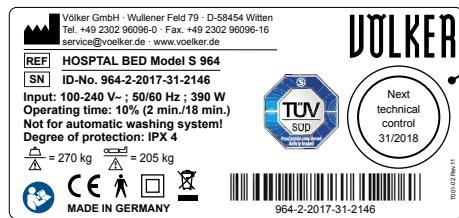

Type specifications



Measured values

The **Notes** section contains information on intended use and general safety instructions.

CONTENTS

General information	8
Designated purpose	9
General provisions, user qualifications/training, other requirements	11
General safety instructions	12

Notes | General information

General information

You have purchased a bed from Völker GmbH. This bed was constructed in conformity with the applicable national and international standards and regulations and in accordance with the current state of the art.

Völker beds meet the safety and functionality requirements. They are tested in accordance with harmonised standards and bear the CE mark documenting that the essential requirements for medical devices have been met (DIN EN 60601-1 and DIN EN 60601-2-52).

Please read the general safety instructions (p.12). Please also observe the further notes on the pages which follow (particularly with regard to any warranty claims).

Configurations

The bed can be supplied in various configurations. For a description of all configurations, please refer to the “Configurations” section (p. 25).

Copyright

The instructions for use may be handed to third parties only with the written consent of Völker GmbH. All documents are protected under copyright law.

Warranty and liability

We provide a 2-year warranty on all our products. This is described in the order confirmation.

We reserve the right to make technical changes without prior notice as part of further development of the beds referred to in these instructions for use.

All information is non-binding. Subject to printing errors.

We accept no liability for any damage or malfunction caused by operator error or failure to comply with these instructions for use.

The illustrations in these instructions for use do not necessarily correspond to the technical design.

Intended use

The Völker S 964 bed is suitable for use in hospitals and care facilities. The bed is not suitable for care in the home.

Certain types of care environments (e.g. psychiatric units, prison units, paediatrics) may have special requirements for the type of patient.

The use of the bed in these environments must be assessed by the operator.

The S 964 bed may be used in application environments 1, 2, 3 and 5 in accordance with DIN EN 60601-2-52.

The bed is intended for adult patients in the weight range of 40 – 195 kg, with a height of 146 – 185 cm (without bed extension) and with a body mass index (BMI) of 17 or more.

BMI is an index value derived from body weight and height.

BMI is calculated using this formula:

$$\text{BMI} = \frac{\text{body weight} \left[\frac{\text{kg}}{\text{m}^2} \right]}{\text{Height}^2}$$

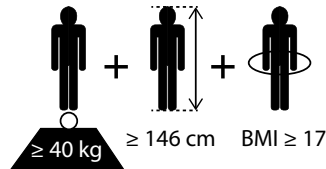

The safe working load of the bed is 270 kg.

To calculate maximum patient weight in accordance with DIN EN 60601-2-52, in application environments 1 and 2 (intensive and acute care) 20 kg must be deducted from the safe working load for the weight of the mattress, along with 45 kg for the accessories and the load they bear.

When the bed is used in application environments 3 and 5 (long-term and outpatient care), the values to be taken into account are 20 kg for the mattress and 15 kg for the accessories and the load they bear.

Any use of the Völker bed which deviates from this designated purpose is excluded from potential liability.

Maximum patient weights are summarised in the following table.

Model S 964	
Safe working load: 270 kg	
Maximum patient weight	
In application environments 1, 2	In application environments 3, 5
205 kg	235 kg

Notes | Designated purpose 2/2

Improper use

Improper use may result in hazards.

For example, these may include:

- electrical functions being operated improperly and uncontrolled positioning
- the patient operating the bed without prior instruction
- pulling on cables to move the bed
- pulling on cables to disconnect electrical connectors
- the bed being used on sloping surfaces with an incline of more than six degrees (the bed brakes are designed for tilt angles of maximum ten degrees)
- attempting to move the bed with the brakes applied
- using the bed to transport a patient in a vehicle
- overloading the bed beyond its specified safe working load



CAUTION If, in the event of an emergency, children under 12 years of age or persons under 146 cm in height have to be put in the beds, the protective covers for the side rails must be used. This also applies when the bed is used by weak or confused persons. Use for children under 8 years of age is not permitted under any circumstances.



WARNING The bed must not be placed directly adjacent to other devices, or stacked up with them. If operation near to or stacked with other devices is necessary, it should be ensured that bed operation is monitored and that the intended use in the arrangement used is verified.

Notes | General provisions, user qualifications/training, other requirements

General provisions

The bed may be operated and used only in accordance with its designated purpose and in compliance with the applicable regulations, the generally accepted rules of technology as well as the occupational safety and accident prevention regulations. The bed must not be operated when faulty, as it could endanger patients, care staff or third parties.

User qualifications

The bed may be operated only by persons who can guarantee proper handling based on their education/training or knowledge and experience.

User training

Völker GmbH or its representatives will provide a basic introduction to operating the bed for care staff at the customer's request. Participation in such training by care staff can be confirmed in a form provided for this purpose and authenticated by Völker GmbH with name, date and signature.

Patients are to be instructed in the use of the bed by care staff before the hand control is activated.

Other requirements

Anyone tasked with bringing into service, operating or preparing the bed must have these instructions for use (on paper or in electronic form) and must have read them.

To avoid operating errors and to ensure the smooth operation of the bed, the following safety instructions must always be accessible to care staff.

Setup conditions

The bed is approved for operation in dry rooms only (see Technical data section). To operate the bed in the setup room, a power supply and, if necessary, a potential equalisation terminal, are required. If this is available and permitted by the in-house installation, it is recommended that the bed be connected to potential equalisation.

Flooring prerequisites

In recent years, as patients and residents have become heavier, demands on hospital and care beds have increased steadily. Völker has tackled this issue by raising the safe working load of the beds. However, it is not only the beds which are exposed to higher loads, but also statics and flooring.

For this reason, we recommend that flooring designed for these loads is used in areas where the beds are situated.

In accordance with DIN EN 685, these are floors classified as at least class 32 or 33 and laid by professionals. This means flooring for public areas, or areas with a commercial use, with medium or heavy traffic.

Flooring corresponding to the above classification may be marked with the following logo:

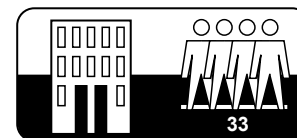



Notes | General safety instructions 1/4

 **Warning signs**
Information marked with this symbol must be read and strictly observed.

 **CAUTION** means potentially dangerous situations which could cause minor injury.

 **DANGER** means an imminent danger which could cause serious injury or death.

 **WARNING** means potentially dangerous situations which could lead to serious injury or death

 **NOTE** warns of possible material damage.

Before bringing the bed into service for the first time

Before the bed is brought into service for the first time, these instructions for use must be read in detail by care staff.

Before the bed is brought into service, care staff must be instructed in handling the bed in accordance with the instructions for use. In addition, any potential hazards which may arise despite proper operation of the bed must be pointed out in detail.

Before and during use

Before each use of the bed, the user must be convinced that it is in good condition and that safe use is guaranteed (function check, p. 34).

 **WARNING** If other devices provided with cables, air hoses or similar are required to operate on the bed, it is important to ensure that these cables are routed so that they do not become trapped in the bed's moving parts and so damaged.

Bed position

 **CAUTION** To avoid injury from falls, we recommend that the bed is moved with the castors fixed in the lowest position when the patient is sleeping in the bed (except when undertaking care measures).

Transporting the bed

-  **CAUTION** When transporting the bed, it is important to ensure that the mains cable does not come into contact with the ground and that the lying surface height is at least 40 cm. The bed should be moved on a solid surface only. Do not attempt to push it over obstacles with a height of more than 2 cm. The maximum angle of inclination of the floor must not exceed 6°.

Securing the bed

-  **CAUTION “Risk of accident”** If the bed is not being transported, the castors must always be secured and, where appropriate, locked, since the bed may be used as support by the patient when standing up or lying down. If the bed rolls away due to unbraked castors, a serious fall could ensue. After the castors have been secured, check to ensure that the bed is actually stationary.

The bed may also be in an unbraked position after being put or brought back into service, and it should therefore be checked subsequently that the castors are properly secured.

-  **NOTE** Please note that the brakes are most effective on dry, clean and non-slip floors only.

One-sided bed load

-  **NOTE** To prevent bed load on one side only, nobody except the patient may sit on it (visitors must not sit on the edge of the bed).

Side rails

-  **WARNING “Pinch hazard”** For patients whose physical or mental condition makes it necessary to use the side rails to prevent them from falling out of bed, observe the safety measures below.

- The legal admissibility of using the side rails must be ensured.
- The side rails may be operated by trained care staff only.
- ensure that no body part is protruding through the side rails when actuating electric lying surface adjustment.
- Ensure that the side rails (or parts thereof) are either fully raised and locked or fully lowered.
- If the side rails need to be used due to the patient’s mental condition, it is important to ensure that the hand control is kept locked and out of their reach. In addition, it is strongly recommended that the side rail protective covers be used.

-  **DANGER** If the above safety measures are not observed, personal injury may ensue.

Notes | General safety instructions 3/4

Height adjustment



DANGER

“Pinch hazard between the undercarriage/floor and the bed frame when lowering the bed”

It is necessary to ensure that no persons, limbs, pets, bedding or other objects are between the bed frame and the undercarriage/floor when adjusting the bed.



DANGER “Danger of movement”

If any bed movement could constitute a hazard, all functions must be locked.

Accessories



WARNING

“Danger of injury”

Only original Völker accessories may be used, with no exceptions! The operator accepts responsibility for the use of other accessories not approved by Völker GmbH.

Use of oxygen equipment



DANGER “Risk of fire”

Do not use any oxygen equipment except masks and devices attached to the nose. Never use the bed in an oxygen tent or in potentially explosive atmospheres (presence of flammable gases or vapours).

The device may be used if the O₂ concentration, whether during use or due to a malfunction, is guaranteed not to increase to the extent that the risk of explosion arises (e.g. by means of the information in the instructions for use for the device used).

Rail infill panels

When using the assist rail spacers, please observe the separate instructions for use for this accessory. During technical checks, the assist rail spacers should be checked in relation to the dimensions of the side rails.

Cleaning and disinfection

To maintain the functionality of the bed, the bed should be cleaned, disinfected and tested as soon as possible after each use, so that it can be used again immediately and without risk.

Hazards may arise due to improper cleaning/disinfection of the bed.

Maintenance and repairs

Anyone tasked with maintenance and repair must have participated in at least one training session in the service tools with Völker GmbH, must have read the safety regulations and the service handbook and be qualified in accordance with the German Medical Devices Act, § 6.

After maintenance work or repairs have been carried out, a technical check of the affected parts or functions should be performed. During this process it should also be established whether the bed can be used without risk to patients, users or third parties in accordance with the specifications.

The technical check should be conducted at least once per year and when the bed has not been used for a long period.

Any damage, such as wear and tear, loose screws or breaks, must be remedied immediately.

Electromagnetic and electrostatic interference

Model S 964 beds meet the EMC* requirements in accordance with the Medical Devices Act (MPG). The test is based on standard DIN EN 60601-1-2.

Application parts

An application part is a part of a medical electrical device (ME device) which of necessity comes into physical contact with the patient under normal conditions of use, so that the ME device or an ME system can fulfil its function (DIN EN 60601-1).

For the S 964 hospital bed, these are:

- hand control
- side rails
- head/foot ends
- lying surfaces
- frame

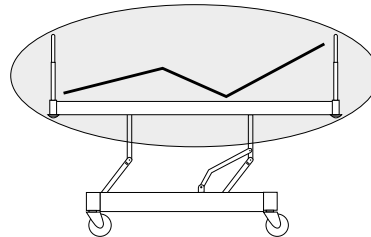

A schematic representation of the application area.

* The German Electromagnetic Compatibility of Equipment Act

Functional description

In the **Functional description** section, the performance characteristics of the bed, and their function, are presented.

CONTENTS

Overview	17
E2508 patient hand contro	18
E2507 nurse hand control	19
E2509 nurse keypad	20
Mattresses	21
Trapeze bar and accessory holder	22
Rail infill panels	24
Configurations	25

Functional description | Overview of S 964 hospital bed

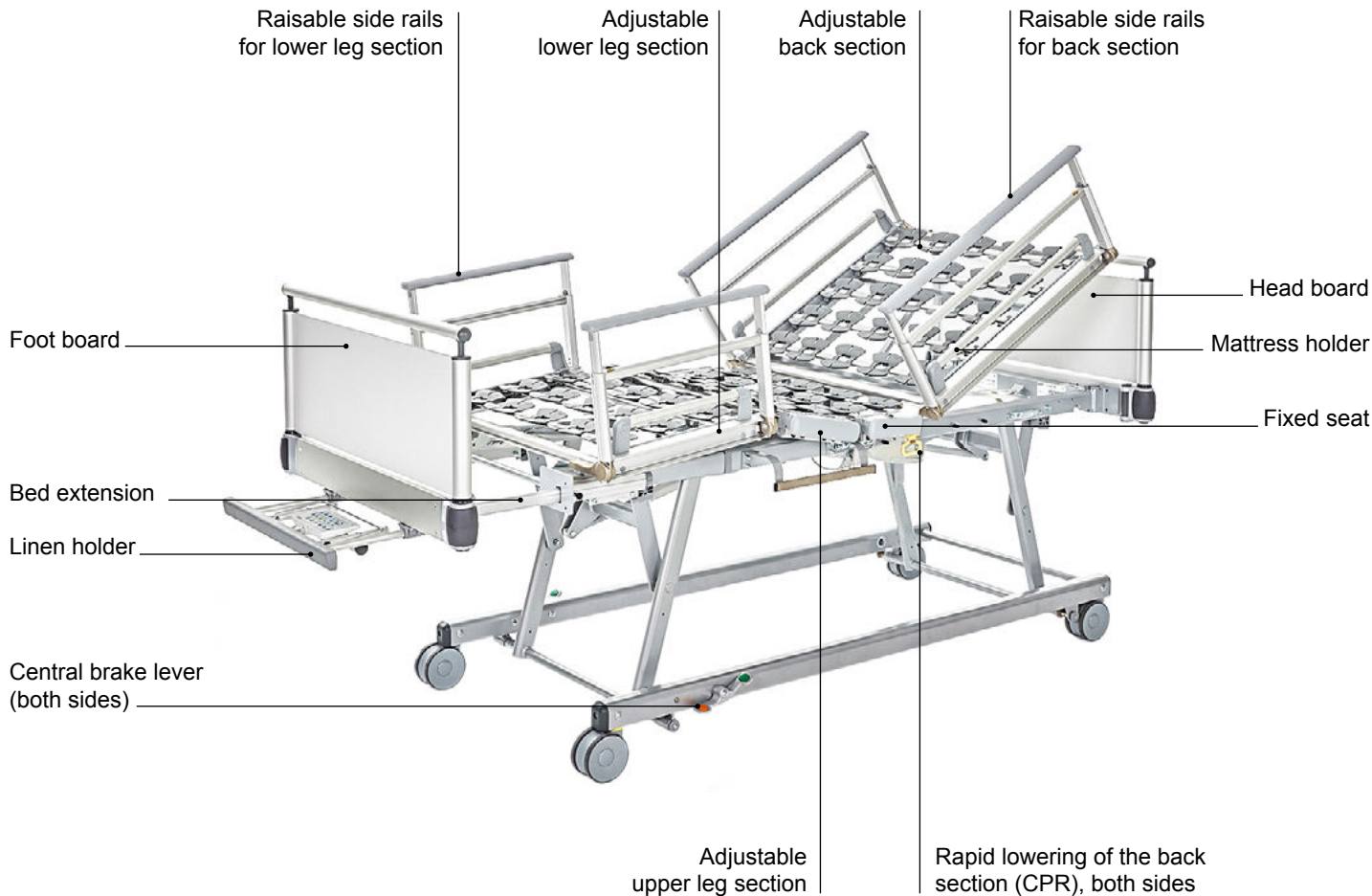

Functional description | E2508 patient hand control

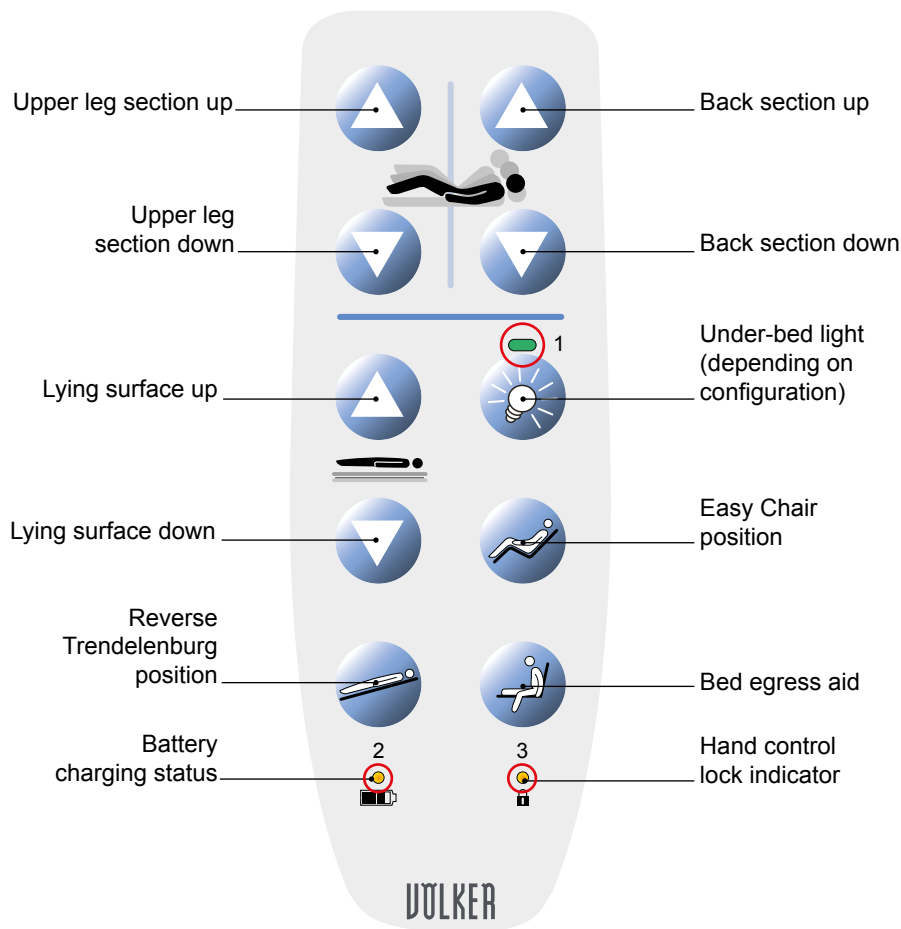

What the LEDs mean

Both the patient and nurse hand control units have LEDs to allow the user to view the different statuses of the hand control.

Under-bed light [1]

This LED is lit permanently, to make it easier to find the hand control or the under-bed light button.

Battery status [2]

This LED does not light up when the battery is sufficiently charged. When the battery is charging, the LED remains permanently lit. When the battery charge status is critical, the LED flashes when a hand control or the keypad is operated.

Hand control lock [3]

The LED is permanently lit when the hand control is locked by the magnetic key. If individual functions are locked, the LED flashes when an attempt is made to use this function.

Functional description | E2507 patient/nurse hand control

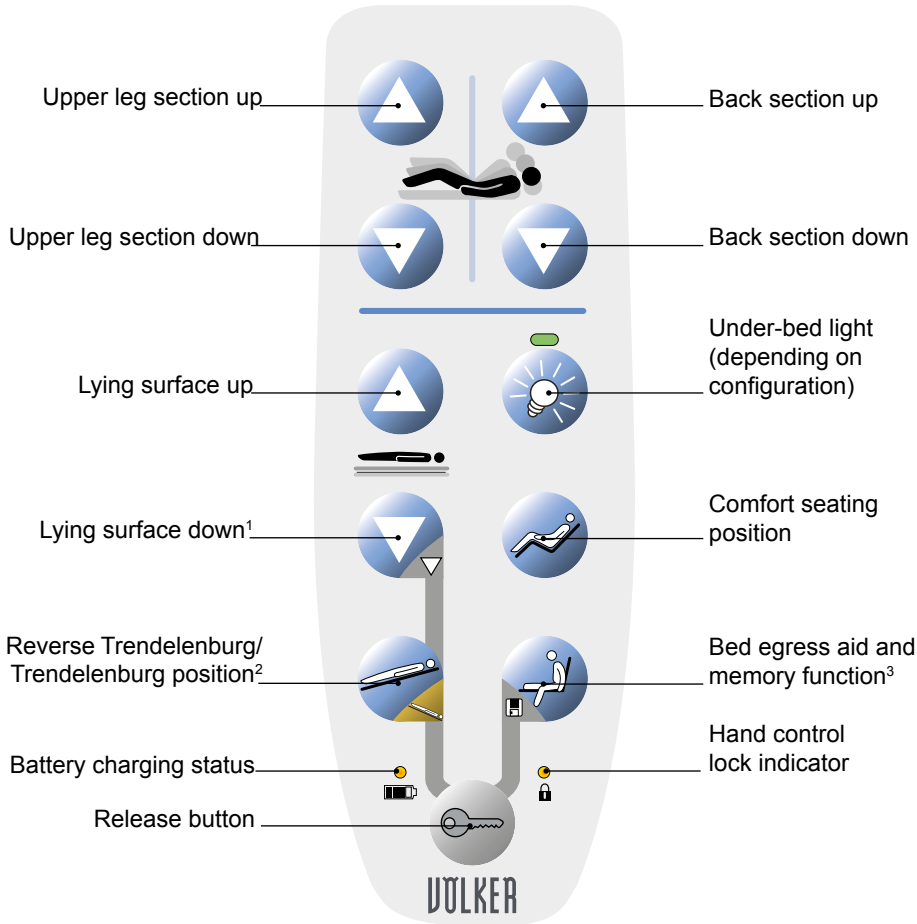

⚠ WARNING When adjusting the bed with the side rails raised, ensure both that the patient does not come into contact with the side rails and that their body parts, or those of other persons, are not protruding through the side rails or coming between the lying surface and the undercarriage/floor.

^{1, 2, 3} See the notes on p. 39 on use of the release button.

Functional description | E2509 nurse keypad

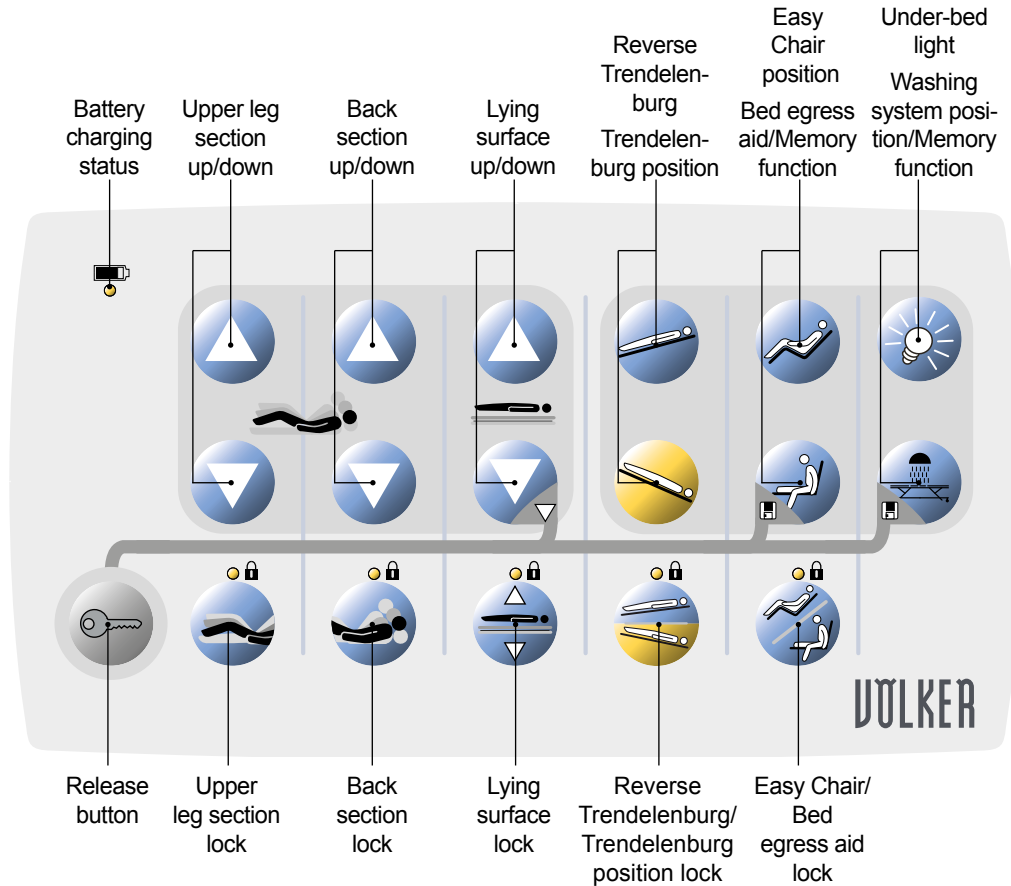

⚠ WARNING When adjusting the bed with the side rails raised, ensure both that the patient does not come into contact with the side rails and that their body parts, or those of other persons, are not protruding through the side rails or coming between the lying surface and the undercarriage/floor.

Functional description | Accessories 1/4 – mattresses

To minimise the risk of injury, use only Völker mattresses whose dimensions are matched to Völker lying surfaces.

⚠ DANGER The use of mattresses not corresponding to the specifications may lead to the risk of suffocation!

⚠ DANGER The height of the raised side rails above a mattress must always be greater than or equal to 220 mm. If not, the patient may inadvertently fall out of the bed. Please note that mattress height directly affects this.

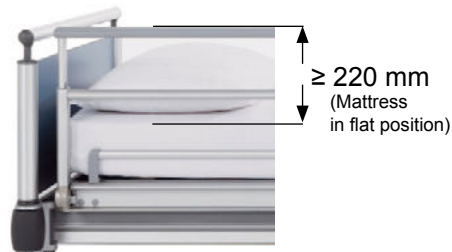

Functional description | Accessories 2/4 – accessory holders

Völker provides a wide selection of accessories for the greatest possible flexibility. The beds are fitted as standard with accessory holders for infusion stands and trapeze bars, for example. For more information regarding accessories, please refer to our current brochures or our website www.voelker.de. Our staff will be happy to tell you about the accessories available for your model of bed.

⚠ WARNING Only the trapeze bars given in the Accessories List may be used.

⚠ WARNING “Risk of Injury”
The trapeze bar must not be used by an unsupervised patient.

⚠ WARNING “Risk of Injury”
Ensure that the trapeze bar has been inserted fully into the holder and is located properly. Please note: The safe working load of the trapeze bar is a maximum of 75 kg.

Holders for accessories such as a trapeze bar are situated on the inside of the head panel.



Trapeze bar holders Ø 34 mm.



Place the trapeze bar Ø 34 mm into the holder and align it using the grooved pin.

Depending on the configuration, a holder for a patient trapeze bar with external Ø 40 mm can be affixed.

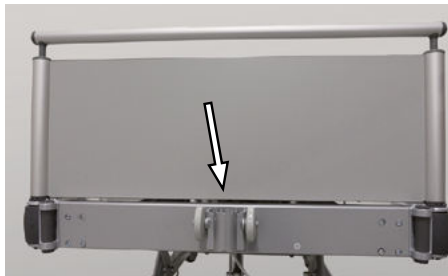

⚠ WARNING “Risk of Falling”
The trapeze bars must not protrude beyond the outer edge of the bed.



Functional description | Accessories 3/4 – accessory holders

 **WARNING** As illustrated below, the infusion stand must always face the bed and not outwards.



 **WARNING “Risk of Falling”**
The trapeze bar and infusion stand must never be used by the patient as an entry or egress aid (e.g. when getting out of a wheelchair).



Functional description | Accessories 4/4 – Rail infill panels

The rail infill panels close the central gap between the split side rails on Völker beds to create a continuous side rail solution.

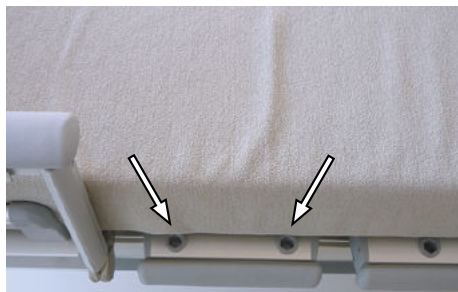

The rail infill panels are inserted into the support sleeves on the upper leg section.

Check whether the pendulum lock is fully engaged by attempting to pull the assist rail spacers out upwards. If this succeeds, push the rail infill panel completely down again and adjust the pendulum until the assist rail spacer can no longer be pulled out.

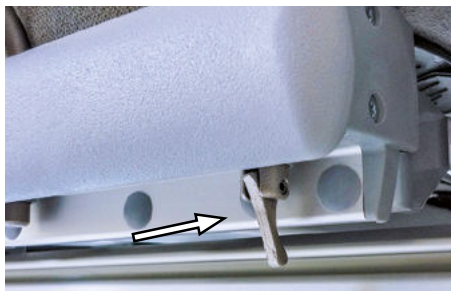

To remove the rail infill panels from the holder, move the pendulum into a vertical position and at the same time pull the assist rail spacer upwards and out.

NOTE Please note the detailed instructions for use for the rail infill panels.

WARNING Make sure that the side rails are fully raised and engaged. When operating the electric lying surface adjustment or the side rails, ensure both that the patient has no contact with the side rails and that no body parts are protruding through the side rails. Locking the hand control functions is expressly recommended.

Functional description | Configurations 1/3

Linens holder

The bed can be equipped with a linen holder.



The linen holder should always be closed when not in use to prevent damage

The nurse keypad can be kept in the linen holder.

⚠ WARNING The linen holder must not be used as a seat or a step!
The safe working load of the linen holder is 20 kg.

Accessory rails on both sides

Three different lengths (20, 35 and 90 cm) of accessory rail are available for the bed.



Length	Length	Length
20 cm	35 cm	90 cm
Foot end	Centre	Head end

If the bed needs to be moved or adjusted, the infusion lines and cables must be closely monitored by care staff. You should also note that drainage devices could touch the floor when the bed is lowered. This also applies to the Trendelenburg and reverse Trendelenburg position.

The safe working load of the 35 cm and 90 cm long accessory rails is 20 kg in each case. For the 20 cm rail, the safe working load is 10 kg.

⚠ NOTE If the lying surface height is lowered to below 40 cm, any object attached to the accessory rail must be removed.

Castors

The following castors are available:



Integral S single castor 125 mm (135 kg/wheel)



Integral S single castor 150 mm (135 kg/wheel)



Linea twin castors 125 mm (150 kg/wheel)

The safe working load of the bed for all castors remains as specified on the type label.

Functional description | Configurations 2/3

Restraint holders

The bed can be equipped with a restraint holders. These can be attached to the frame and/or the lying surfaces.

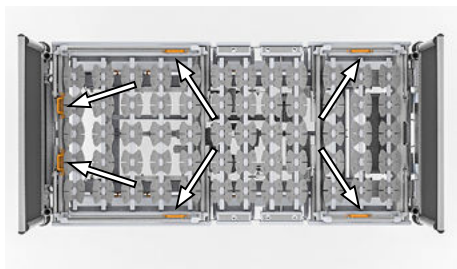

Attaching the restraint holders to the lying surfaces (only in conjunction with MiS® lying surface).

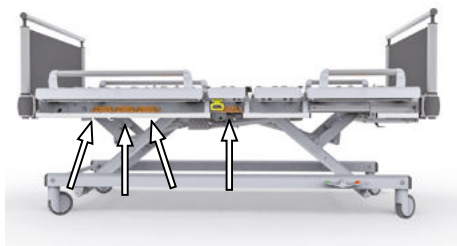

Restraint holder on the bed frame

Use of restraint systems

Restraint systems such as straps must only be used in accordance with the manufacturer's exact specification.



WARNING The adjustment functions of the lying surface must be locked when restraint is applied and the hand control must be kept out of the patient's reach.

Lying surfaces

MiS® lying surfaces

Völker MiS® is a positioning system in which different elements of the patient's spontaneous movement are maintained and encouraged.

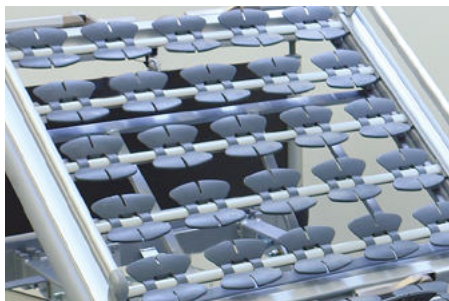

HPL lying surfaces

The 4-part HPL (high pressure laminate) lying surface is composed of moisture-resistant high-pressure laminate.



The lying surfaces are easy to remove and thus clean quickly and thoroughly.

Bed extension

The bed extension extends the bed lying surface by approx. 28 cm.

The bed extension is recommended for patients taller than 185 cm.



When using the bed extension, a mattress extender must be inserted.

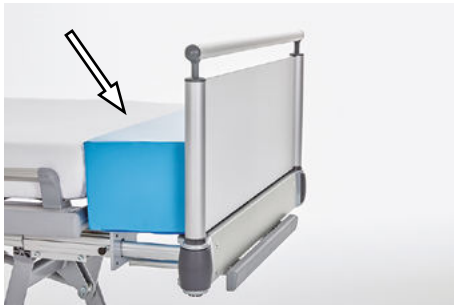

Brake alarm

If the bed is connected to the power supply and the brake is not depressed, an audible signal warning that the bed is not braked will be emitted.



The release button is affixed at the head end of the running carriage.

Spilt side rails

The bed can be equipped with the following split side rails:

- Height 34 - 35.5 cm*
- Height 37 - 38.5 cm*
- Height 43.5 - 45 cm*

* Measurement from the top edge of the side rail to the lying surface (without mattress). The various heights depend on the lying surfaces (MiS® or HPL), see also pp. 77–79.

Angle indicator

The tilt angle of the back section can easily be viewed using the angle indicator.



Bringing into service

The **Bringing into service** section describes how to prepare the bed for use, including function checks.

CONTENTS

General operating instructions	29
Preparation	30
Electrical commissioning	31
Use of the battery	32
Use of the battery and taking the bed out of service	33
Function check	34

Bringing into service | General operating instructions

Duty cycle

The maximum continuous duty cycle of the electromotive bed functions is given on the bed (type label, p. 6).

2 min/18 min means that each electromotive adjustment may be operated for a maximum of 2 minutes, followed by a break of 18 minutes (overheat protection).

- 🔔 **NOTE** If the maximum duty cycle of 2 minutes is exceeded for several times or longer, the result may be failure of the electromechanical drive due to the safety cut-out being triggered. The motor must not be used to adjust the bed until it has cooled down sufficiently.

Battery

The battery in the bed has a charge capacity which theoretically allows the continuous operation of at least 2 adjustment cycles.

- 🔔 **NOTE** If the bed is turned off where it is located and the power connector is not plugged in, this will result in battery discharge by buffering the electronic components.

Deeply discharged batteries may be damaged, making premature replacement necessary.

To obtain a long battery life, it is essential to handle it properly.

To ensure electrical function at all times, the bed should ideally be permanently connected to the mains.

If the bed is stored for a prolonged period, the battery must be recharged every 6 months, assuming a storage temperature of approx. 25° C. Reduce the time intervals at higher storage temperatures.

Safety mechanism

The bed is fitted with an electric automatically-resetting safety mechanism which prevents drive overload. In the event of a very high level of overload, the bed switches off automatically.

Setup conditions

The bed is approved for operation in dry rooms only (see Technical data, p. 73). A power supply is essential in the setup room for operating the bed.

Please note that the mains socket for the bed must be freely accessible and not impeded by a piece of furniture, for example.

Bringing into service | Preparation

Wiring of the control box

Each time the bed is brought back into service, the correct motor wiring sequence must be checked at the control box.

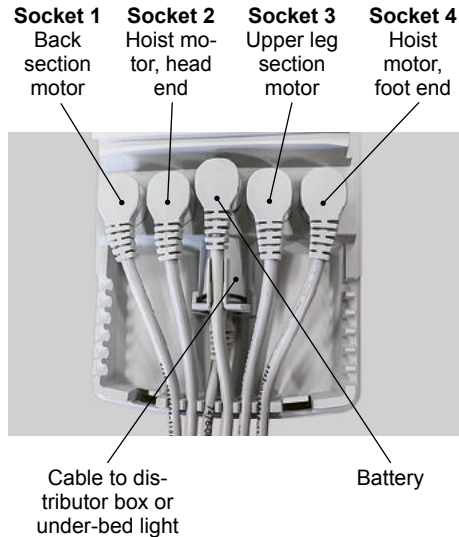

Distributor box wiring

The distributor box is attached to the fixed seat section on the left-hand side. In principle, the distributor box sockets can be occupied in any order. The factory configuration is shown below:

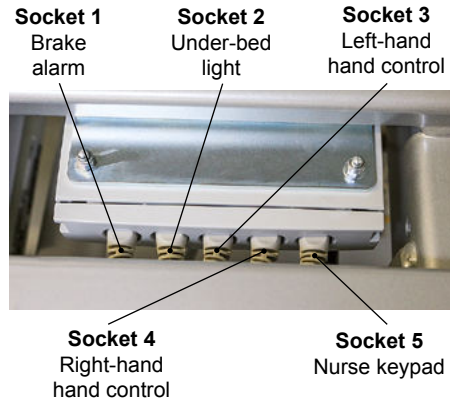

NOTE Please note that the plug connections on the control box and distributor box are splash-proof only when the lid is closed or the socket cover is in place!

Transportation

The bed can be moved without auxiliary transportation devices. To move the bed, switch it into driving mode (lying surface at a height of at least 40 cm and castors released).

To move the bed, the mains cable must be secured so that it cannot be crushed or damaged in any way. Use the cable hook supplied for this purpose. For operating the brakes/direction lock, see p. 59.



NOTE The bed should be moved by two people, one at the head end and one at the foot end.

Bringing into service | Electrical commissioning

To bring the bed into service, plug the mains plug into a socket.
The mains cable is strain-relieved.



Mains cable with cable hook

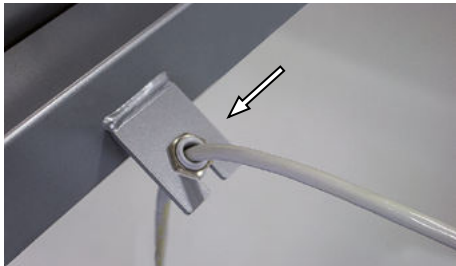

Strain relief on the mains cable at the head panel.

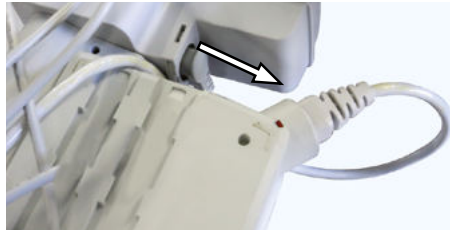

Connection of the power cable to the control box.



To avoid crushing and damaging the mains cable, it must not be positioned laterally at the head end, e.g. in order to reach another socket further away.

⚠ WARNING Regularly check the mains cable for damage. If the cable is damaged, the bed must not be used and must be taken out of service immediately.

The potential equalisation terminal is located on the underside of the head panel.

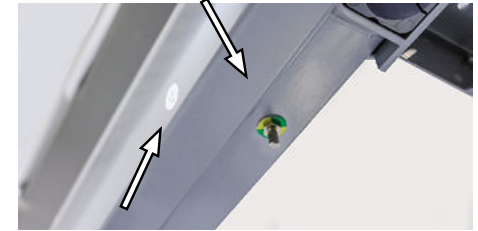

The terminal is marked with a label.

⚠ WARNING If electromagnetic interference with other devices occurs in the bed environment, please do not use these devices.

Bringing into service | Use of the battery 1/2

When fully charged, the battery enables the bed to be operated independently of mains power for at least two adjustment cycles.

If the bed is connected to the mains, the battery will automatically begin to charge.

When the bed is brought into service for the first time, it must be connected to the mains for approximately 24 hours to charge the battery fully.

If the bed is stored for a prolonged period, the battery must be charged at regular intervals (every 6 months). The maximum charging time is approximately 12 hours.

When the battery needs to be recharged, an audible signal will sound. The battery will shut down shortly before deep discharge. After the bed has been connected to the mains, press any button on the hand control to make it fully functional again. The battery will charge when the bed is connected to the mains after each use, or if the charge has dropped too far.

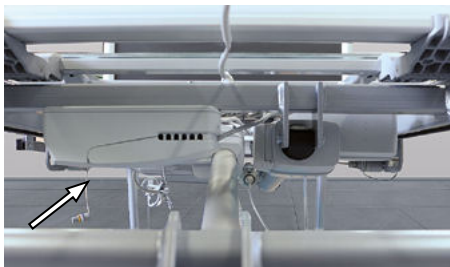

The battery is attached to the underside of the fixed seat.

NOTE If the bed is not connected to the mains for a long time, the battery will discharge. The extent of the discharge depends on the use of the adjustment functions and on environmental conditions.

Battery service life

The battery must be replaced after four years at the latest, or sooner if necessary depending on the intensity of use. Frequent and rapid discharging will reduce the service life of the battery. To achieve optimum service life, the battery should be connected to the mains as often as possible.

The battery must be charged at least every three months to avoid damage due to self-discharge.

Bringing into service | Use of the battery 2/2 - taking the bed out of service

NOTE The bed is specified for an ambient temperature of 5 °C to 40 °C, a relative humidity of 20 % to 90 % and air pressure of 800 to 1060 hPa.

WARNING The battery may be replaced only by staff trained by Völker GmbH.

WARNING A faulty battery may cause gas to evolve. In rare cases, this may cause the battery casing to deform. If this occurs, the bed must be taken out of service immediately and put into a well-ventilated area without sparks (electrical or fire). In such cases please inform Customer Service without delay!

NOTE The battery must be disposed of in the appropriate facilities in an environmentally-friendly manner. You are welcome to return it to Völker GmbH.

Taking out of service

Before any repair work is undertaken, the bed must be disconnected from the mains. If the bed is taken out of service for an extended period, the battery must be disconnected from the control box. To do this, use a suitable tool (e.g. a slot screwdriver) to open the control box and take the relevant (centre) plug out of the socket.

NOTE Please note that improper handling may result in the battery failing to charge. Improper handling includes, among other things, removing the plug from the socket by pulling on the mains cable, trapping the mains cable between the lying surface and the lying surface frame or running over the cable when moving the bed.



Bringing into service | Function check

Visual inspection

Every time the bed is newly occupied, check the items which follow.

1. The bed is undamaged externally.
2. The electric cable insulation is ok.
3. The motor cables are connected in number order to the corresponding sockets in the control box.
4. The next inspection date has not been missed (see inspection label, p. 6).
5. The mains cable must be checked for damage at regular intervals.

Function test

Every time the bed is newly occupied, a function test must be carried out.

1. All electrical functions must be operated to their end positions once.
2. The functioning of all side rails must be checked.
3. Bed locking must be checked.

If the function checks do not find any faults, the bed is then ready for use.



WARNING Only undamaged beds still within their test interval may be used.

The **Operation** section supplies all information on operating the bed.

CONTENTS

Side rails		Nurse keypad	
General safety instructions	36	Adjusting the upper leg section	50
Side rails	37	Nurse keypad	
Hand control Operating the hand control, nurse keypad	39	Adjusting the back section	51
Hand control		Nurse keypad	
Adjusting the back section	40	Adjusting lying surface height	52
Hand control		Nurse keypad Setting the Trendelenburg positions	53
Adjusting the upper leg section	41	Nurse keypad Setting and saving the comfort seating position and the egress aid	54
Hand control		Switching the under-bed light on/off, washing system position	55
Adjusting the lower leg section	42	Rapid lowering of the back section/ CPR function	56
Hand control		Bed extension	57
Adjusting the lying surface height	43	Castors	58
Hand control Setting the reverse Trendelenburg position	44		
Hand control			
Setting the Trendelenburg position	45		
Hand control Under-bed light	46		
Hand control			
Setting the comfort seating position	47		
Hand control			
Setting the bed egress aid	48		
Hand control Setting a horizontal lying surface position	49		

Operation | Side rails general safety instructions



WARNING All persons responsible for handling the side rails must read and follow this information.

- When adjusting the back, upper leg or lower leg sections or operating the hoist or the side rails, it is essential to ensure both that the patient does not come into contact with the side rails and that no body part is protruding through the side rails.
- If use of the side rails is necessary due to the patient's mental condition, it is important to ensure that the hand control is kept out of their reach or that all its functions are locked. The hand control units may also be taken off.
- Protective covers are available as an accessory for the side rails. These offer additional protection against injuries caused by contact with the side rails. Use of these protective covers is recommended for all persons with a very high risk of injury due to unavoidable contact with the side rails.

Using the covers does not mean that carers or patients should not take due care when operating the bed.

- All types of side rails must always be either completely raised and securely engaged, or completely lowered to the stop. Due to the pinch hazard, the side rails must **never** be left incompletely locked.
- If the side rails are damaged, the patient is in danger of falling out.



WARNING “Pinch hazard”

For patients whose physical or mental condition makes it necessary to use the side rails to prevent them from falling out of bed, observe the safety measures below.

- The legal admissibility of using the side rails must be ensured.
- The side rails may be operated by trained care staff only.
- Ensure that no body part is protruding through the side rails when actuating electrical lying surface adjustment.
- Ensure that the side rails (or parts thereof) are either fully raised and locked or fully lowered.



DANGER If the above safety measures are not observed by care staff, injury may ensue.

A. Raising the side rails

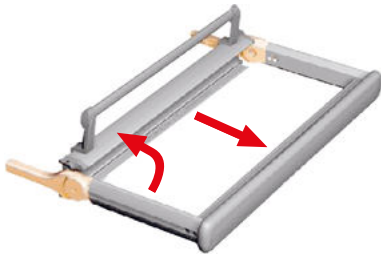

1. Pull the side rails out sideways and horizontally up to the stop, then raise them.



2. Pull the telescopic part up to the stop.

B. Lowering the side rails

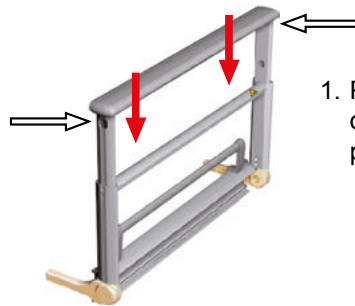

1. Press the two buttons on the outside of the frame to move the telescopic part into its lowest position.

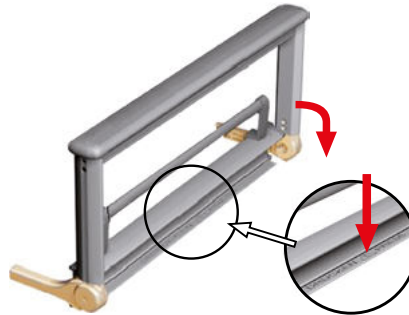

2. Operate the release button marked “Drücken / Press” on the bottom end of the side rails and tilt it sideways until it is horizontal and parallel to the floor.

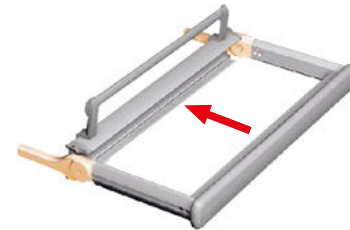

3. Push the side rail completely under the lying surface.

Operation | Side rails 2/2

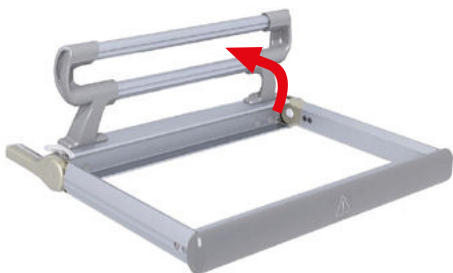

When using the higher side rails 43.5 - 45 cm, fold out the mattress holders before raising them/fold them in again after lowering them.

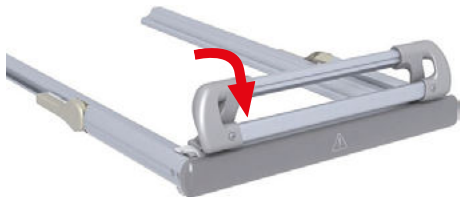

Ensure that the side rails measuring 43.5 - 45 cm are used only in combination with clamps at the head and foot ends. The head and foot ends must be precisely positioned so that the clamps are facing the inside of the bed. The warning label indicates the risk of crushing at this point.

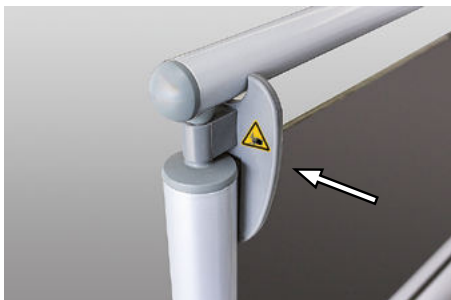

⚠ WARNING The side rails should always be held with both hands at the end of each element and then moved upwards or downwards.

💡 NOTE The stability of the side rails means that they can also be used for bedding storage (maximum 15 kg) or as a support surface for care-related bed positions, such as the Bobath position or when carrying out physiotherapy treatments.

Operation | Hand control, nurse keypad

Hand control

The hand control is connected to the bed by a plug-in connector. The connection sockets are located on both sides under the seat part.



Connection socket

Blind plugs

NOTE When not in use, the connection sockets must be sealed with the blind plugs.



The hand control units have a hook on the back which can be used to hang them on the side rails or the bed frame, for example.

Magnetic key



When the hand control lock is activated, this locks all the functions of the respective hand control.

If the bed functions cannot be operated, please check whether the hand control lock has been activated.

The magnetic key must only be used by care staff.



LED

To lock or unlock the hand control, move the magnetic key once over the release button. The LED will indicate that the unit is locked.

Nurse keypad

The nurse keypad can be found in the bedding storage drawer. Should the nurse keypad hang temporarily on the foot of the bed, it is important to ensure that the patient has no access to the nurse keypad.



The connection socket for the nurse keypad is located to the left under the foot of the bed.



Operation | Hand control | Adjusting the back section

The back section can be adjusted using the hand control.

The back section of the lying surface can be raised by an angle of up to 70°.

The back and upper leg sections can be adjusted at the same time by simultaneously pressing both switches:

- back section up + upper leg section up, or
- back section down + upper leg section down

If one of the two buttons is released during the adjustment process, the other sections of lying surface will continue to move.

It is not possible to operate the control “crossways” (e.g. back section up + upper leg section down).

WARNING When raising the back section with the side rails up, ensure that none of the patient’s body parts, nor the body parts of other persons, are protruding through the side rails or resting on them.



Back section up

WARNING “Pinch hazard”
When adjusting the back section, do not touch the frame in the back section area.

NOTE Allowing the patient to adjust certain bed functions using the hand control is the responsibility of care staff.

For reasons of safety, it is advisable to use the locking function if the patient is left unsupervised, or if the patient is confused or weak.

Operation | Hand control | Adjusting the upper leg section

The upper leg section can be adjusted using the hand control.

The upper leg section can be raised by an angle of up to 45°.

⚠ WARNING When raising the upper or lower leg section with the side rails up, ensure that none of the patient's body parts, nor the body parts of other persons, are protruding through the raised side rails or resting on them.

⚠ WARNING "Pinch hazard" There is a pinch hazard between the raised side rails and the foot end when the upper leg section is being adjusted.

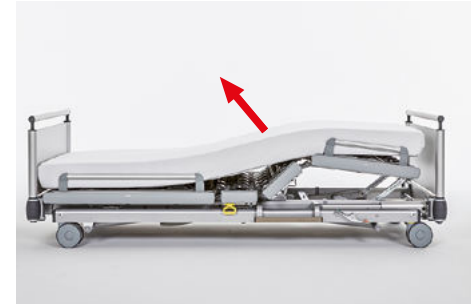
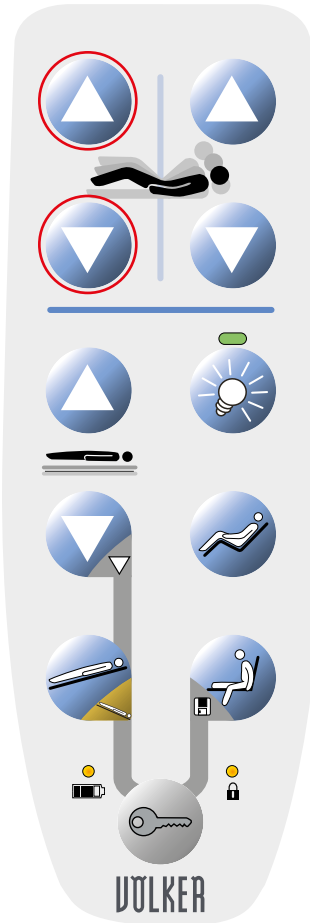

Upper leg section up

Operation | Adjusting the lower leg section (manually)

The lower leg section can be moved manually into any height position by pulling the mattress holder.

To lower the lower leg section, raise it by pulling the mattress holder up to the stop, then lower it. The Rastomats [latches] release automatically.

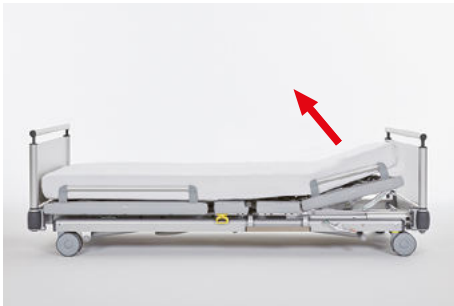

Lower leg section up

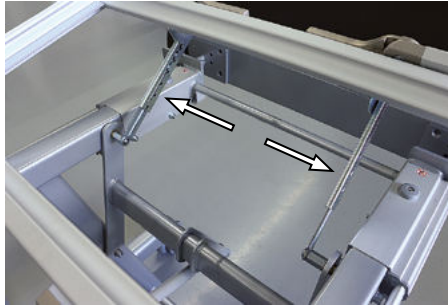

Rastomats [latches] for adjusting the height of the lower leg section.

Operation | Hand control | Adjusting lying surface height

Lying surface height can be adjusted using the hand control.

Lying surface height can be adjusted to between approx. 29 cm and approx. 89 cm (depending on choice of castors).

The lying surface can be adjusted downwards by the patient to a height of approx. 40 cm only.

To lower the lying surface to below 40 cm, use the following key sequence:

- briefly press the release button, then release it again
- then (within 2 seconds) press the “lying surface down” button until the desired position has been reached.

⚠ WARNING Only care staff may operate the release button.

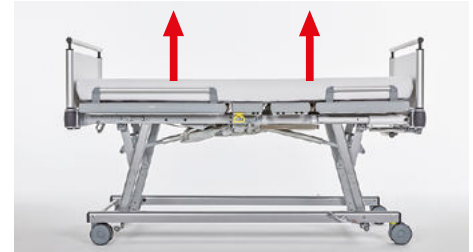
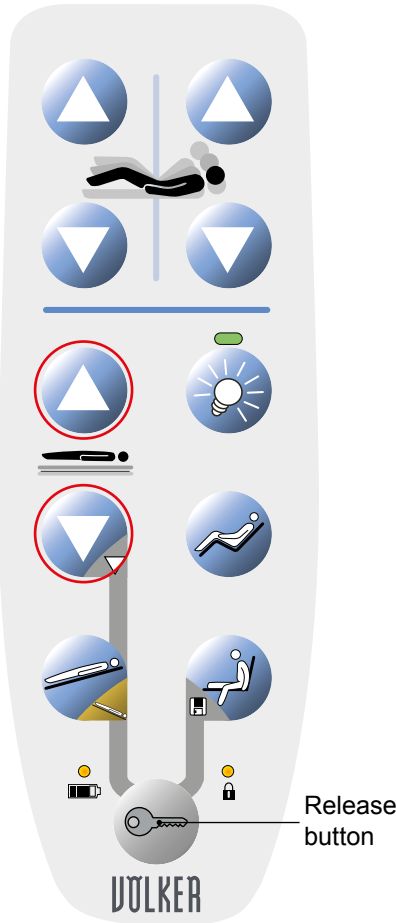

Lying surface up

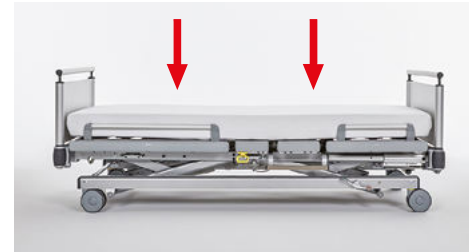

Lying surface down

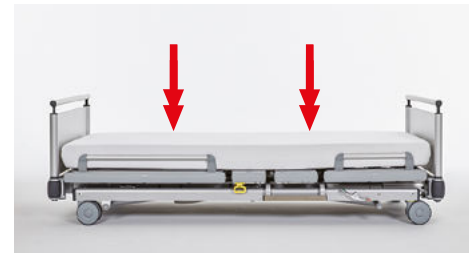

Lying surface low

Operation | Hand control | Setting the reverse Trendelenburg position¹

The reverse Trendelenburg position can be adjusted by an angle of up to 14°.

To set the reverse Trendelenburg position, the relevant key must be pressed until the desired position has been reached.

When using the reverse Trendelenburg position, it must be ensured that any drainage lines attached to the bed do not touch the floor.

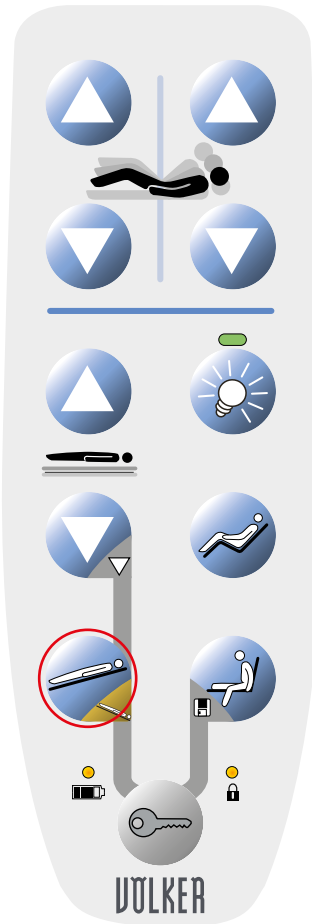

Reverse Trendelenburg position¹

¹ Head end raised

Operation | Hand control | Setting the Trendelenburg position¹

⚠ WARNING As the Trendelenburg position depends on clinical indications, it must be used on medical grounds only.

The Trendelenburg position can be adjusted by an angle of up to 14°.

To set the Trendelenburg position, the following key sequence must be observed:

- briefly press the release button, then release it again
- then (within 2 seconds), press the “Trendelenburg position” button until the desired position has been reached.

When using Trendelenburg positions, ensure that any drainage lines attached to the bed do not touch the floor.

⚠ WARNING Only care staff may operate the release button.



Trendelenburg position¹

¹ Head end lowered

Operation | Hand control | Under-bed light

The “under-bed light” button switches the light located under the bed on and off.

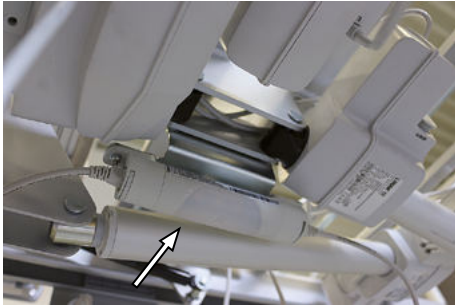

The under-bed light is mounted under the centre of the lying surface.

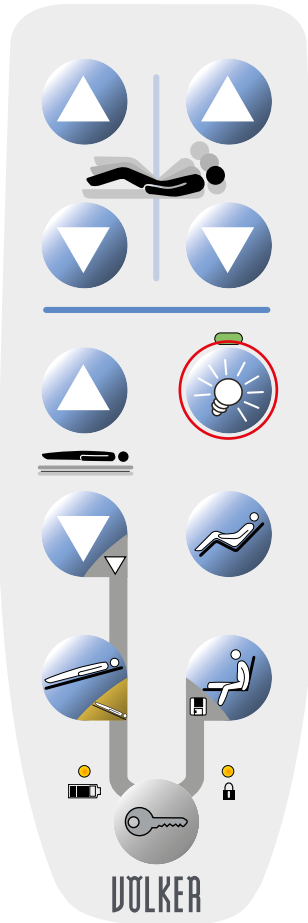

Operation | Hand control | Setting the "Easy Chair" position

The "Easy Chair" position allows the patient to assume an individual seating position.

To set the seating position, the relevant key must be pressed until the desired position has been reached.



"Easy Chair" position

Operation | Hand control | Setting the egress aid

The “Egress aid” function moves the bed into a position which allows the patient to leave the bed at the push of a button.

If no height position has been stored, the lying surface moves to a height of approx. 50 cm.

It is a good idea to store a height position, as this allows the patient to leave the bed safely and comfortably.

Individual egress position heights from a height of 40 cm can be stored.

 **WARNING** Please make sure that the castors are braked before the patient enters or leaves the bed.

 **WARNING** Only care staff may operate the release button.

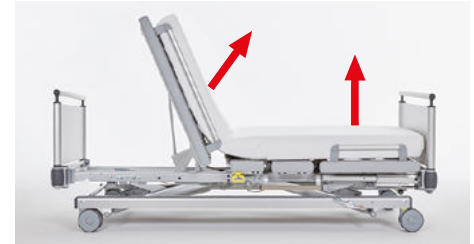
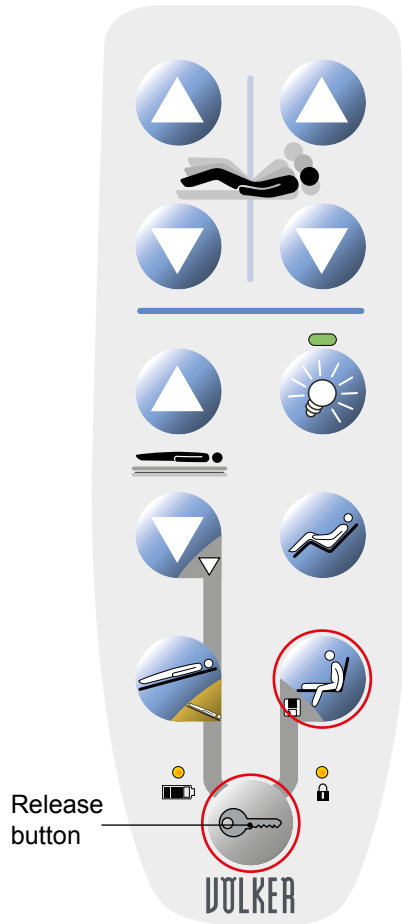

Bed egress aid

Storing an egress height

To store an egress height, the following key sequence is required:

- briefly press the release button, then release it again
- then (within 2 seconds) press the “Egress aid/Memory function” button, until a beep confirms the value is saved.

If the lying surface moves, it will stop briefly at the stored position (approx. 0.5 seconds) and will then continue moving while the “lying surface height adjustment” button remains depressed. The saved position is retained until a new position is saved.

Height range for memory: from 50 cm depending on the configuration chosen.

Operation | Hand control | Setting a horizontal lying surface position

The horizontal position of the lying surface can be achieved by simultaneously pressing the “upper leg section down” and “back section down” buttons.

If both buttons are pressed simultaneously, the lying surface will move into a horizontal position. Then the back and upper leg sections will be lowered.

If one of the two buttons is released during the adjustment process, the movement whose button is still depressed will continue.

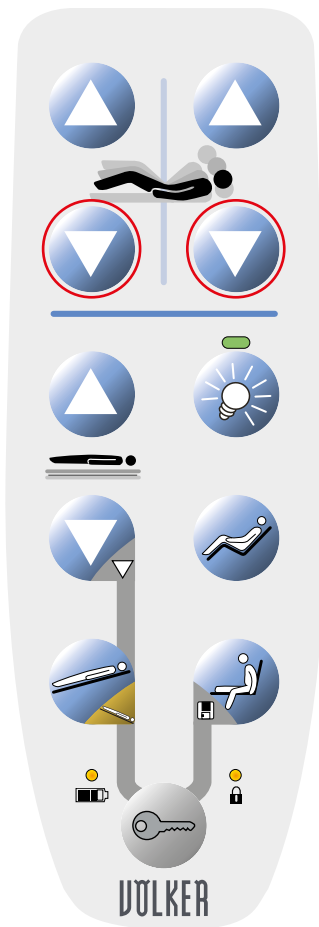

If the bed is completely obstructed, this button combination will restore the hand control's default settings.

To do this, press the “upper leg section down” and “back section down” buttons together for approx. 10 seconds, until you hear a beep confirming the reset.

Operation | Nurse keypad | Adjusting the upper leg section

The upper leg section can be adjusted using the nurse keypad.

The upper leg section can be raised by an angle of up to 45°.

These functions can be locked using the lock button, which also locks the hand control. Locking will be indicated by the LED which will remain lit. At the same time, the “Easy Chair” position function will also be locked.



Upper leg section
up/down
lock button

WARNING When raising the upper or lower leg section with the side rails up, ensure that none of the patient’s body parts, nor the body parts of other persons, are protruding through the raised side rails or resting on them.

WARNING “Pinch hazard”
There is a pinch hazard between the raised side rails and the foot end when the upper leg section is being adjusted.

WARNING Only care staff may operate the nurse keypad.

Operation | Nurse keypad | Adjusting the back section

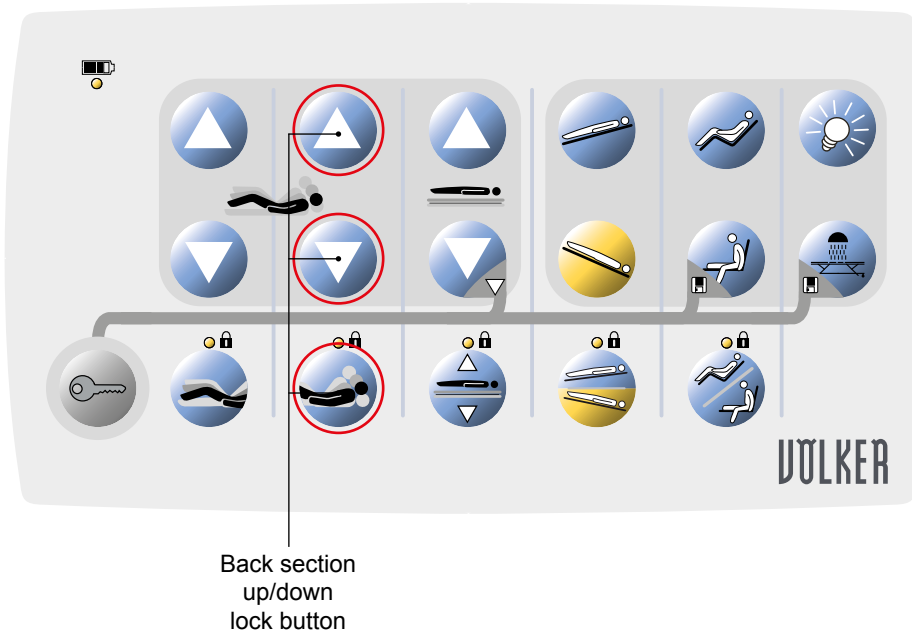

The back section can be adjusted using the nurse keypad.

The back section of the lying surface can be raised by an angle of up to 70°.

These functions can be locked using the lock button, which also locks the hand control. Locking will be indicated by the LED which will remain lit. At the same time, the “comfort seating position” and “egress aid” functions will also be locked.

Operation | Nurse keypad | Setting the Trendelenburg positions

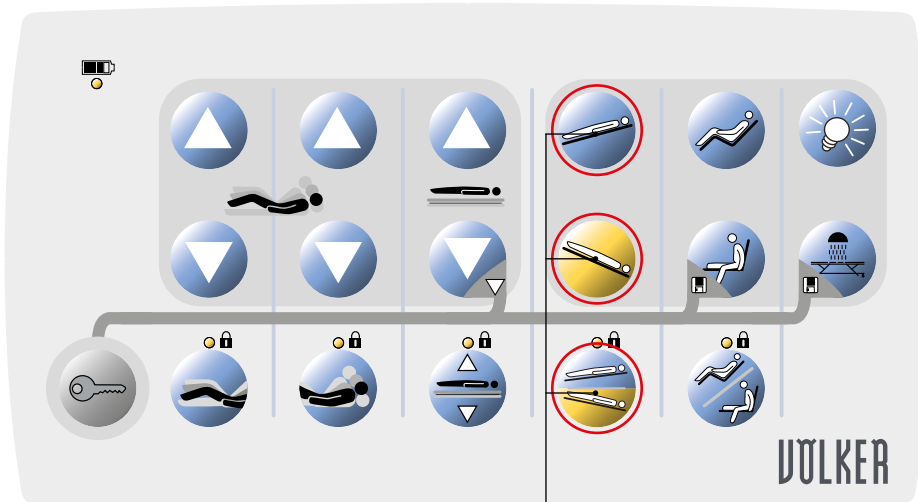

Reverse Trendelenburg,
Trendelenburg position
lock button

Both the reverse Trendelenburg and Trendelenburg positions can be set with the nurse keypad. The release button does not have to be activated.

These functions can be locked using the lock button, which also locks the connected hand control. Locking will be indicated by the LED which will remain lit.

⚠ WARNING As the Trendelenburg position depends on clinical indications, it must be used on medical grounds only.

Operation | Nurse keypad | Setting the “Easy Chair” position and the egress aid

The “Easy Chair” position and the egress aid can be set using the nurse keypad, with no need to use the release button.

To set the “Easy Chair” position, the relevant key must be pressed until the desired position has been reached.

The **Egress aid** function moves the bed into a position which allows the patient to leave the bed at the push of a button.

If no height position has been stored, the lying surface moves to a height of approx. 50 cm.

Individual egress position heights from a height of 40 cm can be stored.

To store a height position, the following key sequence is required:

- briefly press the release button, then release it again
- then (within 2 seconds) press the “Egress aid” button until a beep confirms the value is saved.

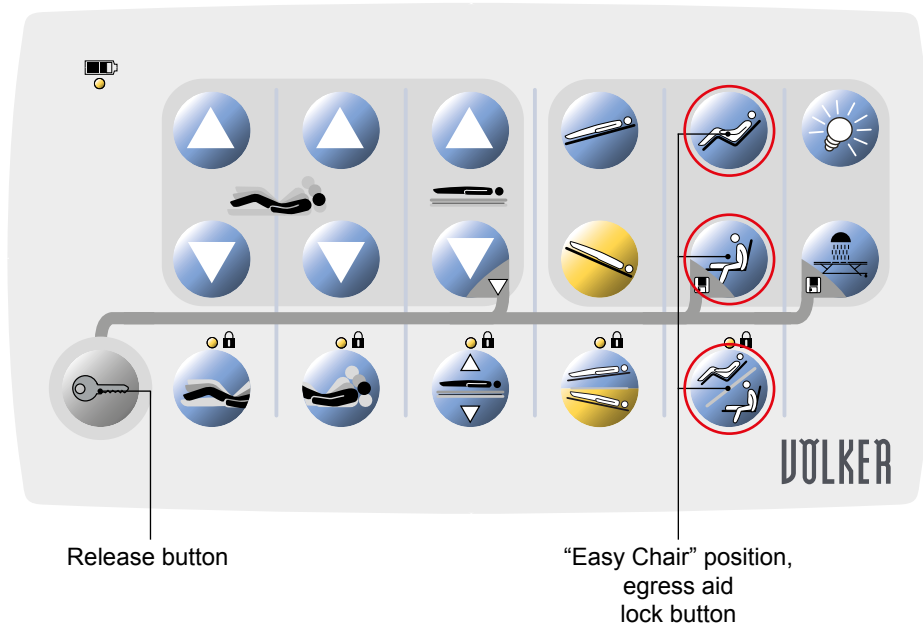

These functions can be locked using the lock button, which also locks the hand control. Locking will be indicated by the LED which will remain lit.

Operation | Nurse keypad | Under-bed light and washing system position

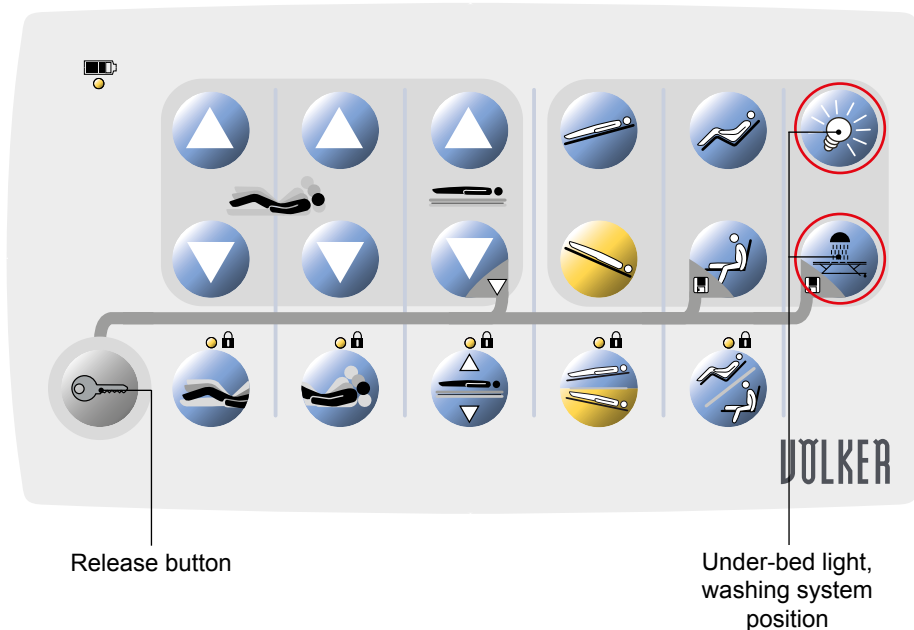

The **under-bed light** can be switched on and off with the nurse keypad.

When activating the **washing system position** button, a default position is adopted, but this position can be adapted individually to suit the system in question using the adjustment buttons.

To store a washing system position, the following key sequence is required:

- briefly press the release button, then release it again
- then (within 2 seconds) press the “washing system position” button until a beep confirms the value is saved.

NOTE Please refer to the information on the type label to ascertain whether your bed is suitable for the washing system.

Operation | Rapid lowering of the back section / CPR function

The bed is equipped as standard with a mechanical rapid lowering of the back section function for the purposes of resuscitation (CPR).

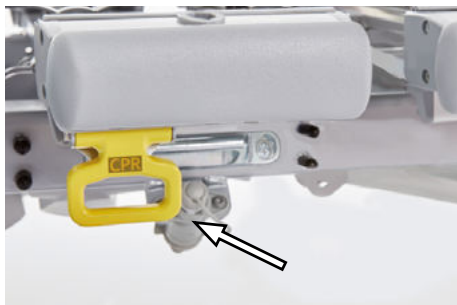

Handle on both sides for the rapid lowering of the back section for resuscitation.

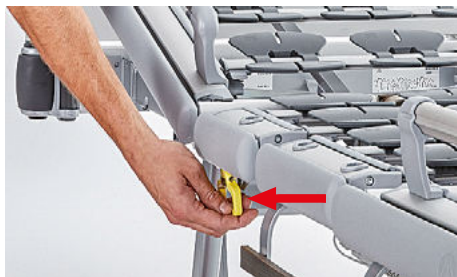

Pull the yellow handle forward to lower the back section rapidly.
The back section will lower rapidly.

The backrest motor will be activated automatically when the CPR handle is released.

Improper use of the CPR function may result in damage to the bed and/or the back section motor.

⚠ WARNING The CPR function (cardiopulmonary resuscitation function) must be used in **emergencies** and by trained, qualified staff only.

⚠ WARNING The CPR function must **not** be used instead of the hand control to lower the back section.

The bed can be equipped with a bed extension; the extension is approx. 28 cm.

The bed extension is attached to the frame at the foot end beneath the lying surface.

To unlock the bed extension, pull the two pins located on the side outwards and turn the heads by approx. 45°. The bed extension can now be pulled out.

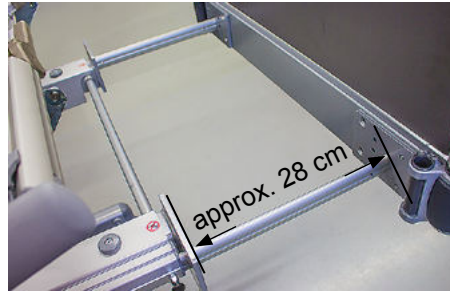

Bed extension extended



For locking, turn the heads back again until the pins automatically and audibly snap back into place.

The bed extension must also be engaged when retracted.



When using the bed extension, a suitable mattress extension wedge must be used.



WARNING The bed extension must not be used as a seat!
The safe working load is 50 kg.

Operation | Castors

Securing the brakes

When the brake lever with the orange rubber pedal is depressed, all the bed castors are braked.

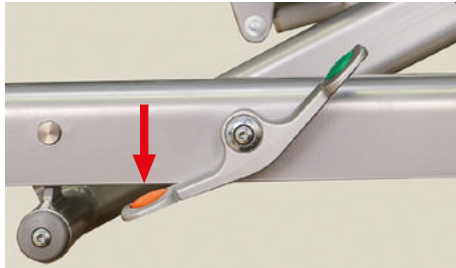

Locking the direction locker

Press down the green rubber pedal to lock the direction locker. This facilitates moving in a straight line when transporting the bed.



Releasing the brakes

To override the locking of all castors, move the brake lever into the horizontal position. The bed can be moved freely and rotated on the spot.



Cleaning and disinfection

This section contains information on **cleaning and disinfecting** the bed.

CONTENTS

Cleaning	60
Disinfection by wiping	60
Spray lances and washing systems	61
Cleaning the hand controls/ keypads	61

Cleaning and disinfection 1/2

To maintain the bed's functionality, it should be cleaned, disinfected and tested

- at regular intervals
- as required
- after every change of patient
- in accordance with the guidelines of the respective hygiene schedule

so that it can be used again immediately and without risk. Hazards may arise due to improper cleaning/disinfection of the bed.

As a general rule, only state-of-the-art disinfectants should be used.

The current healthcare standard can be found, for example, in the VAH List [from the German Association of Applied Hygiene], RKI [Robert Koch Institute] guidelines or also in the IHO List [from the German Industrial Association for Hygiene and Surface Protection]. Unless any specific ingredients which may NOT be used are given in the respective instructions for use, the disinfectants listed there may be used.

The disinfectants themselves should be used in accordance with the disinfectant manufacturer's instructions.

Therefore it is worth checking in-house hygiene protocols.

Due to the large number of available products, Völker GmbH cannot approve specific products and list them in the instructions for use.

Please observe the information provided by the cleaning product manufacturer.

Not following these instructions may lead to personal injury and material damage.

 **WARNING**
“**Danger of electric shock/fire and loss of function**” The bed must always be disconnected from the power supply before being cleaned and disinfected.

Cleaning

Depending on the degree of soiling, we recommend cleaning the bed with a damp cloth or similar. For stubborn dirt or stains, a soft brush may also be used. Do not moisten the bed too much when cleaning.

Disinfection by wiping

The dilution ratio recommended in the relevant instructions for use by the

cleaning product manufacturers must be used.

 **NOTE** Solvents are not permitted.

- Abrasives, scouring pads or other scouring agents must **not** be used.
- Chlorine, formaldehyde, phenol-based products and other solvents (toluene, xylene or acetone) are **not** allowed.

The following information regarding cleaning products and disinfectants must be observed:

- the solutions for use must as a rule be freshly prepared.
- the concentrations quoted should be neither exceeded nor undershot. the so-called “shot” method must not be used under any circumstances. Under no circumstances may users add cleaning products such as soap or surfactants at their own discretion (protein-related faults).
- with spray disinfectants containing alcohol, there is the danger of explosion and fire when used over a large surface.

- cleaning products must not contain corrosive or caustic ingredients.
- they must not contain any substances that will change the surface structure or the gripping properties of materials.
- lubricants must not be affected.
- the pH of the water must not be higher or lower than 6-8.
- the water must not exceed a total water hardness of 0.9 mmol/l (corresponding to 5 °dH).

The information provided by us does not exempt users from conducting their own investigations and tests, since the conditions (e.g. water hardness) can be different locally. No legally binding assurance of certain properties can be deduced from this information.

Cable plugs and the sockets of the control box, distributor box and battery are protected against splashes only when connected and when protected by the covers and blind plugs provided.

- Avoid the ingress of water and cleaning agents into unused connections.
- Labels and markings must not be cleaned with a brush or with high pressure.

- Dry the bed with special care and test it before re-use.
- Stubborn dirt or stains should be soaked before cleaning (please test first).

Spray lances and washing systems*



WARNING

Cleaning and disinfection with the spray lances of high-pressure cleaning equipment is **not** permitted.

Völker GmbH does not accept liability for damage sustained to the surface coating through the use of unsuitable detergents and disinfectants, incorrect mixing ratios or insufficient care of the beds.

Cleaning the hand control units/ keypads

To avoid cross-contamination between the patient and care staff, the hand control units and keypads must be cleaned daily.

*Please refer to the information on the type label to ascertain whether your bed is suitable for the washing system.

Maintenance

The **Maintenance** section contains information on conducting maintenance work.

CONTENTS

Staff qualifications, safety instructions	63
Maintenance schedule	64

Maintenance | Staff qualifications, safety instructions

Staff qualifications

Any person responsible for maintenance and service provision must at least have read the safety regulations for the relevant bed model and be qualified in accordance with the relevant national regulations.

To guarantee smooth operation of the beds, the instructions for use for the bed must always be accessible to service staff.

Safety instructions

The following requirements must be strictly complied with during maintenance and technical checks:

- the electrical installation of the room must meet the requirements of the current state of the art, and the bed must be used as intended.
- the beds are not explosion-protected and may only be serviced in an environment free from combustible materials.



WARNING Always unplug from the mains before conducting repair work.



WARNING Maintenance and repair work may only be conducted after the bed has been disinfected.

Maintenance | Maintenance schedule

The bed requires very little maintenance. All moving parts of the height adjuster, lying surface drives and side rails are provided with permanent lubrication at the factory.

It is recommended that **the bed undergo a technical check regularly, at least once per year, according to the checklist** (p. 84) and that any damage discovered, such as wear and tear, loose screws or breaks be repaired at once.

Time period	Work to be carried out
Annually	Technical check (p. 84)
After prolonged periods out of use	Visual and functional inspection (p. 66)
As required	Lubrication of mechanical parts Replacement of battery when faulty and when the end of service life is reached (3 years) Replacement of wear parts when faulty, e.g. <ul style="list-style-type: none">• MiS[®]lying surface wings• MiS[®]lying surface spring elements

The **Technical check** section contains all the information required for conducting the technical check to satisfy the requirements of the German Medical Devices Operator Ordinance (MPBetreibV), German Statutory Accident Insurance regulation 3 (DGUV V3), German Accident Prevention Regulations (UVV) for hospital and care beds and measurement in accordance with DIN EN 62353. Other (e.g. country-specific) regulations are not included here. This does not absolve the operator from complying with these regulations.

CONTENTS

Visual inspection	66
Side rail function inspection	66
Brake function inspection	67
Drive function inspection	67
Mains cable	67
Wiring	67
Casing	67
Mechanical inspection	67
Checking the handle	67
Other accessories	67

Technical check 1/2

1. Visual inspection

Check the frame parts for plastic deformation and/or wear. This includes the undercarriage, hoist, all lying surface elements (back, seat, upper and lower leg sections, wings and spring elements), trapeze bar, trapeze bar holder and castors.

2. Side rails function inspection

The side rails must be inspected for catch and pinch points in accordance with DIN EN 60601-2-52.

Check that the side rail lock functions properly and whether any deformation or wear is visible on the side rails.

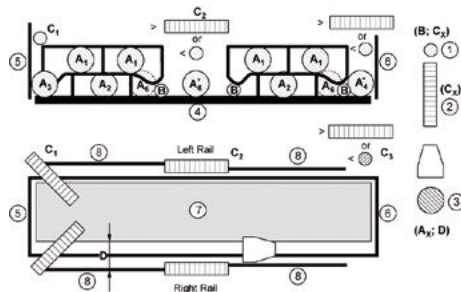

Letter	Description	Dimension
A _x	Distance between elements within the scope of the SIDE RAILS in a raised/engaged position or in the area formed by the SIDE RAILS and fixed parts of the BED or ACCESSORIES.	< 120 mm
B	Bottom edge of side rails to upper edge of lying surface	< 60 mm
C ₁	Distance between HEAD END and SIDE RAILS	< 60 mm
C _{2,3}	Distance between split SIDE RAILS and distance between SIDE RAILS and FOOT END	< 60 mm or > 318 mm
D	Area between SIDE RAILS and MATTRESS	120 mm cone must sink below the mattress surface by no more than 60 mm without pressure.
G	The height of the top edges of the SIDE RAILS above the mattress without compression over at least 1/2 of the length of the LYING SURFACE	≥ 220 mm

3. Brake function inspection

Check the functionality of the brake.

4. Drive function inspection

Run the complete adjustment range for each individual motor. Pay attention to unusual noises, speed, smooth running etc., and that the selected function moves in the right direction. In particular, ensure that the motor shuts down independently when it reaches the end position.

5. Mains cable

Check the following for damage:

- the mains cable, including cable ducts
- strain relief, including the anti-kink sleeve
- the mains connector.

6. Wiring

Check cable routing and that the plug contacts are located properly; look for damage. Check cables for damage.

7. Casing

Check all casings for damage. All screws must be tight and seals must have no visible signs of damage.

8. Mechanical inspection

Check Rastomat [latch] functionality by moving the lower leg section manually into the individual positions. The rapid lowering of the back section for CPR must also be checked for functionality in this way.

9. Handle

Check whether the plastic and strap-hangers of the trapeze bar handle show any damage, and whether the fixing rods on the trapeze bar are in good condition. The handle and fastening strap must be replaced in the following cycles:

- every 3 years in hospital operation
- every 2 years when cleaned with industrial bed-washing systems
- every 5 years in care services

10. Other accessories

Other accessories must always be checked in accordance with the manufacturer's instructions.

Troubleshooting

The **Troubleshooting** section contains a table of faults for users, as well as information on service centres.

CONTENTS

Table of faults

69

The following table contains information about possible malfunctions which can be resolved by the user.

Any person responsible for maintenance and service provision must at least have read the safety regulations for the relevant bed model and be qualified in accordance with the relevant national regulations.

To guarantee smooth operation of the beds, the instructions for use for the bed must always be accessible to service staff.

 **NOTE** Before any troubleshooting, check that the bed is connected to the mains (mains plug in a live socket).

 **WARNING** Ensure that the bed is disconnected from the mains before starting repair work.

Troubleshooting | Table of faults 2/2

Fault	Possible cause	Remedy
Bed adjustment does not work	<p>Hand control locked</p> <p>Mains plug not connected or socket has no power</p> <p>Battery not functioning</p> <p>Hand control not functioning</p> <p>Mains plug not connected or socket has no power</p> <p>Battery not functioning</p> <p>2-minute adjustment cycle exceeded</p>	<p>Unlock the hand control</p> <p>Connect plug or check socket</p> <p>Check/replace battery</p> <p>Check/replace mains cable</p> <p>Unlock hand control (p. 39) or connect plug or replace hand control</p> <p>Unlock hand control (p. 39) or connect plug or replace hand control</p> <p>Connect plug or check socket</p> <p>Check/replace battery</p> <p>Check/replace mains cable</p> <p>Wait for cooling cycle (18 minutes)</p>
Back section adjustment does not work	CPR lever obstructed	Check CPR lever for obstruction and repair or replace if required
Mechanically adjustable lower leg section adjustment does not work	Faulty Rastomat [latch]	Replace Rastomat [latch]
Under-bed light (depending on configuration) not functioning	Hand control not connected or bulb faulty	Connect hand control or replace bulb

The **Appendix** section contains the technical specifications and classifications, information on service life and disposal, as well as links to the manufacturer's declarations and forms in the appendix.

CONTENTS

Symbols used	72
Technical data	73
Classification	74
Service life / disposal	75
S 964 dimension sheet	76
Side rail dimension sheets	77
Guidelines and manufacturer's declaration - electromagnetic immunity	80
Forms	84
Electronic instructions for use	86

Appendix | Symbols used



Warning sign

Information marked with this symbol must be read and strictly observed.



NOTE warns of possible material damage.



The product meets the essential requirements of Annex I of EU Directive 93/42 EEC.



Note the information in the instructions for use!



Manufacturer



Model name



Serial number

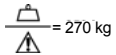

= 270 kg Safe working load 270 kg

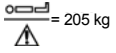

= 205 kg Maximum permitted patient weight 205 kg

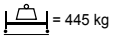

= 445 kg Mass of the mobile medical device inc. safe working load 445 kg



Protection class II equipment, double insulated



Type B applied part in accordance with DIN EN 60601-1



The device must be disposed of in accordance with EU Directive 2002/96/EC on waste electrical and electronic equipment.



Classification for floors



Potential equalisation terminal

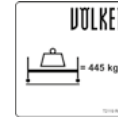

Mass of the mobile medical device inc. safe working load

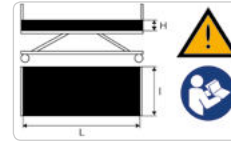

Please read the information and follow the instructions for use for the mattresses!

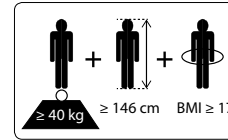

Description of an adult



TÜV SÜD-certified [Technischer Überwachungsverein SÜD - German Technical Monitoring Association (South)]

The symbols shown below can be found as labels on the bed depending on configuration:



Risk of crushing



Do not sit here!

Dimensions and weights



Height of the lying surfaces	Integral S single castor 125 mm (135 kg/castor not washable) 32.3 - 87.3 cm Integral S single castor 150 mm (135 kg/castor not washable) 34.8 - 89.8 cm Linea twin castors 125 mm (150 kg/castor washable) 29.5 - 84.5 cm
External dimensions with lying surface 90 x 200 cm 100 x 200 cm	approx. 99 x 212 cm approx. 109 x 212 cm
Recommended mattress dimensions with lying surface 90 x 200 cm 100 x 200 cm	88 x 200 x 12 cm* 98 x 200 x 12 cm*
Bed weight	approx. 175 kg
Track width	81 cm
Track length	178 cm

* We recommend the use of Völker mattresses. If other mattresses are used, please observe the notes on p. 21.

Electrical data

Voltage	100–240 VAC
Power consumption	390 W
Nominal frequency	50 Hz / 60 Hz
Primary fuse	4.0 A time-lag
Duty cycle	2/18 min 10 % Duty Cycle Guard 2000 Ws (software)
Overload protection	Open bus output, poly switch 0.2 A
Overcurrent cut-out	Maximum 10A per drive (hardware)
Operating temperature	+ 5 °C to + 40 °C
Storage temperature	- 10 °C to + 50 °C
Humidity	20 % to 90 % at 30 °C - no condensation
Air pressure	700 hPa to 1060 hPa
Operating altitude	Maximum 2000 m above MSL

Appendix | Classification

Protection against electric shock	Protection class II or device with internal electrical power source 
Degree of protection in accordance with EN 60529	Electronics IPX6 Whole hospital bed IPX4
Degree of protection of the application part against electric shock in accordance with DIN EN 60601-1	Type B 
Degree of protection against explosive substances and mixtures	The bed is not explosion-protected and must not be used in an environment where flammable anaesthetics or flammable cleaning agents are present.
Grouping/classification in accordance with 93/42/EEC Annex IX	Class I
Technical check	1x annually (recommended)

Service life

The bed's expected service life is approx. 10 years.

Disposal information

- For all components to be disposed of, the operator must ensure that these are not infectious/contaminated.
- If the bed is scrapped, the wood, plastic and metal parts used must be separated and disposed of properly.
- If you have any questions, contact your local authorities, waste disposal companies or our service department.

Disposal of electrical parts

- This bed is electrically adjustable and classified as a commercial (b2b) electrical device in accordance with WEEE Directive 2012/19/EU (implemented in Germany in the Electrical and Electronic Equipment Act).
- The electrical components used are free of prohibited harmful constituents pursuant to the Restriction of Hazardous Substances II Directive 2011/65/EU.

- Replaced electrical components (drives, control units, hand control units, etc.) from these beds are to be treated and disposed of as electrical scrap in accordance with the WEEE Directive.
- The bed operator is legally obliged not to dispose of its electrical components in municipal collection points, but to send them directly to the manufacturer. Völker GmbH and its service partners will accept the return of these parts. Please contact our sales team in this regard.
- Our general terms and conditions apply to these returns.

Disposal of batteries

- Any individual batteries which have been removed but are no longer usable must be professionally disposed of in accordance with Directive 2006/66/EC (implemented in Germany in the Batteries Act); they do not belong in household waste.
- Contact your local waste disposal companies or our service department.

In other countries outside Germany/the EU, observe the national regulations in force there.

Appendix | Dimension sheet

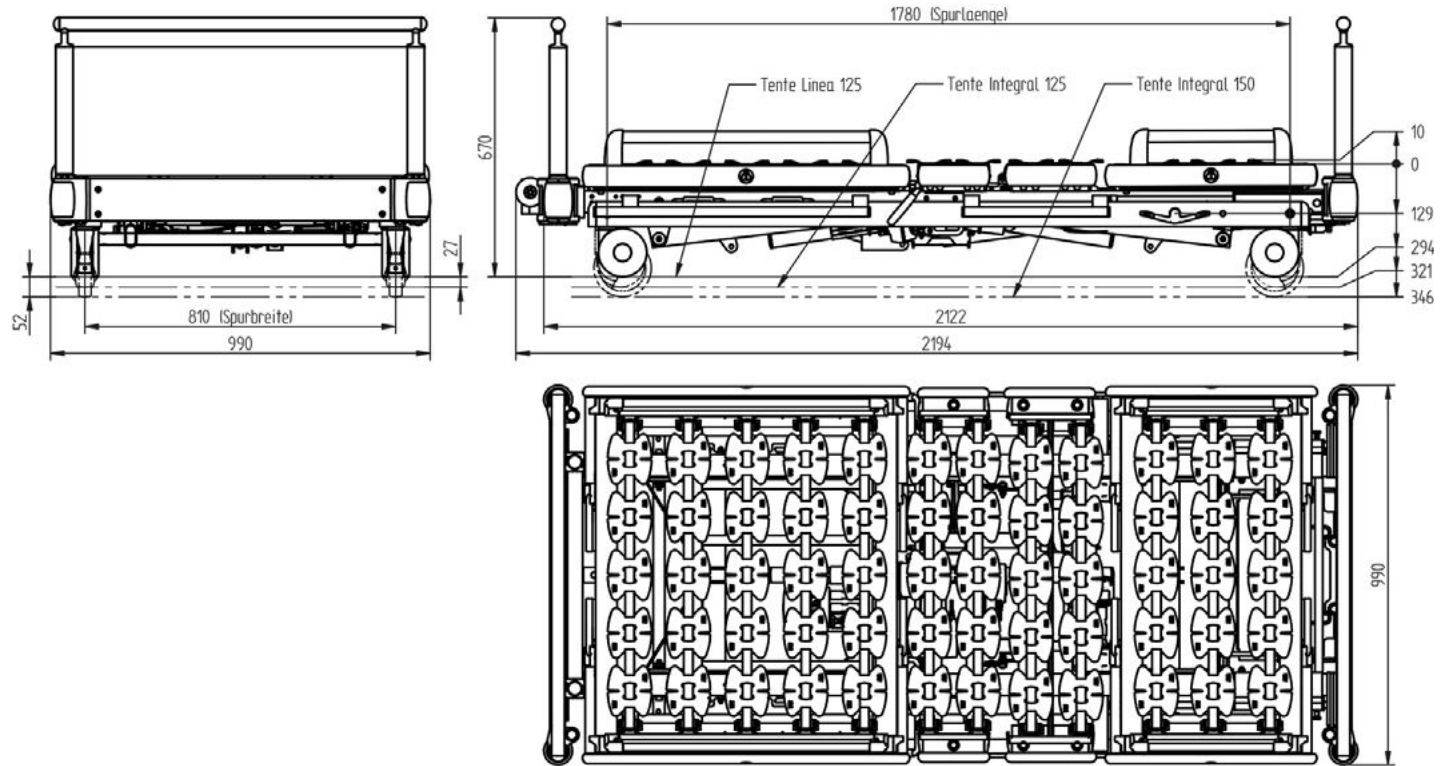

All dimensions in mm

Appendix| Side rails dimension sheet 1/3 – Height 34 - 35.5 cm

Split side rails 34 cm (back section) with MiS® lying surface

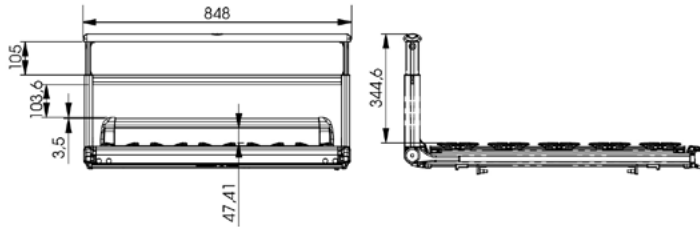

Split side rails 34 cm (upper leg section) with MiS® lying surface

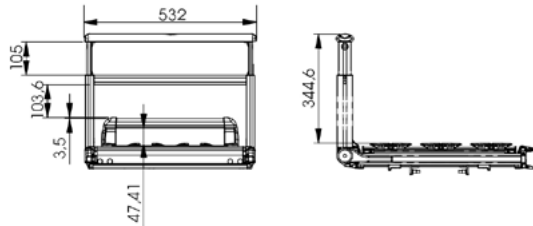

Split side rails 35.5 cm (back section) with HPL lying surface

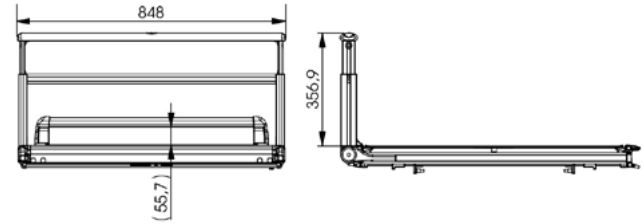

Split side rails 35.5 cm (upper leg section) with HPL lying surface

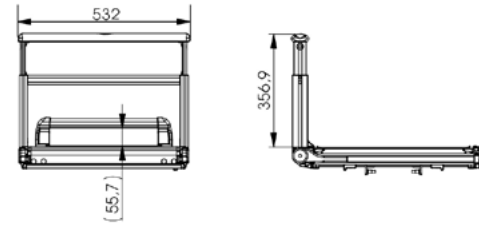

All dimensions in mm

Appendix| Side rails dimension sheet 2/3 – Height 37 - 38.5 cm

Split side rails 37 cm (back section) with MiS® lying surface

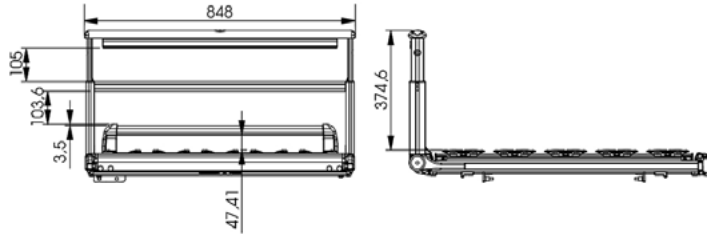

Split side rails 38.5 cm (back section) with HPL lying surface

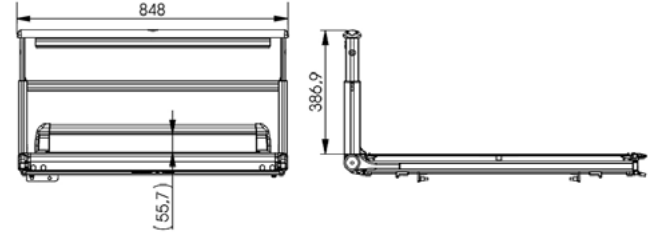

Split side rails 37 cm (upper leg section) with MiS® lying surface

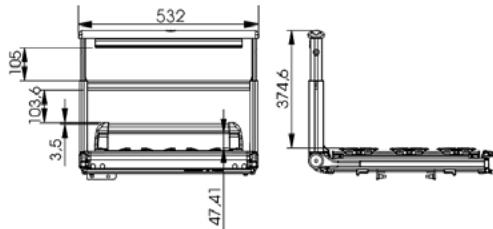

Split side rails 38.5 cm (upper leg section) with HPL lying surface

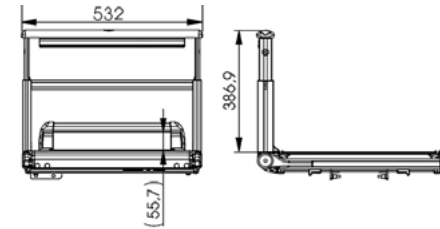

All dimensions in mm

Appendix| Side rails dimension sheet 3/3 – Height 43.5 - 45 cm

Split side rails 43.5 cm (back section) with MiS® lying surface

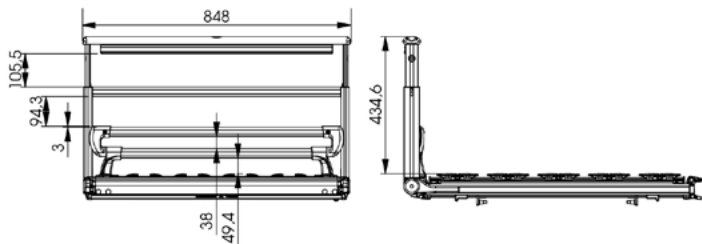

Split side rails 45 cm (back section) with HPL lying surface

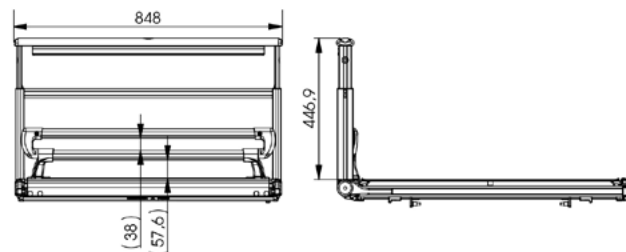

Split side rails 43.5 cm (upper leg section) with MiS® lying surface

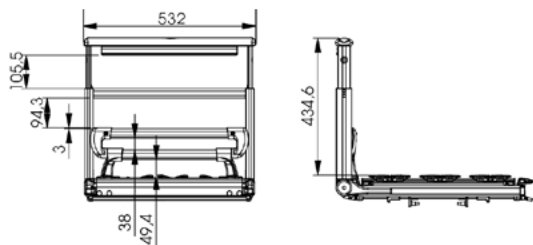

Split side rails 45 cm (upper leg section) with HPL lying surface

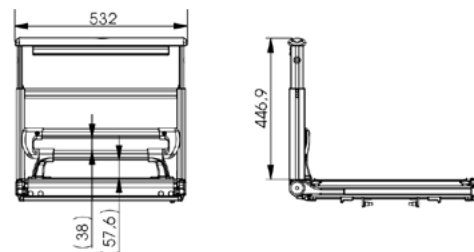

All dimensions in mm

Appendix | Manufacturer's declarations 1/4

Table 201 – Guidelines and manufacturer's declaration - electromagnetic immunity (6.8.3.201 a) 3))

The bed is intended for use in the electromagnetic environment specified below. The customer or the bed user should ensure that it is used in such an environment.

Emission measurements	Compliance	Electromagnetic environment – directive	
HF emissions DIN EN 61000-3-2	Class A	The bed is suitable for use in all facilities, including households and facilities directly connected to a public power grid that also supplies buildings.	
Voltage fluctuations/ flicker DIN EN 61000-3-3	Conforms		
RF emissions CISPR 14 – 1	Conforms	The bed is not suitable for connecting to other devices.	
Immunity test	IEC 60601 test level	Compliance level	Electromagnetic environment – directive
Electrostatic discharge (ESD) DIN EN 61000-4-2	Contact discharge ± 6 kV Air discharge ± 8 kV	Contact discharge ± 6 kV Air discharge ± 8 kV	Floors should be made of wood or concrete and covered with ceramic tiles. If the floor is covered with synthetic material, relative humidity must be at least 30%.
Electrical fast transients/ bursts DIN EN 61000-4-4	± 2 kV for power supply ± 1 kV for input and output cables	± 2 kV for power supply Not applicable	The quality of the supply voltage should be that of a typical commercial or hospital environment.
Surges DIN EN 61000-4-5	± 1 kV differential mode ± 2 kV common mode	± 1 kV differential mode Not applicable	The quality of the supply voltage should be that of a typical commercial or hospital environment.

Appendix | Manufacturer's declarations 2/4

Immunity test	IEC 60601 test level	Compliance level	Electromagnetic environment – directive
<p>Voltage dips, short interruptions and voltage fluctuations in the supply voltage</p> <p>DIN EN 61000-4-11</p>	<p>< 5 % U_T (> 95 % voltage peak in U_T) for 0.5 cycles</p> <p>40 % U_T (60 % dip in U_T) for 5 cycles</p> <p>70 % U_T (30 % dip in U_T) for 25 cycles</p> <p>< 5 % U_T (> 95 % dip in U_T) for 5 seconds</p>	<p>< 5 % U_T (> 95 % voltage peak in U_T) for 0.5 cycles</p> <p>40 % U_T (60 % dip in U_T) for 5 cycles</p> <p>70 % U_T (30 % dip in U_T) for 25 cycles</p> <p>< 5 % U_T (> 95 % dip in U_T) for 5 seconds</p>	<p>The quality of the supply voltage should be that of a typical commercial or hospital environment.</p> <p>If the bed user requires continued function even in the event of interruptions to the energy supply, it is recommended that the bed be supplied from an uninterruptible power supply or a battery.</p>
<p>Magnetic field at supply frequency (50/60 Hz)</p> <p>DIN EN 61000-4-8</p>	<p>3 A/m</p>	<p>3 A/m</p>	<p>Magnetic fields at mains frequency should correspond to the typical values found in the commercial and hospital environment.</p>
<p>Note 1: U_T is the AC mains voltage before application of the test level.</p>			

Appendix | Manufacturer's declarations 3/4

Table 204 – guidelines and manufacturer's declaration – electromagnetic immunity for all devices and systems which are not life-sustaining (6.8.3.201 b)

The bed is intended for use in the electromagnetic environment specified below. The customer or the bed user should ensure that it is used in such an environment.

Immunity test	IEC 60601 test level	Compliance level	Electromagnetic environment – directive
Conducted HF interference DIN EN 61000-4-6	3 Vrms 150 kHz to 80 MHz	3 V	
Radiated HF interference DIN EN 61000-4-3	3 V/m 80 MHz to 2.5 GHz	3 V/m	<p>Portable and mobile radio devices, including cables, should not be used in closer proximity to the bed than the recommended safety distance calculated in accordance with the equation applicable to the transmission frequency.</p> <p>Recommended safety distance</p> <p>$d = 1.17 \sqrt{P}$ 150 kHz to 80 MHz</p> <p>$d = 1.17 \sqrt{P}$ 80 MHz to 800 MHz</p> <p>$d = 2.33 \sqrt{P}$ 800 MHz to 2.5 GHz</p> <p>With P as the power rating in watts (W) of the transmitter as specified by the transmitter's manufacturer and d as recommended safety distance in metres (m).</p> <p>The field strength of fixed radio transmitters should be lower than the compliance level for all frequencies in accordance with an evaluation on site^{a, b}</p> <p>Interference is possible in the vicinity of devices bearing the adjacent icon.</p> 

Note 1: The higher frequency range applies at 80 MHz and 800 MHz.

Note 2: These guidelines may not be applicable in all cases. The propagation of electromagnetic variables is affected by the absorbent and reflective properties of buildings, objects and people.

^a The field strength of fixed transmitters, such as base stations for mobile phones and mobile radios, amateur radio stations, AM and FM radio and TV broadcasters cannot in theory be predicted with any accuracy. To determine the electromagnetic environment with regard to the location of the fixed transmitter, a study of the site should be considered. If the field strength measured in the location in which the bed is used exceeds the above compliance level, the bed should be monitored in order to verify intended function. If abnormal performance characteristics are observed, additional measures, such as reorientation or relocation of the bed, may be required.

^b Over the frequency range from 150 kHz to 80 MHz, the field strength should be less than 3 V/m.

Appendix | Manufacturer's declarations 4/4

Table 206 – Recommended safety distance between portable and mobile HF telecommunications equipment and the bed – for equipment and systems that are not life-sustaining (6.8.3.201 b))

The bed is intended for use in an electromagnetic environment in which HF interference is controlled. The customer or bed user can help to avoid electromagnetic interference by maintaining the minimum distance between portable and mobile HF telecommunications equipment (transmitters) and the bed. The recommended minimum safety distance d is dependent on the maximum output power of the communications equipment (see below).

Transmitter power rating W	Safety distance in accordance with transmitter frequency m		
	150 kHz to 80 MHz $d = 1.17\sqrt{P}$	80 MHz to 800 MHz $d = 1.17\sqrt{P}$	800 MHz to 2.5 GHz $d = 2.33\sqrt{P}$
0.01	0.12	0.12	0.23
0.1	0.37	0.37	0.74
1	1.17	1.17	2.33
10	3.69	3.69	7.38
100	11.67	11.67	23.33

For transmitters with a maximum power rating not specified in the above table, the recommended safety distance d in metres (m) can be determined using the equation for the respective column, where P is the maximum transmitter power rating in watts (W) as stated by the manufacturer.

Note 1: The higher frequency range applies at 80 MHz and 800 MHz.

Note 2: These guidelines may not be applicable in all cases. The propagation of electromagnetic variables is affected by the absorbent and reflective properties of buildings, objects and people.

Project, address, customer no.:	Name of technician:					
Type of bed, product, location of the bed	Component to be checked	Usually	Accepted	Not accepted	Not applicable	
Bed identification (e.g. facilities own identification or Völker ID-no.)	Inscription on device readable Instructions for use available					
Date of check:	Base frame	B*				
Kind of check	Visual inspection	Lying surface, wing and spring elements (if existing)	B*			
	Functional inspection of side rails including telescopic section, if applicable	Trapeze bar adapter, infusion bar adapter	B*			
		Power supply cable, plug or charger, charging connection	B*			
		Strain relieve, bend protection, cable hook	B*/S*			
		Connecting cable, plug-in contacts, blind plugs	B*/S*			
		Positioning (topping 1 mm) and sensor cabling (only Vis-a-Vis-bed)	B*/S*			
		Housing (motor, control electronics)	B*			
		Hand control (housing, cable)	B*			
		Nurse keypad, nurse hand control (housing, cable)	B*			
		Trapeze bar, asset rail (side panel) (side rail centre), additional accessories	B*/F*			
		Transverse motors and cover, head and foot ends	B*			
		Castors	B*			
		Wall buffer wheel (if existing)	B*			
		Side rails including telescopic section, if applicable	B*			
		HiLo-elevation: check screw locking (only for S380)	S*			
Locking devices	X*					
Deformation	X*					
Abrazions	X*					
Functional inspection of drives with nurse keypad/nurse hand control	Back section, upper leg section, lower leg section, height adjustment, Trendelenburg position, length adjustment, length adjustment (only for Vis-a-Vis-bed) - approach all end positions	X*/M*				
	Angle limitation (back section to upper leg section -90°)	X*				
	Adjustment lower leg section (nurse/hydroflats/support plate)	X*				
	CFR function (if existing)	X*				
	Brake (electrical or mechanical)	X*				
	(only for hospital beds and S 280/S 310/S 380/S 280/S 302 (Vis-a-Vis))					
	Mechanical release (only for electrical brakes of hospital beds)	X*				
	9 V battery (only for beds with ONI-normal except S 660-1WS 6R1)	A2*				
	Replaced (years)	A*				
	Trapeze bar handle and ball (if existing)	B*				
Functional inspection miscellaneous	Replaced (years)	B*				
	Bed extension (if existing)	B*				
Comment	Bedding storage/bedding drawer (if existing)	B*				
	Inspection of the adhesive joints on headboard and footboard (if existing)	B*				
Total result of the inspection:	Signature of technician:	Next regular inspection:				
	Legally relevant for DIN EN 62323)	Loadage current by means of at least one terminal measurement ≤ 500 µA	µA			
	Percentage of equalization impedance ≤ 0.2 Ohm (if existing)	Ω				
A*: To be replaced every 5 years for handles (H) and for H with roll function (RF) in nursing home mode every 3 years for H with RF in hospital mode, every 2 years for H with RF for cleaning in automatic bed washing systems A2*: To be replaced every two years B*: Check for damage F*: Check for deformation M*: Check function of motors and end switches, does the motor switch off when reaching the end position? S*: Check for correct fit X*: General function control						

Spare Part Order/Repair Order

Spare part order

Repair order

Address: _____

Contact person: _____

Street address: _____

Zip code/city/country: _____

Telephone number: _____

Customer number: _____

Customer order number: _____

Purchase order date: _____

Signature: _____

(Please, to fill in the form use block letters)

Please, fill out all information carefully and complete in the form, otherwise we have problems in delivery and processing this order.

MODEL (Bed-type)	SERIAL NO./YEAR OF MANUFACTURE (identification label inside of the bed-head)	SPARE PART DESCRIPTION/ERROR DESCRIPTION	ITEM NUMBER	QUANTITY	LOCATION OF THE BED (only for repair order)

Contact person / telephone number for repair orders: _____

(Please, to fill in the form use block letters)

002024ENR 07.2017

The Völker GmbH inform you, that within the warranty period damages on the devices will be charged by us, if we detect non-intended use.

Völker GmbH
 Service
 Wullener Feld 79
 58454 Witten/Germany



Tel.: +49 2302 96096-0
 Fax: +49 2302 96096-66
 E-Mail: service@voelker.de

Shipping address, if differently from the billing address

Address: _____

Street address: _____

Zip code/city/country: _____

Attention of: _____

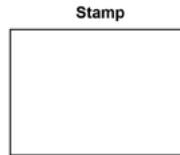

VÖLKER

Völker GmbH

Wullener Feld 79 · 58454 Witten/Germany

Telephone +49 2302 960 96-0 · Fax +49 2302 960 96-16

www.voelker.de · info@voelker.de